



**Jose D. Leon Guerrero Commercial Port of Guam
Master Plan Update 2007 Report**

Prepared for
The Port Authority of Guam

April 2008

Performed by
PB International, Inc.

Jose D. Leon Guerrero Commercial Port of Guam
Master Plan Update 2007 Report

Prepared for
The Port Authority of Guam

April 2008

Performed by
PB International, Inc.



Table of Contents

Executive Summary.....	12
E1.2 Socio-Economic Trends & Forecasts.....	12
E2.1 Commercial Port Access & Lands.....	12
E2.2 Apra Harbor & Navigation Infrastructure.....	12
E2.3 Existing Commercial Port Infrastructure.....	13
E3.1 Current Lease Agreements.....	13
E4.1 Cargo Forecasts.....	13
E4.2 Break-bulk Cargo Forecast.....	13
E4.3 Bulk Cargo.....	14
E4.4 Cruise Vessel Passengers.....	14
E5.1 Future Demands and Existing Capacity Constraints.....	15
E5.3 Alternate Terminal Location.....	15
E5.4 Container Terminal Alternatives.....	16
E5.6 Capital Cost Estimates for Selected Concept.....	18
E5.7 Federal & Local Permit and Approval Requirements.....	18
E6 Summary Recommendations.....	19
E6.1 Cargo Terminal Modernization.....	19
E6.2 Fishing Industry Operations and Warehouse #1 & #2.....	22
E6.3 Cruise Vessels & Passenger Traffic.....	23
E6.4 Cement Unloading.....	23
E6.5 Land Use & Zoning.....	24
E6.6 Port Security.....	26
E6.7 Marinas.....	26
E6.8 Terminal Facilities & Buildings.....	28
E6.9 Utility Improvements.....	28
E6.10 Lease Agreements.....	28
E6.11 Implementing Near Term Needs.....	29
Section 1 Introduction & Background Conditions.....	30
1.1 Introduction.....	30
1.2 Socio-Economic Trends & Forecasts.....	30
1.2.1 Population Trends & Forecasts.....	31
1.2.2 Economic Trends.....	35
1.2.3 Employment Trends & Forecasts.....	36
1.3 Port & Shipping Overview.....	43
1.4 Overview of Stakeholder Consultations.....	43
1.5 Overview of Data Collection Process.....	43



Section 2	Existing Port Environment.....	45
2.1	Commercial Port Access & Lands	45
2.1.1	Highway Access	45
2.1.2	Port Vicinity Road #11	45
2.1.3	Land Use Environment	48
2.1.4	Historic Preservation	49
2.2	Apra Harbor & Navigation Infrastructure	50
2.2.1	Navigation	50
2.2.2	Navigational Aids	52
2.3	Existing Commercial Port Facilities.....	53
2.3.1	Berths F-2 through F-6	58
2.3.2	Container Crane Rails on at Berths F-4, F-5 & F-6	59
2.3.3	Cargo Handling Equipment	60
2.3.4	Container & Cargo Storage Yard.....	61
2.3.5	Truck Gates.....	62
2.3.6	Fencing	62
2.3.7	Port Administration Building.....	63
2.3.8	Horizon Lines Building	64
2.3.9	Container Freight Station.....	65
2.3.10	Equipment Maintenance & Repair Building	66
2.3.11	Warehouses 1 & 2	68
2.3.12	Welding Shed	70
2.3.13	Description of Miscellaneous Buildings.....	71
2.3.14	Berth F1.....	72
2.3.15	Marine Industrial Terminal.....	73
2.3.16	Seaplane Ramp.....	74
2.3.17	Golf Pier	75
2.3.18	Hotel Wharf.....	75
2.3.19	Family Beach.....	77
2.3.19	Deep Draft Wharf.....	77
2.4	Commercial Port Area Utilities.....	77
2.4.1	Electrical Service & Load Center	79
2.4.2	Storm Water Drainage System.....	82
2.4.3	Sanitary Sewer System	82
2.4.4	Domestic Water System.....	82
2.4.5	Yard Lighting.....	83
2.4.6	Fire Protection System.....	83
2.4.7	Other Building Services.....	84



2.5	Operating Environment.....	84
2.5.1	Navigation Environment.....	84
2.5.2	Port of Guam Advantages.....	85
2.5.1	Container & Break Bulk Cargo.....	86
2.5.2	Fishing Industry Operations.....	90
2.5.3	Cruise Vessels & Passenger Traffic.....	90
2.5.4	Cement Unloading.....	90
2.5.7	Port Security.....	91
2.6	Marinas.....	92
2.6.1	Gregorio D. Perez Marina.....	92
2.6.2	Agat Marina.....	94
2.6.3	Harbor of Refuge.....	96
Section 3	Current Lease Agreements.....	99
3.1	Introduction and Methodology.....	99
3.2	Summary of Findings.....	99
Section 4	Cargo Forecasts.....	102
4.1	Containers.....	102
4.1.1	Description of Carrier Services.....	102
4.1.2	Container Trends & Forecast by User Group.....	104
4.1.3	Container Forecast by Trade Route.....	106
4.2	Break-bulk.....	109
4.3	Bulk Cargo.....	111
4.4	Cruise Vessel Passengers.....	112
Section 5	Alternatives Analyses.....	113
5.1	Future Demands and Existing Capacity Constraints.....	113
5.2	Planning Inputs.....	113
5.2.1	Vessel Size & Characteristics.....	113
5.2.2	Berth Length.....	114
5.2.3	Operating Template for a Modern Cargo Terminal.....	114
5.2.4	Planning Horizon & Timeframes.....	115
5.3	Alternate Terminal Location.....	115
5.4	Container Terminal Alternatives.....	115
5.5	Selected Alternative.....	117
5.5.1	Overview of Selected Alternative.....	117
5.5.2	Cargo Berthing Facilities.....	120
5.5.3	Container Cranes.....	121
5.5.4	Combined Wheeled + Grounded Operation.....	121
5.5.5	Flexibility for Extreme Demand Conditions.....	123



5.5.6	Conceptual Basis for Wharf Modernization Estimates	124
5.5.7	Demolition	124
5.6	Capital Cost Estimates for Selected Concept	128
5.7	Federal & Local Permit and Approval Requirements	128
5.7.1	List of Anticipated Federal & Local Permits	128
5.7.2	Federal Regulations Governing the Recommended Development	129
5.7.3	Local Regulations Governing the Recommended Development	129
5.7.4	Description of NEPA and the Permit and Approval Process	129
Section 6	Recommendations.....	131
6.1	Cargo Terminal Modernization	131
6.1.1	Terminal Land Area.....	131
6.1.2	Berth Modernization	131
6.1.3	Design Vessels.....	132
6.1.4	Ship to Shore Container Cranes.....	132
6.1.5	Cargo Storage Yard & Configuration of Terminal Area	133
6.1.6	Container Handling System	133
6.1.7	Yard Flexibility for Extreme Demand Conditions.....	134
6.1.8	Truck Gate	134
6.1.9	Minimum Equipment Requirements.....	135
6.1.10	Terminal Operating Systems	135
6.1.11	Labor Availability & Productivity.....	136
6.1.12	Separate Access for Non-Cargo Related Operations.....	136
6.2	Fishing Industry Operations and Warehouse #1 & #2	136
6.3	Cruise Vessels & Passenger Traffic	137
6.4	Cement Unloading	137
6.5	Land Use & Zoning.....	138
6.5.1	Recommended Land Use Changes	141
6.5.2	Other Land Use Designations Remain Unchanged.....	141
6.5.3	Conveyance of Ancestral Lands	141
6.6	Port Security.....	142
6.6.1	Current Security Conditions	142
6.6.2	Commercial Terminal, Cargo Handling, and Cruise Ship Requirements	143
6.6.3	Port Operations Security Requirements	143
6.6.4	Commercial Terminal, Cargo Handling, and Cruise Ship Facilities Solutions.....	144
6.6.5	Public Facilities	148
6.6.6	Military Facilities.....	148
6.6.7	Implementation Plan	148
6.7	Marinas	148



6.7.1	Gregorio D. Perez Marina.....	149
6.7.2	Agat Marina.....	150
6.7.3	Harbor of Refuge.....	150
6.8	Terminal Facilities & Buildings.....	151
6.9	Site Utilities.....	152
6.10	Tenants & Lease Agreements.....	154
6.10.1	Current Lease Agreements.....	154
6.10.2	Recycling Enterprise Zone.....	154
6.10.3	Cabras Island Industrial Park.....	154
6.10.4	Lease Agreements to Encourage Facility Investments.....	155
6.11	Implementing Near Term Needs.....	155
Appendix 1-1	Master Plan Update Scope.....	156
Appendix 1-2	Meeting Notes.....	163
Appendix 1-3	Data Collection.....	215
Appendix 2-1	Facility Assessment Methodology & Limitations.....	222
Appendix 2-2	Select Building Drawings.....	226
Appendix 2-3	Photographs.....	235
Appendix 3-1	Tabulation of Lease Agreements.....	340
Appendix 4-1	Comparison of Alternatives.....	345
Appendix 5-1	Public Presentations & Comments.....	354

Figures

Figure E4.1-1	Container Forecasts (Containers).....	13
Figure E4.2-1	Guam Break-bulk Trends & Forecasts (Revenue Tons).....	14
Figure E4.3-1	Guam Bulk Cement Imports (Tons).....	14
Figure E5.5-2	Selected Terminal Alternative - Break-Bulk WEST Variation.....	17
Figure E6.5-1	Recommended Land Use Change.....	25
Figure 1.2-1	Guam Civilian Population Trends & Forecasts.....	31
Figure 1.2-2	Current Force Levels on Guam (2007).....	32
Figure 1.2-3	Future Force Levels on Guam (phased in by 2016).....	33
Figure 1.2-4	Civilian & Military Employment Trends in Guam (number of employees).....	36
Figure 1.2-5	Employment Trends.....	37
Figure 1.2-6	Guam Visitor Trends & Forecasts.....	38
Figure 1.2-7	Construction Activity on Guam (Sales in \$1,000s of 2007\$).....	40
Figure 1.2-8	Construction Employment on Guam.....	40
Figure 1.2-9	Tuna Trans-shipments via Guam.....	41
Figure 1.3-1	Port Property Location Map.....	42
Figure 1.4-1	List of Meetings.....	44
Figure 2.1-1	Commercial Port Location & Access.....	46
Figure 2.1-2	Commercial Port & Vicinity Land Use Designations.....	47
Figure 2.2-1	Apra Harbor.....	51
Figure 2.3-1	Guam Commercial Port Facilities Location Map.....	55
Figure 2.3-2	Cargo Terminal Area Buildings Structures.....	56
Figure 2.4-1	GPA Power Supply Schematic for PAG.....	80
Figure 2.5-1	Historical Ship Traffic in Apra Harbor.....	85



Figure 2.5-2	Typical Weekly Service Demand Patterns	87
Figure 2.5-3	Representative Berth Occupancy (May 2007).....	88
Figure 4.1-1	Matson Service to Guam	102
Figure 4.1-2	Horizon Service to Guam	102
Figure 4.1-3	Kyowa Service to Guam.....	103
Figure 4.1-4	Port of Guam Container Trends (TEUs).....	104
Figure 4.2-1	Guam Break-bulk Trends & Forecasts (Revenue Tons).....	109
Figure 4.3-1	Guam Bulk Cement Imports (Tons)	111
Figure 5.5-1	Terminal Alternative - Break-Bulk EAST Variation.....	118
Figure 5.5-2	Selected Terminal Alternative - Break-Bulk WEST Variation	119
Figure 5.5-3	Wharf Concept for Capital Cost Estimates at New F-7 Area	125
Figure 5.5-4	Wharf Modernization Concept Assumed for Cost Estimates for Area B	126
Figure 5.5-5	Wharf Modernization Concept Assumed for Cost Estimates for Area C	127
Figure 6.5-1	Recommended Land Use Change.....	139
Figure 6.5-2	Creation of New Industrial Land	140
Figure A5.1-1a	Concept Layout – RTG System	346
Figure A5.1-1b	Ground Slots & Equipment Needs - RTG.....	347
Figure A5.1-2a	Concept Layout – Wheeled + Top-Pick System	348
Figure A5.1-2b	Ground Slots & Equipment Needs – Wheeled + Top-Pick	349
Figure A5.1-3a	Concept Layout – Top-Pick System.....	350
Figure A5.1-3b	Ground Slots & Equipment Needs – Top-Pick	351
Figure A5.1-4a	Concept Layout – Reach Stacker System	352
Figure A5.1-4b	Ground Slots & Equipment Needs – Reach Stacker	353

Tables

Table 1.2-1	Population Trends & Forecasts	34
Table 1.2-2	Sales by Class of Customer (\$1,000s) in 2002	35
Table 1.2-3	Guam Import Data (Current Dollars)	35
Table 1.2-4	DOD Projected Construction Expenditures.....	39
Table 1.2-5	Population Trends & Forecasts at Neighboring Islands	42
Table 2.3-1	Commercial Port Areas	53
Table 2.3-2	Berth Overview & Metrics	54
Table 2.3-3	List of Cargo Handling Equipment	60
Table 2.3-4	Port Admin Building Tenants.....	63
Table 2.3-5	Horizon Office Building Tenants	64
Table 2.3-6	Container Freight Station Building Tenants	66
Table 2.3-7	Warehouses 1 & 2 Tenants.....	68
Table 2.3-8	Oil Tank Farm Area Tenants.....	74
Table 2.4-1	List of Major Site Utilities.....	78
Table 2.5-1	Historical Vessel Calls	85
Table 2.5-2	Parameters - Representative Current Ships Calling at PAG	86
Table 3.2-1	Summary of Major Lease Agreements.....	100
Table 4.1-1	Vessel Call Summary for 2007 (Jan through mid-Aug).....	104
Table 4.1-2	Guam Container Traffic Forecast – By Source (Boxes).....	106
Table 4.1-3	Guam Container Traffic Forecast – By Route (Boxes)	108
Table 4.2-1	Guam Break-bulk Cargo Forecast (Revenue Tons).....	110
Table 4.4-1	Port of Guam Passenger Vessel Visitor Trends.....	112
Table 5.1-1	Capacity Constraints by Type of Annual Cargo.....	113
Table 5.2-1	Class of Container Vessels in Service	114
Table 5.2-1	Yard System Capacity Comparison of Alternatives	116



Table 5.5-1	Berth Depths after Modernization	120
Table 5.5-2	Cargo Berth Service & Utilization Analysis – Peak Year 201599 (Rev “Per Call”).....	120
Table A1.3-1	List of Collected Data.....	216
Table A3-1.1	Key Index for Tabulation of Lease Agreements.....	341
Table A3-1.2	Tabulation of Lease Agreements.....	342



Abbreviations

BSP	Bureau of Statistics & Plans
CFS	Container Freight Station
CIS	Container Inspecting Station
CMU	Concrete Masonry Unit
CNMI	Commonwealth of the Northern Marianas Islands
CT	Cargo Terminal
C-TPAT	Customs-Trade Partnership against Terrorism
CTSI	CTSI Logistics
CZM	Coastal Zone Management
DOD	Department of Defense
DOL	Department of Labor
DPW	Department of Public Works
DWT	Dead Weight Tons
EDI	Electronic Data Interchange
EIR	Equipment Interchange Report
ESQD	Explosive Safety Quantity Distance
FGS	Forty Foot Ground Slot
FSM	Federated States of Micronesia
FY	Fiscal Year
GEDCA	Guam Economic Development and Commerce Authority
GIS	Geographic Information System
GPA	Guam Power Authority
GPM	Gallons Per Minute
GRT	Gross Revenue Tons
GWA	Guam Water Authority
HP	Horse Power
HUD	Housing & Urban Development
ISPS	International Ship and Port Facility Security
JDLG	Jose D. Leon Guerrero
LAN	Local Area Network
LC	Load Center buildings
LOA	Length Overall
LT	Long Ton
MEL	Marianas Express Lines
MEP	Mechanical Electrical & Plumbing
MI	Marianas Islands
MPH	Miles Per Hour
MT	Metric Tons
MT	Empty Boxes
MTSA	Maritime Transportation Security Act
MVA	Mega Volt Ampere
MXS	Micronesia Express Service
NAVFAC	Naval Facilities Command
NAVIS	NAVIS Software
NOAA	National Oceanic & Atmospheric Administration



OCR	Optical Character Recognition
OOG	Oversized (Out Of Gage) Boxes
PAG	Port Authority of Guam
PFSP	Port Facility Security Plan
PMX	PANAMAX
PPMX	Post PANAMAX
PTZ	Pan Tilt Zoom
RC	Reinforced Concrete
RCP	Reinforced Concrete Pipe
RFID	Radio Frequency Identification
RTG	Rubber Tire Gantry Crane
SARS	Severe Acute Respiratory Syndrome
SBH	Small Boat Harbor
SDDC	Military Surface Deployment and Distribution Command
SPH	Sewer Pump House
ST	Short Ton
TBD	To Be Determined
TEU	Twenty Equivalent Unit
TGS	Twenty Foot Ground Slot
TWIC	Transportation Worker Identification Credential
UBC	Uniform Building Code
UNWTO	United Nations World Tourism Organization
USACE	U.S. Army Corps of Engineers
USCG	US Coast Guard
USD	Ultimate Strength Design
USDA	US Department of Agriculture
USWC	US West Coast
WAMS	Waterways Analysis and Management System
WH	Warehouse
WSD	Working Stress Design
XLPE	Cross-linked Polyethylene



Executive Summary

Guam is an unincorporated territory of the United States. It is the largest island in the Marianas Archipelago in the Pacific Ocean. Its population is currently some 173,000 comprising mostly civilians but also military personnel and their dependents from the U.S. military bases located on the island. Guam's enabling act of the Jose D. Leon Guerrero Commercial Port or Port Authority of Guam (the Port or PAG) calls for the Port to provide for the needs of ocean commerce, shipping, recreational and commercial boating and navigation of the territory of Guam. The Port Authority of Guam performs a crucial and indispensable role in the lives of the civilian and military population of Guam, the military bases and neighboring islands in the north-pacific region. Some 90% of the day to day goods and supplies consumed by its constituencies pass through the Port.

On August 7, 2007, the Port Authority of Guam commissioned PB International, Inc. (The Consultant) to update the Port's Master Plan to include an Impact Assessment on the Port Authority of Guam Facilities due to relocation of Okinawa-based Military personnel and related ancillary activities and major developments affecting Guam. This will result in a substantial increase to the population base as well as construction activity for base construction and development of Guam's infrastructure.

This report describes the Consultant's activities, analysis and findings on the Master Plan Update for the Port Authority of Guam.

E1.2 Socio-Economic Trends & Forecasts

The consultant team reviewed the Socio-Economic trends in Guam in order to understand the impacts on the commercial port. The primary economic sectors on Guam are tourism and the Department of Defense (DOD). In addition, cargo activity is also driven by the local population base, construction (supporting both civilian and military) and transshipment to neighboring islands.

Guam's civilian population is expected to grow from 173,456 persons in 2007 to 182,000 by the year 2018. Guam's military population (including active duty personnel and their dependents) stood at approximately 14,110 persons in 2007. The DOD is projecting a future deployment on Guam of 38,070 active duty and dependents. This represents an increase of 23,960 persons over current levels, including 12,510 active duty personnel and 11,450 dependents.

Section 1.2 includes a detail assessment of recent population, economic, employment trends and forecasts for Guam and the neighboring islands that are expected to drive port activity.

E2.1 Commercial Port Access & Lands

The Commercial Port facilities owned and managed by the Port Authority of Guam as shown on the aerial view on Figure 2.1-1, are located along the Northern shoreline of Apra Harbor close to Piti. Access from Tamuning and other urban areas is via the four lane main arterial, Route 1, or Marine Corps Drive which at this point runs Southwesterly towards Piti. Access to the Commercial Port from Piti is via the two lane road Route 11. The Commercial Port lands administered by the Port and applicable current Land Use designations as approved by the legislature in 2000 are described in Section 2.1.3 and depicted in graphical form in Figure 2.1-2.

E2.2 Apra Harbor & Navigation Infrastructure

The Consultant reviewed the navigation infrastructure in Apra Harbor. Guam has the advantages of an effective and proven breakwater & sheltered harbor, deep water anchorages & navigation channel and navigational aids as described in Section 2.2.



E2.3 Existing Commercial Port Infrastructure

The Commercial Port facilities are largely in Industrial Zones with no urban encroachment, land & waterfront access for cargo terminal expansion. The Port also has the advantages of major Shipping Line rotations between the U.S. West Coast (USWC) and the Far East, Asian Services & Island Transshipment Services. Descriptions of the various Commercial and Tenant Port facilities and equipment are presented in Section 2.3, Existing Commercial Port. The Consultant's review showed that the Commercial Cargo facilities are aging and in need of substantial renovation and modernization.

E3.1 Current Lease Agreements

The Port Authority of Guam (PAG) currently has leases and agreements for facilities with over 50 companies and in many cases, multiple leases with the same company covering different facilities. Managing the leases and properties is a major business activity of PAG.

The review showed that, within the boundaries of the current general cargo terminal, none of the leases posed a serious impediment to potential facility redevelopment since the agreements are month to month. The GEDCA lease with CASAMAR, assigned to PAG, for facilities at berth F-2 is an exception to the above. This lease still has more than 40 years to run and the tenant in an interview expressed no desire to move. As long as the tenant continues to meet its obligations, there is little redevelopment that can be done in this area. See Section E6.10 for additional recommendations regarding leases.

E4.1 Cargo Forecasts

The Consultants forecast for container movement through the Port are shown pictorially in Figure E4.1-1. From current levels, it forecasts a substantial increase in the number of containers that must be handled by the Port over the next 20 years. Movement in lifts (containers) will increase from the current levels of 103,000 to a peak of 190,000 during the proposed Navy base construction program before settling at a higher plateau represented by 163,000 in the year 2027.

E4.2 Break-bulk Cargo Forecast

In 2007 the Port handled 155,000 Revenue Tons of Break-bulk. Volumes (i.e., the portion that includes construction materials) are expected to increase dramatically in response to the DOD build-up, growing present volumes to around 270,000 to 320,000 revenue tons during the period from 2010 through 2013. After the construction period, inbound break-bulk is expected to grow from 109,000 revenue tons in 2015 to 121,000 revenue tons in 2027 or at around 0.8 percent per year. See Table 4.2-1.

Figure E4.1-1 Container Forecasts (Containers)

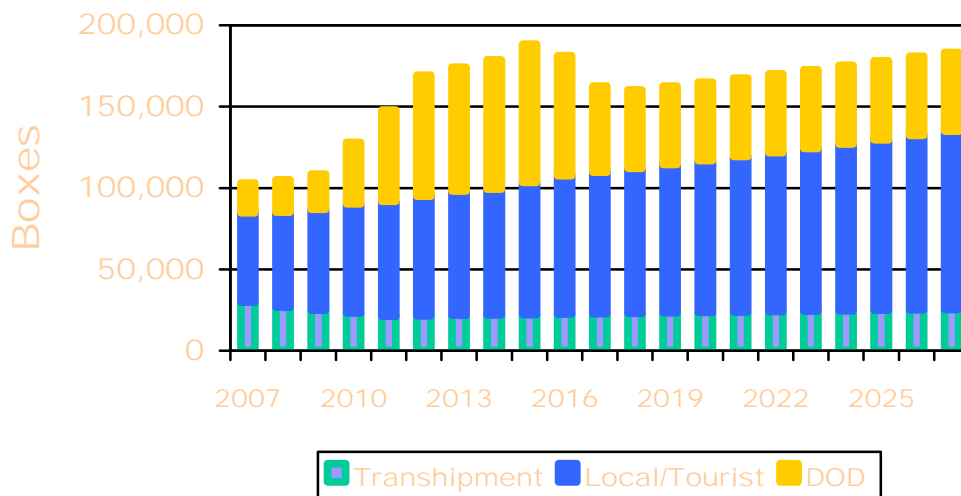
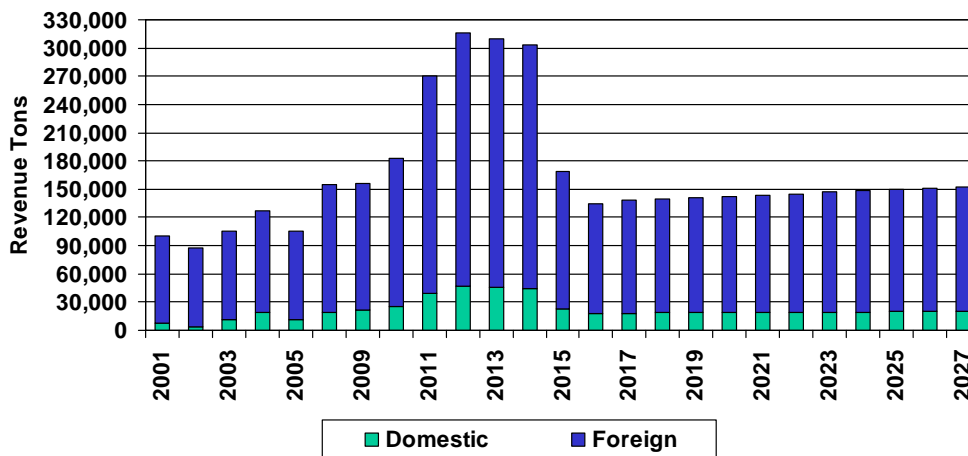



Figure E4.2-1 Guam Break-bulk Trends & Forecasts (Revenue Tons)



E4.3 Bulk Cargo

There are bulk imports of cement to Guam of approximately 100,000 tons per year at the present time. As depicted in Figure E4.3-1, bulk cement imports are also expected to increase dramatically with the DOD construction build-up to 250,000 to 500,000 tons per year during the period 2010 to 2013. After the construction is completed, bulk cement imports are expected to return to 90,000 to 110,000 tons per year. The uncertainty about the construction process and the lack of specific details for specific projects are the main reasons for the variation between the low and high forecast volumes. As construction contracts are finalized, the bulk cargo forecasts should be re-evaluated.

Figure E4.3-1 Guam Bulk Cement Imports (Tons)

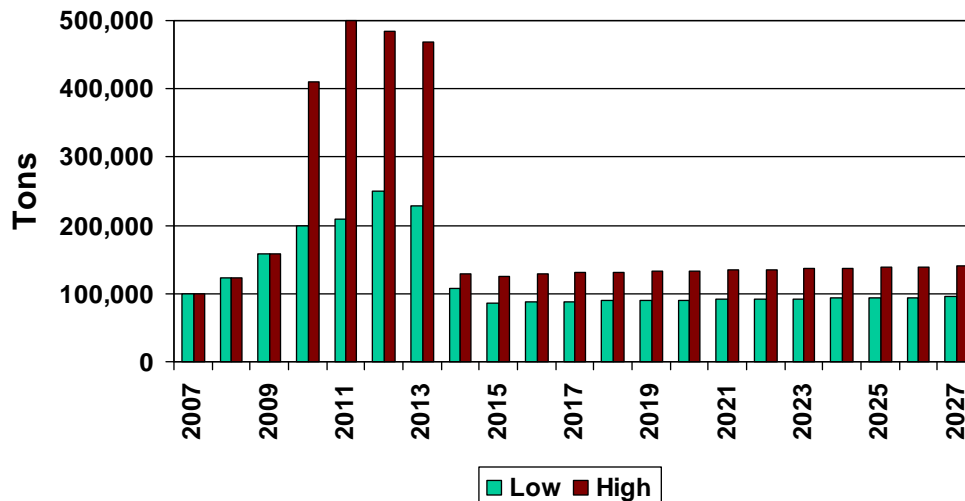

E4.4 Cruise Vessel Passengers

Guam has received around 6 to 8 calls on average per year in the recent past with approximately 600 passengers per call. The overall forecast for world cruise activity is projected at around 4.5% to 5.5% in



next ten years then decreasing to 3.5% to 4.5% during the period 2017 to 2027, according to the Cruise Line International Association. Cruising is expected to grow at a slightly faster rate than overall tourism.

Recently, several cruise lines have expressed an interest in expanding cruise operations in Guam. The lines are looking to differentiate themselves by offering unique venues. They are interested in expanding into Asia and other world destinations, particularly to exotic, interesting and intriguing locations. If successful, Guam could attract 20 to 30 calls per year in the next five years. This will require a concerted effort to achieve, including improved port facilities such as streamlined security and passenger screening facilities and improved visitor attractions.

E5.1 Future Demands and Existing Capacity Constraints

The Throughput Capacity of a cargo terminal can be constrained at different locations in the cargo transportation system. The composite picture presented by current below-industry production rates, the likely limited remaining service life for aged equipment, and the absence of modernized terminal and gate operating systems leads us to conclude that existing facilities and systems will not be able to support the Cargo Forecasts described in Section 4.

We selected the peak demand year needs and compared it to our capacity estimates for each of the types of cargo. Accordingly, Capacity Constraints “As Is” with Current Trade Patterns may be summarized as follows.

Containers

□ Highest Throughput Yr 2007	103,000 Lifts	175,000 TEU
Est. Capacity	120,000 Lifts	204,000 TEU
Peak Future Demand	190,000 Lifts	323,000 TEU (in 2015)

Shortfall in Peak Year	70,000 Lifts	

Break-bulk

□ Highest Throughput Yr 2006:	155,000 Tons
Est. Capacity	Close to Capacity
Peak Future Demand	316,000 Tons During Construction

Shortfall in Peak Year	161,000 Tons

Cement

□ Highest Throughput Yr 2006:	100,000 Tons
Est. Capacity	125,000 Tons
Peak Future Demand	250,000 Tons During Construction

Shortfall in Peak Year	125,000 Tons (See Section 6.4 for high forecast implications)

Liquid Fuels

- Have Excess Capacity (See discussion with Oil Companies)

Cruise Vessel Calls

- Need Improvements to Facilities

It is clear that major capacity improvements must be implemented in order to address the future demands for the Commercial Cargo Terminal and for Cement Imports.

E5.3 Alternate Terminal Location

One of the first questions that must be addressed when planning a modernization program is whether it is better to relocate to a new green-fields site or is it more feasible and economical to modernize at the same location. This question was quickly put to rest for PAG for several reasons including considerable



costs, lack of available land, time-frame for environmental studies and execution and the presence of considerable assets (albeit outdated) available at the current location to facilitate modernizing the Cargo Terminal in place more quickly and more economically. Because of the above considerations, the “green-fields” alternative was not considered for the cargo terminal.

E5.4 Container Terminal Alternatives

Terminal Layout and design is driven not only by the physical layout of the property and transportation infrastructure but also by the type of container handling system chosen by the Terminal Operator. Four container handling systems were used as the basis for developing terminal layouts. The following systems were considered reasonable for the type and size of the terminal.

- Rubber Tired Gantry (RTG) System
- Combination Wheeled + Top-Pick System
- Top Pick System
- Reach Stacker System

These alternatives were analyzed on a preliminary basis for the cargo demand for the peak year, 2015. The Consultant did not find any fatal flaws in any of these alternatives. Some alternatives such as the “Combination Wheeled + Top-Pick” system were land intensive and certain operational adjustments would have to be made to address peak cargo throughput conditions. Others, such as the Reach-Stacker options, were not as familiar to the Port operating staff.

Upon completion of the analyses a comparative estimate of capital costs was developed. The results were discussed with the Port Management and Staff, Shipping Lines and other stakeholders as appropriate. PAG selected the “Combination Wheeled + Top-Pick System” as the preferred alternative. The Terminal Layout Alternative selected by PAG is depicted in Figures E5.5-2 with the major features identified in the legend. More information on the selected alternative is presented in Section 5.5.

Figure E5.5-2 Selected Terminal Alternative - Break-Bulk WEST Variation

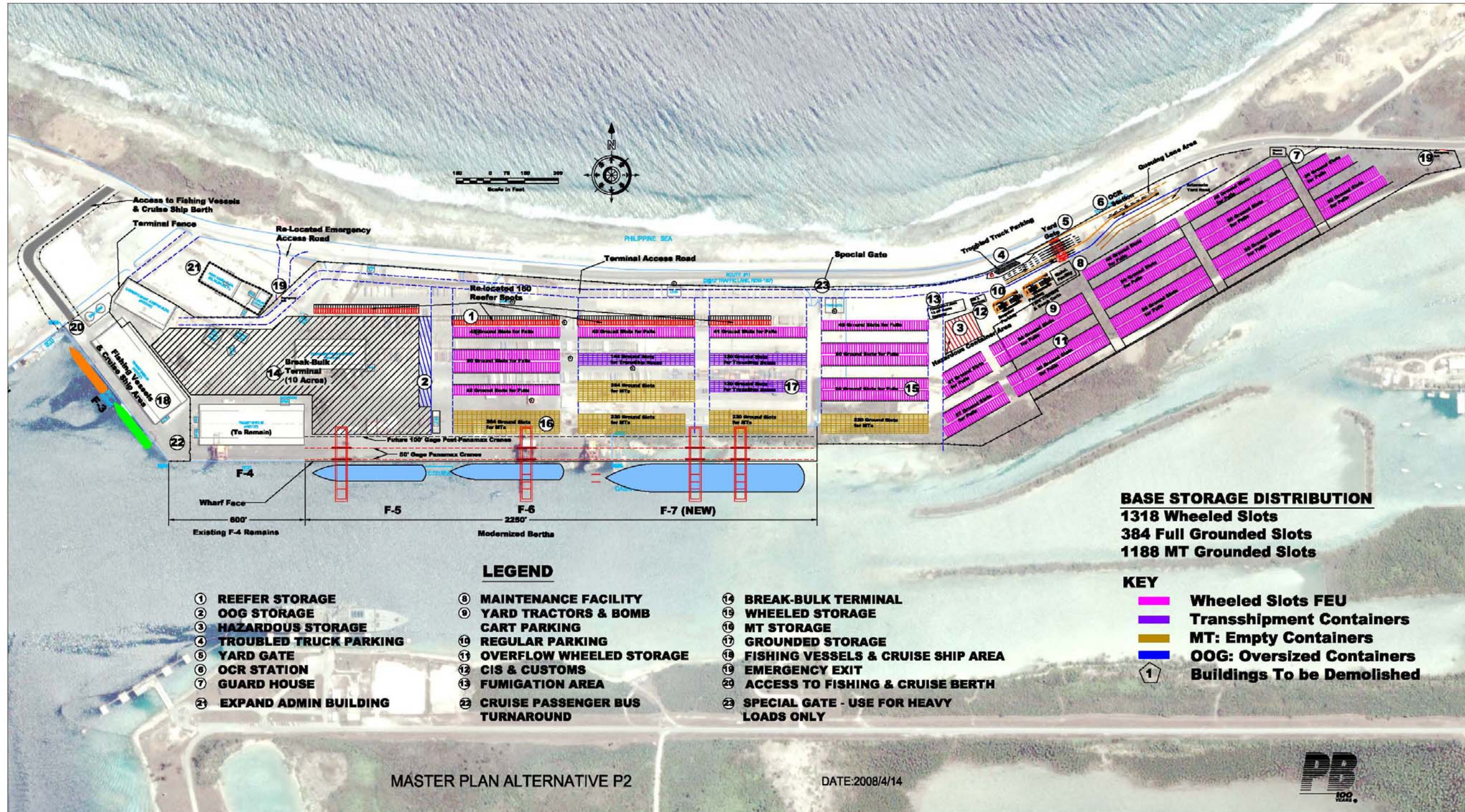



E5.6 Capital Cost Estimates for Selected Concept

Capital cost estimates for construction and commissioning of the facilities, equipment and amenities that are required to implement the preferred concept "Break-Bulk West" (Figure 5.5-2) described in this report were prepared on a conceptual basis. The estimate of Capital Costs by Major line item is presented below.

ITEM DESCRIPTION		Budget Estimate
Mobilization and Demobilization		\$ 6,640,000
All Other Contract Work not stated below		\$ 2,180,000
Demolition		\$ 7,510,000
Berth F-5 to F-7 Modernization		\$ 34,290,000
Buildings		\$ 7,950,000
Terminal Paving		\$ 14,600,000
Power, Lighting & Electrical		\$ 10,280,000
Site Utilities		\$ 20,110,000
Security		\$ 7,740,000
Container Cranes		\$ 14,500,000
Top-Picks & Spreaders		\$ 2,900,000
Side-Picks		\$ 1,500,000
Other Yard Equipment		\$ 3,700,000
Terminal Operating System		\$ 2,500,000
Gates		\$ 2,500,000
		\$ -
CAPITAL COST ESTIMATE TOTAL		\$ 138,900,000
Contingency	25%	\$ 34,900,000
Engineering/Permits/CM	15%	\$ 21,200,000
TOTAL		\$ 195,000,000

The above estimate includes all costs related to facilities that would normally be provided within a Commercial Cargo Terminal by the Port and Terminal Operator. Facilities and equipment normally provided by State (other than PAG) or Federal agencies are not included. These would include CIS, Customs Building and Scanning Equipment, Agriculture Inspection and Fumigation Facilities and other inspection and enforcement facilities. The estimate is also based on the acquisition of three used PANAMAX Cranes as discussed in this report. Financing costs such as prepaid interest and any fees associated with acquisition of Federal funds or Private or Bond financing are also not included in the above estimate.

E5.7 Federal & Local Permit and Approval Requirements

It is anticipated that the following environmental permits and approvals will be required to implement the Recommended Development:

Federal Permits and Approvals:



- National Environmental Policy Act (NEPA) completion
- US Army Corps of Engineers (USACE) Section 10/404 Permit

Local Permits and Approvals:

- Guam EPA (GEPA) administered Section 401 Water Quality Certification
- Guam Bureau of Statistics and Plans (BOSAP) Coastal Zone Management Program Consistency
- Guam Development Permit (if dredging seaward of the mean high water (MHW) line)
- GEPA Erosion Control Plan Approval/Permit
- GEPA Environmental Protection Plan (EPP) Approval
- GEPA administered National Pollution Discharge Elimination System (NPDES) storm water general permit for construction activities
- GEPA Test Boring Permit
- GEPA Dewatering Permit (if needed)

E6 Summary Recommendations

This Master Plan Update was performed for a planning horizon of 20 years with the start year of 2008. Within this planning horizon the Consultants recommendations will use the following terminology for near term and long term recommendations.

Near Term July 2010 Based on Military's estimate for base construction start.

Long Term Occurs some 10 to 15 years into the planning horizon.

Where a recommendation does not specifically state "Near Term" or "Long Term" the recommendations applies to the Near Term.

It is also important to reiterate that the nature of planning requires that updates be performed in the future from time to time in order to validate and refine the recommendations made and address developments that cannot be forecast at this time.

E6.1 Cargo Terminal Modernization

We recommend that the Commercial Port Cargo Terminal on Cabras Island be modernized and expanded in its current location to address the increased cargo throughput anticipated over the planning horizon. The facility improvements should be designed to support the following minimum annual cargo throughput volumes.

Containers / Year	200,000 Lifts
Break-bulk Cargo / Year	350,000 Tons

Recommendations on the need for expansion of Cement unloading are presented later in this section. We do believe that with proper maintenance and upkeep there are sufficient liquid fuel unloading capabilities available in Commercial Port area.

E6.1.1 Terminal Land Area

We recommend that the current terminal areas and the designated cargo terminal expansion areas be utilized for this modernization program. This would encompass the area designated "CT" in the current land use map shown on Figure 2.1-2, Section 2.

E6.1.2 Berth Modernization

We recommend that a minimum 2,250' of refurbished and new wharves be constructed at the terminal as shown in Figures Figure E5.5-1. This would consist of a 900' new Berth F-7 wharf located east of the existing berths and refurbishment and modernization of 1,350' at existing Berth F-5 and F-6. We recommend that Berths F-2, F-3 and F-4 be provided proper maintenance and upkeep for use by smaller vessels. The following berth depths are recommended.



Berth Depths after Modernization

Berth	Near-Term	Long-Term
F-4	No Change	No Change
F-5	-37'	-37'
F-6 (West)	-37'	-37' (Refurbished in 1998)
F-6 (East)	-42'	-51' (Eastern 415')
F-7	-42'	-51'

The above metrics should provide one contiguous 1,315' berth at the East end of the terminal that would be dredged to -42' in the Near Term and designed for -51' in the Long Term.

The current 15.8m Apra Harbor Navigation Channel design depth designation should be maintained to support these Long Term berth needs.

E6.1.3 Design Vessels

We recommend that the berths be designed to support the following minimum representative design vessel sizes.

Short Term Minimum Design Vessels

Classification	TEU	LOA (Feet)	Draft (Feet)	Beam (Feet)	Width (Container)	DWT
Handy Size	2,200	640	33	93	11	25,000
Maunawili	2,600	712	41	105.6	13	37,752
Horizon Hunter	2,824	729	39	98	12	39,266
LMSR Military Vessel	N/A	950	37	105.6	N/A	34,000

Long Term Minimum Design Vessels (Applies to F-6 East & F-7 only)

Classification	TEU	LOA (Feet)	Draft (Feet)	Beam (Feet)	Width (Container)	DWT
Post Panamax	4,800	900	45	135	16	90,000
Super Post Panamax	8,000	1,150	48	150	18	100,000

E6.1.4 Ship to Shore Container Cranes

We recommend the acquisition and installation by purchase, lease or other third party supply agreement three (3) used PANAMAX Cranes (PMX Cranes) in good condition in the Near Term. Upon acquisition of these cranes, we recommend the scrapping and removal of the two older cranes leaving the existing "Subic" crane in order to offer a total of four (4) cranes for berth service. The crane rail system should be upgraded to support these 50' gage PMX Cranes for the Near Term.

We recommend developing the berth apron and adjacent area to support the use of 100' gage Post-PANAMAX Cranes (PPMX Cranes) in the Long Term. These new cranes would be purchased and put into service at the appropriate time to service the Long Term Design Vessels.

E6.1.5 Cargo Storage Yard & Configuration of Terminal Area

We recommend reconfiguring the terminal area to relocate all activities and personnel not directly required for cargo handling operations to a location outside the terminal fence. One conceptual configuration is depicted on Figures E5.5-1. Tenants with non-cargo related functions such as Fishing Industry operations and cruise vessel calls would have a separate access at the west end of the terminal. The Admin Building and Warehouse Sheds #1 will be located outside the fence.

We recommend the refurbishment of the existing yard area behind the berths as for cargo storage to meet modern cargo handling requirements. This will include upgrade of the pavement as well as all new utilities and high mast lighting with energy efficient systems to support both operations and security



considerations. We recommend relocating the existing fuel line running through the terminal to an appropriate routing outside the cargo yard.

The currently vacant expansion area to the east should be developed to support terminal cargo storage requirements. This will include paving and all utilities and lighting for operation as a cargo storage yard.

A new truck entry and exit gate should be constructed in the expansion area generally as shown in Figures 5.5-1 and 5.5-2. Other facilities and amenities that should be included within the cargo terminal fence are identified on the legend in Figure E5.5-1.

In order to accommodate configuration changes, we recommend demolition of certain existing buildings and relocation of functions currently performed from these buildings to another area. The proposed structures for demolition are identified in Figure E5.5-1.

E6.1.6 Container Handling System

The container handling system selected by PAG for further planning and the one preferred by the USWC shipping lines is a combination "Wheeled" and "Grounded" system akin to the current operation. The Consultant's recommendations linked to yard design were developed on the basis of the above container handling system.

Public Law 27-60 and Public Law 29-23 allow for the Port Authority of Guam to either enter in a contract with a terminal operator or enter into a public private partnership through a performance management contract for the management, operation and maintenance of the port cargo handling equipment and/or facilities associated with such equipment and/or other aspects of port operations. .. It should be mentioned that if this were to take place, such terminal operators or private partners often have a preference for a particular type of container handling system.

E6.1.7 Yard Flexibility for Extreme Demand Conditions

For the "Wheeled plus Grounded" operation under certain extreme operating conditions the number of Wheeled Slots that can be accommodated in the terminal area may not be adequate. These conditions could include peak shipments arriving the same week, turnaround of Shipping Line chassis in Guam, insufficient chassis availability, higher than anticipated peak demand for break-bulk project cargo during base construction.

Therefore we recommend that a portion of the "Wheeled Chassis" storage areas be designed for stacked heavier container storage equipment loads so that these areas can be used as stacked container storage areas under these peak conditions.

E6.1.8 Truck Gate

We recommend demolition of the existing gate and construction of a new Truck Gate at the location shown on Figure E5.5-1. We recommend implementation of semi-automated gate design that can process container trucks in a fast efficient fashion.

This will require several facility and system features in order to incorporate and maintain. While final design will depend on a number of issues for discussion with the Port, Shipping Lines and Vendors during design implementation, it is recommended that the features discussed in Section 6.1.8 are considered, analyzed and adopted as needed.

E6.1.9 Minimum Equipment Requirements

For the Container Handling System assumptions discussed in Section 6.1.6, we recommend equipping the terminal with the following minimum list of equipment.

Equipment:	Ea.
Container Quay Cranes - Existing	1
Container Quay Cranes - Additional	3
Top Picks	5
Yard Tractors - Existing	8
Yard Tractors - Additional	17
Yard Chassis	50
Side Picks (Empties)	6
B/B Ship Cranes	2
Mafi Trailers	8
Forklifts 30T	1
Forklifts 10T	1
Forklifts 7.5T	2
Forklifts 5T	6
Shipper Supplied Chassis*	As Needed
*By S/L or Consignee	

Based on the demand cargo forecast presented in Section 4 and the selected container handling system, the above minimum list of equipment will be required for the entire planning horizon. Note that unless specifically labeled as existing, all other equipment would have to be acquired by the Port or entity operating the terminal.

E6.1.10 Terminal Operating Systems

It is recommended that the Port transition to a proven vendor-furnished Terminal Operating System compatible with systems used by major shipping lines and terminals. These would include.

- Terminal Management and Operating System with Invoicing System
- Integration or Interface a Financial Management System and
- If preferred by the Port a Maintenance Work Order System (Equipment and Building)
- Gate Automation System

E6.1.11 Labor Availability & Productivity

The capacity planning and analysis for developing the recommendations in this report were based on the ready availability of trained labor to address peak cargo handling operations. We therefore recommend that PAG set up an organizational scheme that can furnish skilled labor for the various tasks and activities at the modernized PAG terminal and meet peak demands. We also recommend that professional training be provided to the various categories of skilled labor in order to operate using new technologies, procedures and equipment consistent with a modern container terminal.

E6.1.12 Separate Access for Non-Cargo Related Operations

Terminal layouts in Figures 5.5-1 and 5.5-2 show a separate terminal access for non-cargo related tenants at Berth F-3. It would very likely be necessary to renegotiate a strip of right of way along the Northeast edge of the CASAMAR lease property area in order to implement this and separate the non-cargo and commercial cargo terminal operations. As described below the above proposal will provide a separate entrance to the Fishing Industry operations at Berth F-3, Cruise Passengers and Warehouse #1. Access to the Commercial Cargo Terminal and Warehouse #2 will be through the new Truck Gate towards the east. We recommend that these facilities be separated as described.

E6.2 Fishing Industry Operations and Warehouse #1 & #2

The Terminal Layout Design shown in Figures E5.5-1 demonstrates the viability of providing cargo handling facilities at the terminal without the need to include Warehouse #1 within the terminal boundary. A number of Long-liner Fishing support businesses are located in this building. The scheme also does not affect their berthing access to F-3. With the proposed new wharf extension the Port will



have sufficient berthing at F-4, F-5, F-6 and F-7 to support commercial cargo terminal related vessel operations.

Since the Cruise Vessel calls are not expected to increase to dramatically high volumes in the Near Term, F-3 should continued to be shared by these two types of users. Warehouse #1 will also be outside the Commercial Cargo Terminal area. Therefore we do not see the immediate need to relocate the Fishing Industry tenants in Warehouse #1 with commensurate under utilization of F-3 and Warehouse #1 and loss of revenue to the Port. Non-berth operations related businesses in Warehouse #1 should be relocated away from the port area.

We recommend that all operations in Warehouse #2 which are not directly related to cargo handling be moved outside the Commercial Cargo Terminal fence. This will include the non-cargo related Port staff and the Fishing Industry tenants in Warehouse #2. The Port staff with direct Cargo related functions would remain in Warehouse #2. The vacated areas should be consolidated and converted for covered storage use.

It will be necessary to extend the existing Port Administration Office building to accommodate the Port staff moved out of Warehouse #2 and other Port staff displaced from buildings identified for demolition within the new Commercial Cargo Terminal fence.

In the Near Term, if feasible, the Fishing Industry tenants in Warehouse #2 should be given preference for relocation to Warehouse #1 (subordinated to Port needs) adjacent to Fishing Boat operations at F-3. However, if there is insufficient space in Warehouse #1, they would have to find space elsewhere.

In the Long Term, as demand for space adjacent to the container terminal becomes more valuable the Long-liner Fishing Industry operations should be relocated to Hotel Wharf as designated under the current master plan. Note that the CASAMAR lease is a long-term lease and is not affected by the master plan except for the strip of land that is needed for access as described in Section 6.1.12.

E6.3 Cruise Vessels & Passenger Traffic

As described in Section 6.2, we recommend that in the Near Term the cruise passenger traffic and the long-liner Fishing Boat traffic share the F-3 Wharf and be segregated from Commercial Cargo Terminal operations.

Space needs to be provided for a covered arrival area, customs and immigration protocols for the cruise traffic. In the absence of space in Warehouse #1 this function would have to be housed in a new prefab building or trailer to be located near the gate providing access to Berth F-3 (See Figure 5.5-1). This need should be considered when renegotiating property from CASAMAR for the Berth F-3 access road. Sufficient area Southeast of Warehouse #1 should be provided to support Tour Bus turnaround and parking during cruise vessel calls.

In the Long Term if Cruise Calls increase to a sufficient volume to economically warrant dedicated facilities, the Port should locate such a facility within the areas under its control for supporting oceangoing deep draft vessel traffic at that time.

E6.4 Cement Unloading

The cement unloading demands during the base construction period will exceed the current capabilities in Guam for unloading this cargo.

Note, the type and extent and the type of new construction both for the military and support infrastructure in Guam is not readily known at this time. For example refurbishment of existing buildings for use as base housing would result in lower cement usage and use of concrete highway construction for infrastructure modernization would increase cement usage. Since these variables are not readily apparent at this time it would be prudent to ensure that there is a base plan to cover the low or likely forecast and also a contingency plan if demand is much higher than anticipated. Note that as contracts are awarded



for base construction and other infrastructure development projects the extent of cement demand will become more apparent.

Hanson Cement has indicated it is capable of increasing throughput up to 250,000 to 300,000 Tons/Year if their current unloading barge area dredge depth is increased. Additional dolphins, equipment and storage facilities would have to be put in place by Hanson. Under the low forecast scenario these facilities will be sufficient to address Guam's needs for cement during base and infrastructure development.

We recommend reviewing the feasibility of increasing dredge depth at the Hanson unloading dock. If feasible this work should be done during construction dredging of the commercial cargo wharf (F-5 to F-7). This would better assure that the dredging is done at a reasonable cost as part of the much larger wharf project. A suitable adjustment in lease terms to pay for this is reasonable if appropriate under the terms of the agreement. This could be in the form of future wharf revenue to the port. This should be addressed in conjunction with an assurance of upland and unloading facility improvements to support the cement demands.

Under the high volume forecast scenario it may be necessary to attract a new cement supplier who would be located at the Seaplane Ramp property, Golf Pier or further expansion of the Hanson facility for handling the additional cement cargo will be needed.

E6.5 Land Use & Zoning

The Existing land use environment around the Commercial Port area is described in Section 2.1.3. The current land use designations are presented in Figure E2.1-2, "Commercial Port & Vicinity Land Use Designations".

In addition to the recommendations described previously for addressing the Port's ongoing needs for the existing types of cargo the Consultant's assessment of the commercial port area showed certain additional deficiencies that should be addressed in order to support the long term waterborne transportation needs of the people of Guam. These deficiencies related to the availability of developable land immediately adjacent to deep navigable waters for oceangoing vessels for the movement of future cargo and waterborne transportation not supported by the existing terminals.

Our review showed that there is very little land available to the Port in Apra Harbor with access to deepwater, inland transportation links and minimal conflict with other critical uses that cannot be fulfilled elsewhere. We therefore recommend the following Land Use changes.

Figure E6.5-1 Recommended Land Use Change

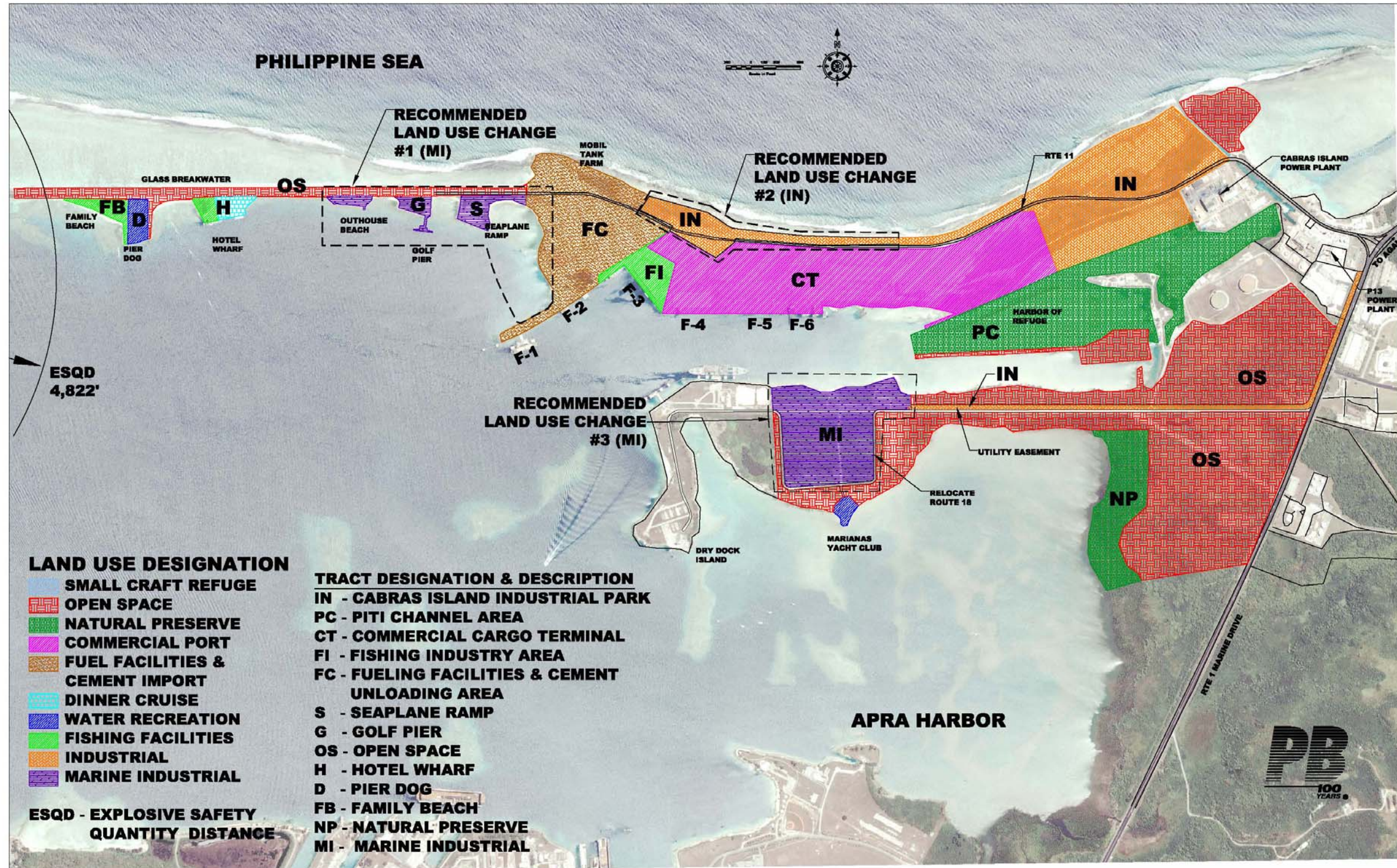

Marine Industrial Designation

We recommend that the proposed land use changes described below under “Land Use Change #1” and “Land Use Change #3” and shown on Figure E6.5-1 as designated for “Marine Industrial” use encompass any industrial or commercial facilities that are dependent for their operation on access to deep-draft oceangoing vessels with associated water borne transportation needs directly to or from their facilities.

Land Use Change #1

We recommend that the land use for the area highlighted “Recommended Land Use Change #1” in Figure E6.5-1 encompassing Outhouse Beach, Golf Pier and Seaplane Ramp be changed to “Marine Industrial” use.

The Consultants further recommend that additional land be created on an opportunistic basis within this Marine Industrial Zone in locations where it is feasible from an engineering and economic perspective. Figure 6.5-2 illustrates one conceptual approach proposed in PAG’s “Draft EIS for the Master Plan for Deep-Draft Wharf and Fill Improvement in Apra Harbor”. Other feasible configurations within the framework of Federal and Local Environmental regulations should also be considered.

Land Use Change #2

We recommend that the land use for the designated area highlighted “Recommended Land Use Change #2” in Figure E6.5-1 be changed from “Open Space” to “Industrial”. This sets aside a contiguous area within the Commercial Port with more flexibility for fulfilling the needs of the various terminals. Industrial use of land along this area should be performed in conjunction with sound coastal engineering protection practice in order to shelter the road and port areas from storm wave conditions.

Land Use Change #3

We recommend that the land use for the designated area highlighted “Recommended Land Use Change #3” in Figure E6.5-1 be changed from “Open Space” to “Marine Industrial” use. This change would relocate Route 18 to the south and around this zone in order to provide land adjacent to deep draft navigation in Cabras Channel. It is recommended that the alignment of Route 18 along the east boundary of the newly designated Marine Industrial area be located as shown including a buffer to the east of the new road in order to minimize the impact on existing wetlands along the eastern shoreline of this open space area. We also recommend setting aside a utility corridor adjacent to and north of Route 18 and West of Route 11 as shown to provide utility service to the newly designated area.

All other land uses in the vicinity of the commercial port would remain unchanged from the current designations adopted in 2000. The proposed activities to be permitted in the various areas are shown on Figure E6.5-1.

E6.6 Port Security

In addition to segregation of cargo related and non-cargo related operations, the consultants have recommended a number of security related considerations in Section 6.6 in order to meet modern Port Security protocols (ISPS/TPAT) as applicable.

E6.7 Marinas

The Port of Guam owns the three major public marinas and associated small boat harbors on the island of Guam. Together they provide opportunities for most of the public’s small boat needs. However the condition of these facilities does not allow the public to benefit fully from their amenities. To make the most use of the facilities, they must be in good condition and provide the services appropriate to their location and existing layouts. All three marinas should be considered as a whole when making decisions on maintenance and improvements.

General Operational Improvements

A number of major improvements are necessary at these marinas in order to bring these on par with similar modern amenities in the country. With this as the benchmark we recommend that the following general operational improvements be made at these marinas.

- Improve and maintain safety to contemporary modern codes and standards.
- Improve and maintain security control including gates, lighting, restrooms and patrols.
- Standardize utility services at the floats.
- Provide reliable sanitary sewage disposal facilities at each marina.
- Place the management of marinas under the control of one marina manager.
- Provide timely response to tenant requests and complaints and maintain a log of all issues that are addressed.
- Prioritize capital improvements.
- Develop and implement a standardized slip vacancy filling procedure.

General Marina Rates

Marina Rate Recommendations include:

- Implement the rates proposed in the amended Marina Rules and Regulations of the Port Authority of Guam as adopted by the Port Authority Board of Directors on March 19, 2004 with the exception that the marina rates for the Gregorio D. Perez Marina should be the same as those proposed for the Agat Marina. While the condition of the Gregorio D. Perez Marina is poorer than that of Agat, it has a better location (proximity to the main business district) and the current slip demand far outweighs the supply. The rate increase for the marinas should be concurrent with capital improvements discussed herein.
- Open Space storage fees should be increased.
- Re-evaluate and increase the rate structure for commercial vessels. Commercial vessel rates at Gregorio D. Perez Marina should not be less than recreational rates at Agat.
- Businesses that use marinas for tourist related or other activities should be charged additional fees consistent with traffic and usage.

The following specific recommendations are made for each marina and harbor.

E6.7.1 Gregorio D. Perez Marina

Gregorio D. Perez Marina is in the poorest condition of the three facilities. Safety repairs should be made immediately or the unsafe marina areas should be placed off limits to personnel until safety corrections are made. The estimated cost of replacing the marina in the same configuration is approximately as follows:

Estimated Capital Costs: \$3.5 Million.

While the safety repairs stated in the condition survey need to be accomplished, the long term goal of the facility should not be to merely repair the existing facility "as is". As part of this replacement the marina should be expanded and reconfigured with a different mix of slip lengths and fairway widths. The marina should be a magnet for recreational, charter, and local fishing boats. The marina should emphasize and support the local recreational, tourist and fishing economy. Current law states that the marina should emphasize recreational uses. The language should be re-evaluated and changed to emphasize recreational, tourism and fishing equally. All are important to the local citizens of Guam.

A realistic expansion would include increasing the size of the West Basin by excavating and expanding to the west toward the sewage treatment plant access road. Specific recommendations are provided in Section 6.7 for the expansion.

Estimated Capital Cost of Expanded Alternative: \$4.8 Million.

Gregorio D. Perez Marina has great potential, but it will also cost the most to realize that potential. The marina should be improved and/or expanded with the funding coming from increased slip lease rates. Depending on the final configuration, rental rates, cost of improvements, financing framework and the demand some form of funding or subsidies maybe necessary.

E6.7.2 Agat Marina

Recommended changes and improvements to this marina include the following:

- Replace existing slips at A dock with larger boat slips and floats that can accommodate larger and heavier boats.
- Remove sunken boats and chains attached to the breakwater.
- Improve security.
- Repair the refueling pier and boat ramp boarding piers.
- Dredge the marina, near D dock.
- Evaluate enclosing the boat basin by extending the existing breakwater around D dock and connect to shore. Water circulation within the marina must be taken into account and designed for. This is an expensive improvement and should only be undertaken if the marina occupancy increases above 80 percent.

The estimated cost of these improvements including extending the breakwater is estimated to be as follows:

Estimated Capital Cost: \$2.3 Million,

Due to the relatively good condition of the marina, the improvements could be prioritized and phased in over time.

E6.7.3 Harbor of Refuge

The primary goal for the Harbor of Refuge is to provide a reliable shelter for non-trailerable boats from typhoons and other significant storm events. To that end the main goal is to provide secure anchorages that will not fail in the event that they must be used for that purpose. All anchorages should be inspected and those with obvious or questionable deficiencies repaired or replaced. A bathymetric survey of the entrance channel and harbor should be made to verify that advertised depths can be achieved. Maintenance dredging should be performed as required. This must occur before other investments are made at this location.

This site should also be further evaluated for potential use as a location for an inspection, maintenance and repair facility. Located out of the main downtown district, this would allow activities that may not be consistent with tourist and recreational activities. There is a need on the island for a location to perform inspections and minor maintenance of boats. This location is preferred over the site currently being used at the Gregorio D. Perez Marina. A boat ramp can be installed at this location similar to what is currently in place at Gregorio D. Perez Marina. A user survey should also be performed to determine the demand for a boat haul-out facility. The haul-out facility could consist of a hydraulic trailer with mule or a mobile boat hoist. If the demand exists, both alternatives should be evaluated for feasibility.

Other areas of the harbor should continue to be leased out at appropriate market rates. Agreements should include sufficient language to hold lessees accountable to cleaning up their sites after their lease is terminated or expires so the Port does not have to cover these expenses.

E6.8 Terminal Facilities & Buildings

The Capital Budget Estimates includes funds to refurbish and expand the buildings that will become an integral part of the proposed port modernization program. Improvements related to Route 11 and the intersection between Route 1 and Route 11 are not included in our estimates but should be studied and addressed as part of the ongoing infrastructure development program.

E6.9 Utility Improvements

Further details on the recommended improvements for utilities are presented in Section 6.9

E6.10 Lease Agreements

We offer the following recommendations with respect to implementation of the Master Plan update as relates to lease agreements.

- PAG should work closely with existing tenants to mitigate the impacts of relocation due to the modernization program in order to accommodate future redevelopment.

- Location of tenant pipelines and utilities must be considered in any redevelopment plan.
- PAG should review existing leases without escalation clauses to ensure that the rent reflects current market rates.
- Zoning and land use designations suggested in the current master plan need to be updated to reflect future cargo handling requirements.
- The agreement with the developers of Hotel Wharf needs review and either enforcement or renegotiation.

Public Law 28-92 is an act dealing with the creation of a Recycling Enterprise Zone at the Jose D. Leon Guerrero Commercial Port. Our assessment showed that the most suitable location within port property for this facility would be Cabras Island Industrial Park. This would be consistent with the Land Use recommendations in this report.

In order to encourage development by the private sector it is recommended that when a tenant makes significant investments in facilities and equipment the Port has the authority to negotiate leases extending up to 20 years in duration in order to provide the tenant with sufficient time for depreciation and amortization of its investment in facilities and equipment. Development such as those discussed in Section E6.5 adjacent to deep navigable waters for the movement of future types of cargo and waterborne transportation, can especially benefit from this flexibility.

E6.11 Implementing Near Term Needs

The prime near term driver for modernization of the Port's commercial cargo terminal facilities is the imminent relocation of the military base to Guam. According to DOD's Latest Port Readiness Requirement we understand the latest construction commencement target is July 2010. The extent of the modernization requirements identified in this report and the timeframe available to effect improvements constitute a challenge.

We therefore recommend immediate commencement of various Program Elements that are needed to meet the constrained timeframe. While development of a detailed implementation plan is not part of the master plan scope of work, we offer the following outline of key tasks and activities that should be initiated forthwith in order to begin the modernization program:

- Perform a Financial Feasibility Analyses and Identification of potential Funding & Financing Options.
- Develop detailed alternative Implementation Plans consistent with the findings of the Financial Feasibility results.
- Begin the Site Characterization Work required for engineering and environmental design development.
- Initiate Environmental Analysis and the necessary Federal and/or Local Permitting Process related to typical port development.
- Perform Facility Design Sufficient for supporting the above activities.
- Consistent with Government and Port policy begin a concurrent process to identify potential private and public investment and funding partners.
- We anticipate that the award of a typical form of accelerated delivery method will be required in order to target the anticipated base construction schedule. The findings from the above tasks should be used as the basis for identifying the most appropriate alternative consistent with financial and schedule goals.
- Prepare documents and procure the various forms of contracts necessary to implement the modernization program and begin operations at the new modernized Port of Guam.

We estimate that the schedule for completion of port modernization in time for commencement of base construction is very challenging. Consolidation of appropriate activities may optimize the time frame. A program to initiate the above activities should be planned and put in place forthwith.



Section 1 Introduction & Background Conditions

1.1 Introduction

Guam is an incorporated territory of the United States. It is the largest island in the Marianas Archipelago in the Pacific Ocean, located 3,810 miles west of Honolulu, 1,560 miles from Tokyo and 1,700 miles from Taipei. Its population is currently some 173,000 comprising mostly civilians but also military personnel and their dependents from the U.S. military bases located on the island. It is governed by the Government of Guam represented by the Governor and the Guam Legislature.

The enabling act of the Jose D. Leon Guerrero Commercial Port or Port Authority of Guam (the Port or PAG) calls for the Port to provide for the needs of ocean commerce, shipping, recreational and commercial boating and navigation of the territory of Guam. The Port Authority of Guam performs a crucial and indispensable role in the lives of the civilian and military population of Guam, the military bases and neighboring islands in the north-pacific region. Some 90% of the day to day goods and supplies consumed by its constituencies pass through the Port. In addition it is the primary seaport in Micronesia and serves as a transshipment hub for the entire Western Pacific Region. Shipping lines depend on the Port to provide direct service to Asia and Micronesia.

The commercial port, was designed and put into service in 1969, and has not undergone a major modernization program since that time. An upcoming military base move from Okinawa to Guam is estimated to increase Guam's population by some 22% by the year 2014. This coupled with the demands for cargo movement during base construction, is expected to put considerable demands on the Port in the coming years. Accordingly PAG is vested with the responsibility of overseeing the development of assets and the implementation of policies and strategies to facilitate a smooth transition to the new population base, support diversification of Guam's economy and position Guam to participate in the growth in seaborne international trade that is expected to occur in the new millennium.

On August 7, 2007, the Port Authority of Guam commissioned PB International, Inc. (The Consultant) to update its Master Plan to include an Impact Assessment on the Port Authority of Guam Facilities due to relocation of Okinawa-based Military personnel and related ancillary activities and major developments affecting Guam. The Consultant's detailed Scope of Work for execution of this assignment is presented in Appendix 1-1.

This report describes the Consultant's activities, analysis and findings on the Master Plan Update for the Port Authority of Guam.

1.2 Socio-Economic Trends & Forecasts

The consultant team reviewed the Socio-Economic trends in Guam in order to understand the impacts on the commercial port. Demand for port facilities and services is a derived demand, meaning that it is driven by economic activity. The primary economic sectors on Guam are tourism and the Department of Defense (DOD). In addition, cargo activity is also driven by the local population base, construction (supporting both civilian and military) and transshipment to neighboring islands. The following section includes an assessment of recent trends and expected future level of activities that drive port activity levels.

1.2.1 Population Trends & Forecasts

The population trends on Guam are described in this section.

1.2.1.1 Civilian Population

The Consultant team reviewed population information for Guam from the Government of Guam Bureau of Statistics, US Department of Defense and the US Census Bureau.

Guam's population stood at 173,456 persons in 2007. The population has grown at an annual rate of 1.6 percent per year since 1988. The population grew relatively fast between 1988 and 1992 (2.8 percent per year) then slowed through 1998 (0.8 percent per year). The growth rate during the past seven years (2000 to 2007) mirrors the rate from 1988 to the present (at 1.6 percent per year). The US Census Bureau expects slower growth in the future; averaging 1.3 percent per year until 2015 then slowing to 0.9 percent for the longer term (after 2015). In 2018, the civilian population on Guam is expected to approach 182,000 persons.

Figure 1.2-1 Guam Civilian Population Trends & Forecasts

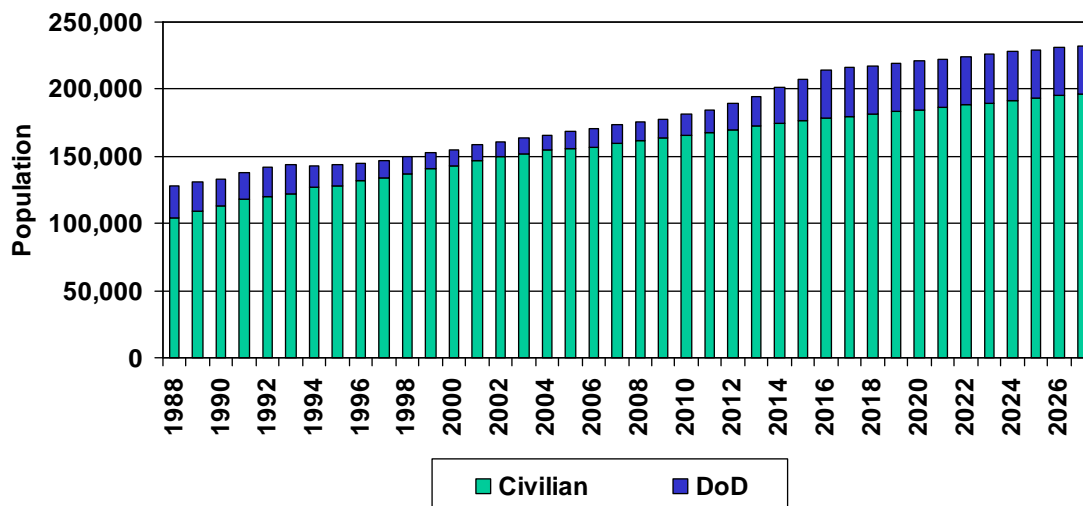

The largest ethnic group on Guam is identified in official classifications as the indigenous Chamorro people, who account for about 37% of the population. The next largest group consists of Filipinos, representing 26% of the population. Caucasians comprise about 7%, and the remainder includes a variety of ethnic groups (Koreans, Japanese, Chinese, and other Pacific Islanders).

1.2.1.2 Military Population

Based on information provided by DOD, Guam's military population (including active duty personnel and their dependents) stood at approximately 14,110 persons in 2007. This includes 6,420 active duty personnel (4,350 in the US Navy, 1,930 in the US Air Force, and 140 in the US Coast Guard) and 7,690 dependents (5,230 with the US Navy, 2,280 with the US Air Force, and 140 with the US Coast Guard). See Figure 1.2-2.



Figure 1.2-2 Current Force Levels on Guam (2007)

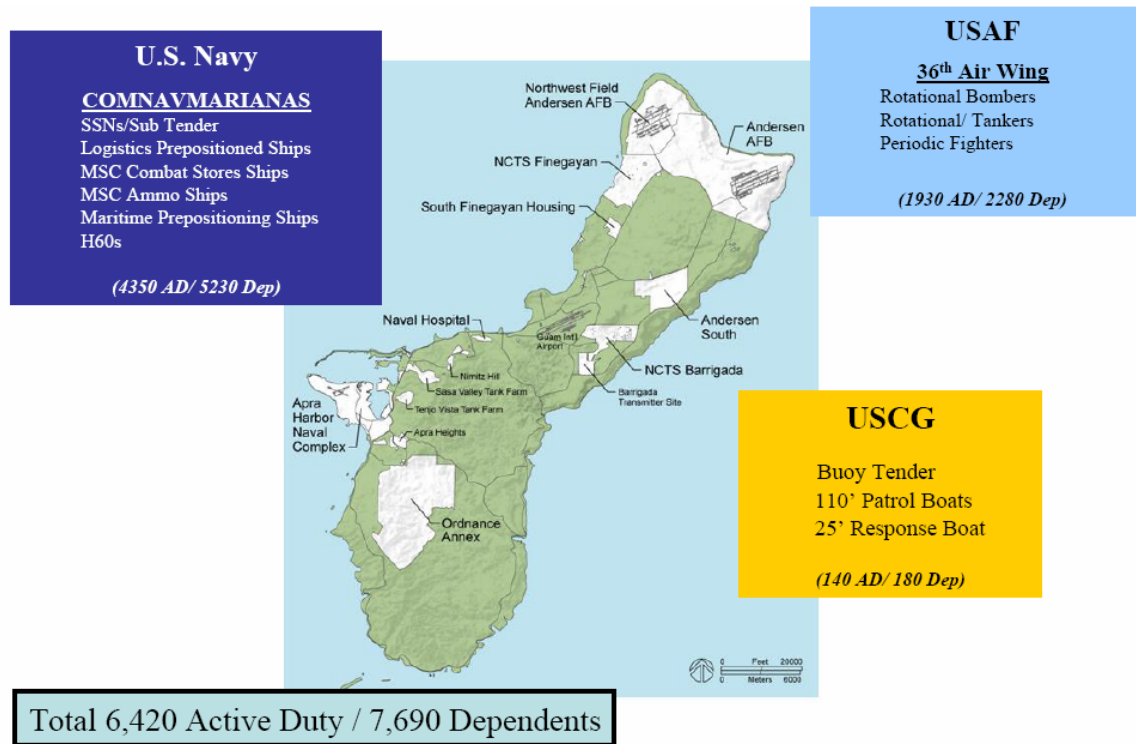

Source: DOD

The DOD is projecting a future deployment on Guam of 38,070 active duty and dependents. As shown in Figure 1.2-3, this includes 18,930 active duty personnel (5,600 in the US Navy, 4,560 in the US Air Force, 10,000 in the US Marines, 630 in the US Army and 140 in the US Coast Guard) and 19,140 dependents (5,280 with the US Navy, 3,730 with the US Air Force, 9,000 with the US Marines, 950 with the US Army and 180 with the US Coast Guard). This represents an increase of 23,960 persons over current levels, including 12,510 active duty personnel and 11,450 dependents.



Figure 1.2-3 Future Force Levels on Guam (phased in by 2016)

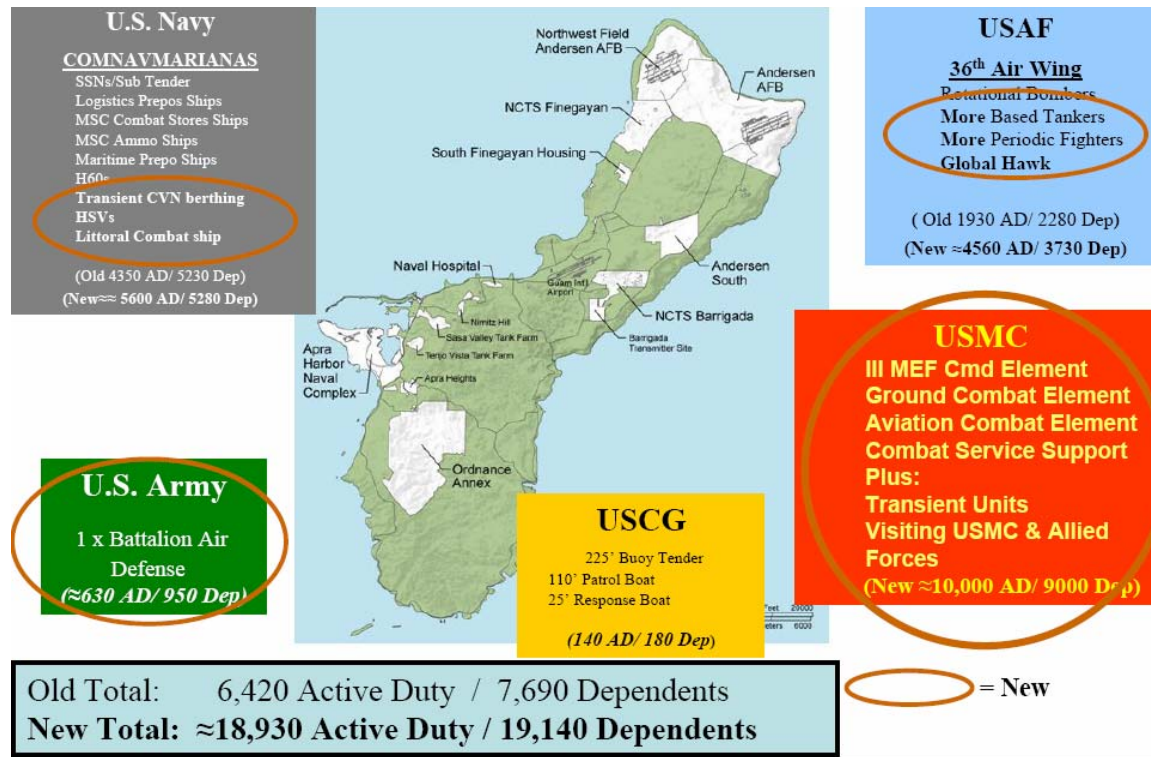

Source: DOD

In the late 1980s, the military population exceeded 20,000 in Guam and represented approximately 18 percent of the civilian population. The military presence shrank to around 11,000 in the period 2000 to 2004 before increasing to its current level of 14,110, which equals 8.1 percent of the civilian population. The proposed growth in military personnel and dependents will increase the military presence to around 18 percent of the civilian population base.

1.2.1.3 Total Population

The total population on Guam increased from 127,545 persons in 1988 to 173,456 persons in 2007, with average annual growth at 1.6 percent. The population is expected to reach around 232,000 in 2027 with annual growth averaging 1.5 percent. See Table 1.2-1.



Table 1.2-1 Population Trends & Forecasts

Year	Civilian Population		Military & Dependents		Total Population		Mil PERCENT of Civ Pop	
	Actual	Forecast	Actual	Forecast	Actual	Forecast	Actual	Forecast
1988	104,330		23,215		127,545		18.2%	
1989	109,295		21,652		130,947		16.5%	
1990	113,542		19,610		133,152		14.7%	
1991	118,082		20,077		138,159		14.5%	
1992	120,148		22,178		142,326		15.6%	
1993	121,748		22,077		143,825		15.3%	
1994	127,292		15,865		143,157		11.1%	
1995	128,430		15,760		144,190		10.9%	
1996	131,532		13,792		145,324		9.5%	
1997	133,797		13,002		146,799		8.9%	
1998	136,985		12,739		149,724		8.5%	
1999	140,431		12,159		152,590		8.0%	
2000	143,181		11,624		154,805		7.5%	
2001	147,177		11,153		158,330		7.0%	
2002	149,810		11,247		161,057		7.0%	
2003	151,761		11,832		163,593		7.2%	
2004	154,331		11,759		166,090		7.1%	
2005	155,863		12,701		168,564		7.5%	
2006	156,909		14,110		171,019		8.3%	
2007	159,346		14,110		173,456		8.1%	
2008		161,414		14,110		175,524		8.0%
2009		163,508		14,110		177,618		7.9%
2010		165,630		15,439		181,069		8.5%
2011		167,779		16,768		184,547		9.1%
2012		169,956		19,425		189,382		10.3%
2013		172,162		22,083		194,245		11.4%
2014		174,396		26,513		200,908		13.2%
2015		176,659		30,942		207,601		14.9%
2016		178,249		36,257		214,506		16.9%
2017		179,853		36,257		216,111		16.8%
2018		181,472		36,257		217,729		16.7%
2019		183,105		36,257		219,362		16.5%
2020		184,753		36,257		221,010		16.4%
2021		186,416		36,257		222,673		16.3%
2022		188,094		36,257		224,351		16.2%
2023		189,786		36,257		226,044		16.0%
2024		191,494		36,257		227,752		15.9%
2025		193,218		36,257		229,475		15.8%
2026		194,957		36,257		231,214		15.7%
2027		195,975		36,257		232,233		15.6%
Compound Annual Growth Rates								
1988-2007	2.3%		-2.6%		1.6%			
2000-2007	1.5%		2.8%		1.6%			
2008-2027		1.0%		5.1%		1.5%		

Source: Government of Guam Bureau of Statistics, US Department of Defense, US Census Bureau



1.2.2 Economic Trends

The economy of Guam is described in this section.

1.2.2.1 Overall Economic Activity

The civilian economy generated approximately \$4.6 billion in sales in 2002, according to the most recent census. Local residents accounted for 38.8% of sales followed by visiting tourists (27.5%), businesses and non-military government agencies (17.5%), retailers/wholesalers (12.3%) and construction firms (3.7%).

Table 1.2-2 Sales by Class of Customer (\$1,000s) in 2002

Source	Sales (\$1,000S)	Percent
Local residents	1,781,629	38.8%
Visiting tourists	1,262,753	27.5%
Retailers or wholesalers	564,795	12.3%
Institutional, industrial, commercial, professional, government, and farm users	803,570	17.5%
Construction firms	169,898	3.7%
Other	9,184	0.2%
Total	4,591,828	100.0%

Source: Census 2002 for Guam, US Census Bureau

In 2002, the military spent \$532 million in Guam, including \$282 million on construction projects and \$250 million on payroll (\$194 million for military personnel and \$56 million on civilian personnel). Military expenditures, which are not included in the Census estimates, amounted to 11.6% of sales in the civilian economy.

1.2.2.2 Trade Statistics

According to statistics from the Government of Guam, imports have increased from \$503 million in 2004 to \$583 million in 2007. This data includes items intended for resale in Guam and excludes the military, government, promotional and personal items. It also excludes imports of petroleum products. Most of Guam's imports consist of consumer goods (particularly food, beverages and apparel), motor vehicles and parts and construction materials.

Table 1.2-3 Guam Import Data (Current Dollars)

Group	2004	2005	2007	% 2007
Food and Non-Alcoholic Beverages	\$210,887,031	\$163,587,900	\$189,848,060	33%
Alcoholic Beverages	\$20,445,918	\$22,752,348	\$18,916,221	3%
Transportation and Parts	\$82,110,117	\$111,165,444	\$130,698,026	22%
Home Appliances, Equipment and Others	\$11,731,590	\$9,413,220	\$10,355,204	2%
Construction Materials	\$28,334,139	\$19,734,012	\$30,347,915	5%
Men's and Women's Apparel	\$32,188,479	\$26,132,346	\$81,147,705	14%
Plastics, Leather and Paper	\$48,733,398	\$93,249,228	\$34,736,713	6%
Other Imports	\$68,952,768	\$86,652,573	\$87,495,925	15%
Grand Total	\$503,383,440	\$532,687,071	\$583,545,769	100%

Source: Government of Guam, Bureau of Statistics and Plans

Note: 2006 data are not available. Also major fluctuations in Men's and women's apparel Plastics, Leather and plastics were discussed but corroboration was not available.

Guam exports totaled \$53.0 million in 2006 and will reach an estimated \$63.2 million in 2007. Exports (with the same caveats on excluded products as for imports) primarily consist of transportation products

and food and beverages produced in Guam and/or trans-shipped from Guam to the US and foreign countries.

1.2.3 Employment Trends & Forecasts

1.2.3.1 Overall Employment Trends

The civilian employment base in Guam was 58,700 in 2006. This was up slightly from the prior years. However, it is significantly lower than the employment levels of the mid to late 1990s, when employment averaged around 65,000 persons.

Figure 1.2-4 Civilian & Military Employment Trends in Guam (number of employees)

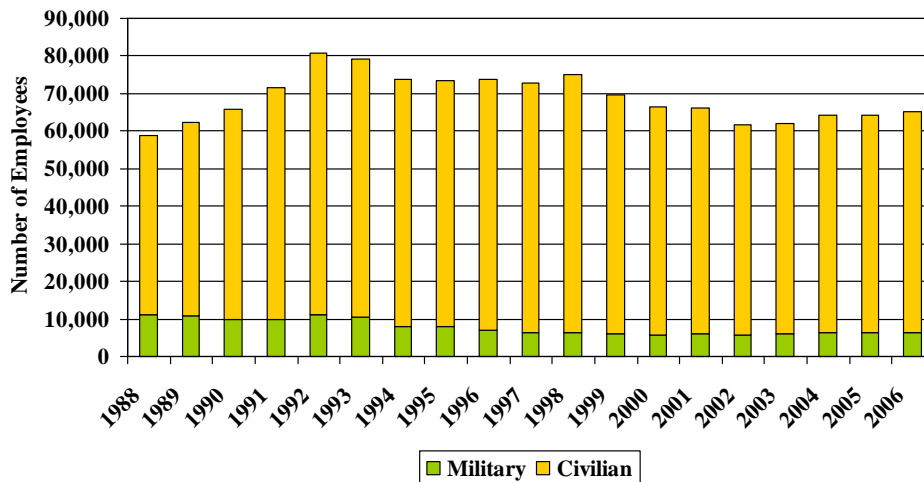

As reported earlier, there are currently 6,420 active duty personnel, which is equal to around 11 percent of the civilian employment base. Including civilian and military employees, there were 65,159 employed persons in Guam in 2006, down from a peak of 80,809 employed persons in 1992.

Like much of the rest of the U.S., Guam's employment base has become more oriented toward retail trade and services (including accommodations and business services). Between 1990 and 2000, retail grew at 1.4 percent per year, services at 2.9 percent per year and transportation at 2.1 percent per year. During this time period, there was a loss of jobs in construction, federal government agencies (non-DOD) and to a lesser extent in manufacturing.

Figure 1.2-5 Employment Trends

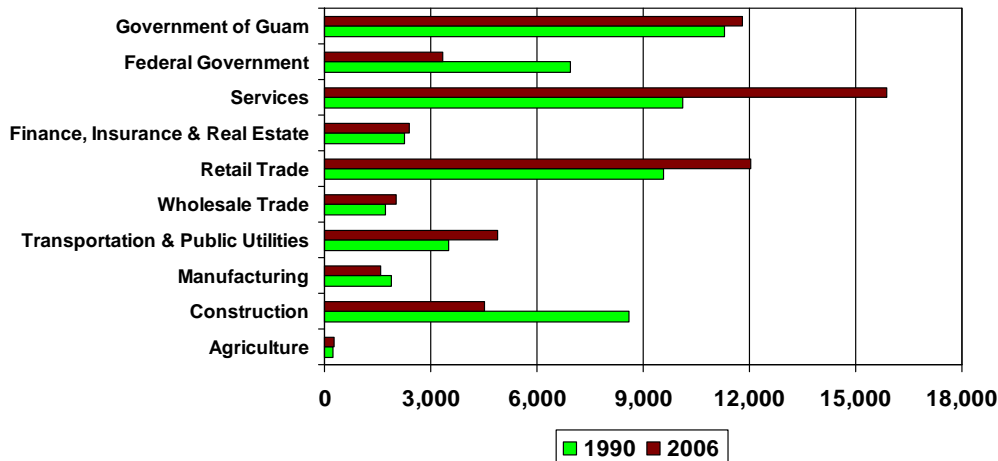

1.2.3.2 Tourism

Tourism is a very important part of Guam's economy. As noted above, the 2002 Economic Census indicates tourists accounted for 27.5% of non-military economic activity (business sales) in Guam. A recent economic impact study¹ indicates that tourism generates 15,200 jobs², \$378 million in income, and \$1.1 billion in direct expenditures.

Visitor arrivals grew rather steadily from 1988 through 1997 with only a few bumps in the road (Gulf War, Typhoon Omar in '92, earthquake in '93). Growth during this period averaged 9.5 percent annually. Since then, tourist arrivals have been much more volatile due to natural disasters (typhoons in '97 and '02; tsunami in '04); economic downturn in Asia ('97), SARS ('03/'04) and 9/11 ('01) and the Gulf War (began '03) among other exogenous impacts.

The Guam Visitor's Bureau is projecting growth in tourism ranging from 3% (nominal forecast) to 7% (aggressive forecast). This would bring arrivals from 1.4 million (nominal forecast) to around 1.7 million (aggressive forecast). See Figure 1.2-6.

The prospects for continued growth in tourism are favorable. According to the United Nations, tourism grew 4.1% worldwide led by Asia/Pacific Asia. The Pacific Region, which includes Guam, was able to maintain its extraordinary growth level with an increase of 7.6 percent over the previous year. This growth was due to the recovery of Thailand and the Maldives from the impact of the December 2004 tsunami, as well as remarkable performances from emerging destinations in the region (i.e., international tourist arrivals in South Asia grew by 10%).

The United Nations forecasts that "The increase in international tourist arrivals is projected to be around 4% through 2020³". Growth is expected to be more solid as businesses, consumers, governments and international institutions such as the UNWTO are now better able to anticipate shocks and to respond more effectively to crises.

¹ Source: Guam Tourism Economic Impact, prepared by Global Insights for the Guam Visitors Bureau, May 2007.

² Including direct, indirect and induced impacts.

³ Source: Tourism 2020 Vision, World Tourism Organization.

Figure 1.2-6 Guam Visitor Trends & Forecasts

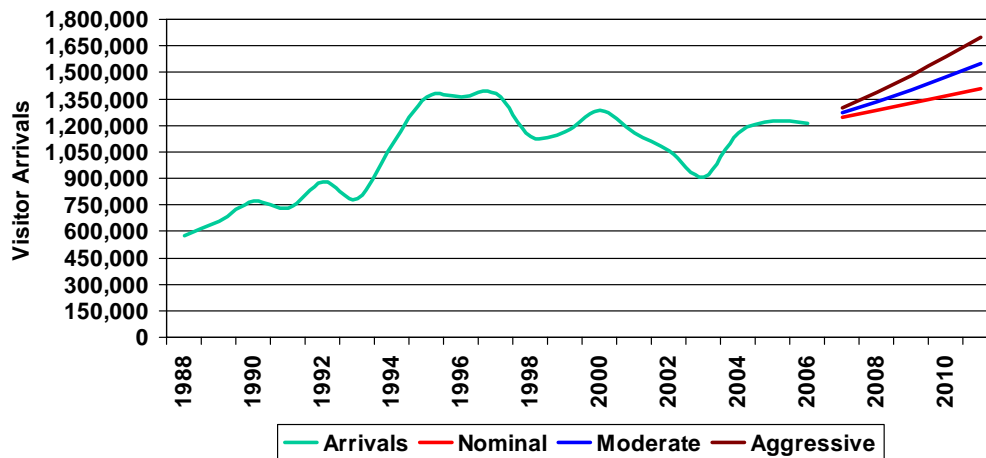

There have been and are expected to continue to be exogenous factors that impact the future development of the tourism industry on Guam. The tourism industry of Guam faces tough competition from other regional and global destinations. In addition, its core market of Japanese consumers is very mature. Reports⁴ have indicated that the aging of the Japanese population will act to constrain tourism. As a result, the Guam tourism industry is looking to other countries for growth. The visitor target mix for 2011 includes the following expected shifts in the visitor market on Guam:

- Visitors from Japan decline from 80% to 68% of total visitors,
- Visitors from Korea increase from 10% to 19% of total visitors,
- Visitors from USA/Hawaii increase from 4% to 5% of total visitors, and
- Visitors from East Asia increase from 4% to 6% of total visitors.

The Chinese market may represent a large potential pool of customers.

The Guam Visitor's Bureau estimates that the "island's capacity is 1.7 million tourists, based on the existing visitor patterns and durations of visit". As this capacity is approached additional assets for the tourist industry will be needed, including improvements/additions to hotel rooms: the Airport, the Sea Port, public transportation, car rentals, wedding chapels, golf courses, among other assets. However, the Guam Tourism industry recognizes the need to address the problem of an aging stock of tourism infrastructure, particularly hotel rooms and facilities, which is partially responsible for the loss in both quantity and quality of visitor flows.

1.2.3.3 Construction Industry

Construction activity has averaged around \$250 million in sales in the past three years. During the past 30 years, construction spending reached a peak of one billion dollars in 1992 (in \$2006).

The DOD is projecting that between FY2007 and FY2015, construction spending for military projects would total approximately \$12.5 billion, with more than \$10 billion from the relocation of the Marine Base. The plan is to begin construction in 2010 with a goal to complete construction by 2014. Construction would average approximately \$2.7 billion per year between FY2010 and FY2013. These estimates are based on projected award amounts, which were distributed across the fiscal years using reasonable assumptions for construction workload distribution. However, it must be emphasized that these construction cost estimates are preliminary and should be refined as more data becomes available.

⁴ Source: Impact of Population Aging on Japanese International Travel to 2025, by James Mak, Lonny Carlile, and Sally Dai for the East-West Center, October 2004



Table 1.2-4 DOD Projected Construction Expenditures

Source	FY07	FY08	FY09	FY10	FY11	FY12	FY13	FY14	FY15	Total
Army							75.0	75.0		150.0
Navy	58.4	55.4	56.4	68.0	68.0	68.0	68.0	68.0	68.0	578.2
Medical	0.0	0.0	21.7	47.7	49.5	0.0	0.0	0.0	0.0	118.8
Air Force	204.0	244.8	328.1	214.2	204.0	100.0	100.0	100.0	100.0	1,591.2
Marines	0.0	68.0	68.0	2,038.0	2,620.0	2,670.0	2,574.0	232.0	0.0	10,270.0
Total	262.4	368.2	474.1	2,367.9	2,941.5	2,838.0	2,742.0	400.0	168.0	12,562.1

Source: US DOD

In addition, there are substantial projects required of the Government of Guam, including:

- DPW Roads and Highways: \$1.575 Billion
- GPA: \$660 million
- GWA: \$487 million
- DPW Solid Waste: \$230 million

The Government of Guam could spend \$3.0 Billion to be invested on Guam's growth over the next decade or around \$300 million per year.

In addition, private construction spending has averaged around \$153 million per year during the recent past.

Construction activity on Guam from all sources could exceed \$3 billion per year for the period FY2010 through FY2013. This level of expenditure is three times the peak activity on Guam (experienced in 1992). If the construction program is delayed by a year by legal or programmatic problems, it is likely that the completion date may also be delayed. An alternative forecast is provided in Figure 1.2-7, which entails a delayed commencement combined with more construction activity in 2014 and 2015.

This level of activity (under either alternative) represents a good economic opportunity for Guam but will require a coordinated response.

Figure 1.2-7 Construction Activity on Guam (Sales in \$1,000s of 2007\$)

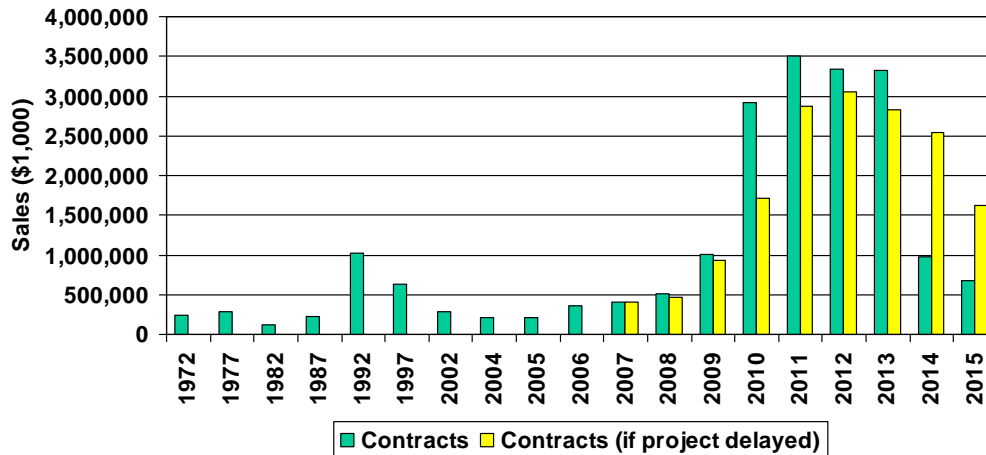

Construction employment has averaged around 4,800 workers during the past three years. It reached a peak of 12,500 workers in 1992. Between 2010 and 2013, it could average around 27,000 workers. This could require approximately 19,000 workers from off island (assumes that 8,000 workers are from Guam). Under the alternative construction program, there would be a slight decrease in annual construction workers, with around 22,000 during the period 2010-2013 (with around 14,000 from off island). If efforts are undertaken to improve productivity, then fewer employees from off-Island would be required.

Figure 1.2-8 Construction Employment on Guam

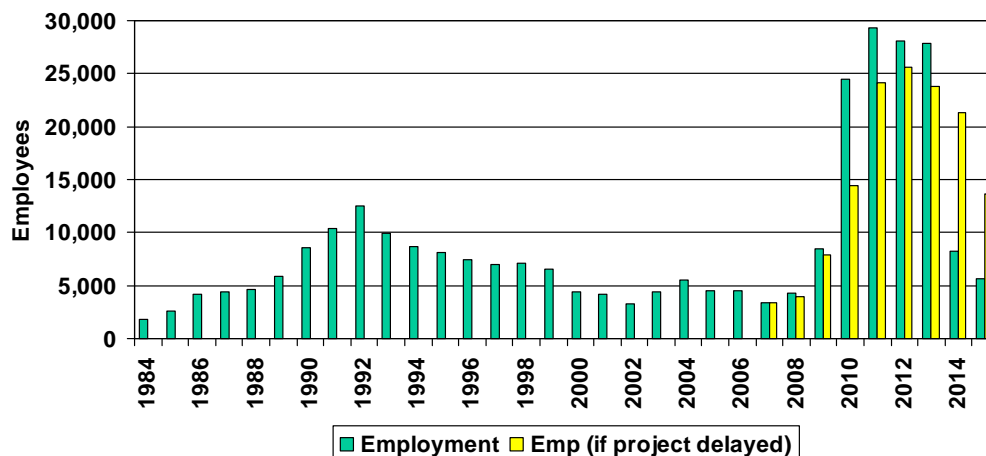

1.2.3.4 Fisheries

Since the focus of the master plan update was the potential for substantial increases in commercial cargo a detailed analysis and assessment of fisheries trends and projections is not included in this report. The review described below was performed for the purpose of assessing fisheries impact on commercial cargo movements. Trans-shipment of tuna through Guam has declined as the fishery moved to more distant grounds and due to changing fishing regulations. However, trans-shipment of tuna continues to play a major role in Guam. Tuna is primarily moved from Guam to Asian markets by both air and sea services.

The decline in trans-shipment volumes after 2001 was largely a response to the Shark Finning Act of 2000, which prevented vessels from trans-shipping through Guam if their country was engaged in shark finning. As a result of this US law, the Taiwanese fleet moved into the Indian Ocean. The Patriot Act and Maritime Transportation Security Act of 2002 (MTSA) have also impacted trans-shipment activity through Guam by increasing the costs to the fleet serving Guam, which is the most highly regulated port in the area.

Despite these constraints, Guam has a relative advantage for trans-shipment because of its location relative to the harvest areas, political stability, expansion of the market for tuna (especially in China) and its infrastructure (port, airport, fish processing and like facilities and services).

Figure 1.2-9 Tuna Trans-shipments via Guam

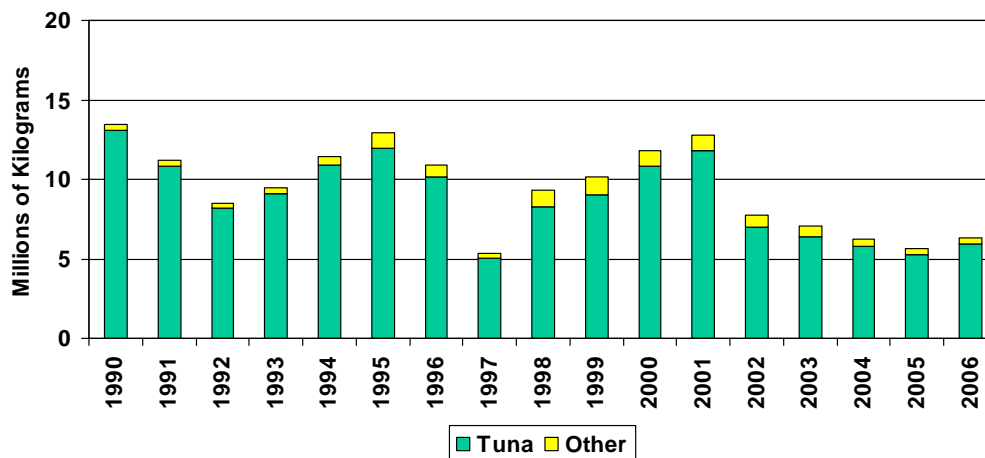

1.2.3.5 Trans-shipment Markets

Virtually all cargo arrives by water to Guam and neighboring islands. Guam has the largest population base in this region and the most cargo, and hence, is a natural trans-shipment hub to the neighboring islands.

North of Guam lays the Commonwealth of the Northern Mariana Islands (CNMI), including Saipan, Tinian and Rota, among other smaller islands. The containerized and break-bulk cargo to/from the CNMI has long been moved via Guam by trans-shipment services. However, the CNMI is experiencing a declining base of cargo due to the loss of garment manufacturing base and a general decline in tourism. Tinian could experience military buildup of approximately 2,000 active duty military. Some of these cargo needs could be served from Guam or service could be direct or via Saipan. Saipan could serve as a staging base for construction in Guam. However, the trade-off centers on the capacity of Guam to handle the cargo flows associated with projected construction activity as compared with the additional costs due to double handling, if the construction materials and/or modular construction were handled in the CNMI. Contractors in Guam have stated that the most cost effective construction process would be to cast in place rather than import modular tilt-up buildings.

Most of the trans-shipment is via Guam to the Federated States of Micronesia, Republic of Palau and the Republic of the Marshall Islands. Hawaii was previously the origin of transshipment to the Eastern Caroline Islands (Marshall Islands and Kosrae, Pohnpei and Chuuk in the FSM) but this recently switched to Guam. Details on trans-shipment services are contained in the next section. The population base in these trans-shipment areas could increase at approximately 0.9% year between 2007 and 2025. This is down from the annual growth of 1.5 percent experienced between 1995 and 2007.

It should be noted that trans-shipment is very cost sensitive in most areas. The Port of Guam has worked with the carriers engaged in this trade to set rates conducive to attracting and retaining trans-shipment activity.

Table 1.2-5 Population Trends & Forecasts at Neighboring Islands

Population	1995	2007	2025	Growth Rates	
				95-07	07-25
CNMI	57,229	84,546	116,270	3.3%	1.8%
Rep of Palau	17,037	20,842	24,320	1.7%	0.9%
Rep of Marshall Islands	49,639	61,815	83,203	1.8%	1.7%
Fed States of Micronesia	105,988	107,862	98,879	0.1%	-0.5%
Total	229,893	275,065	322,672	1.5%	0.9%

Source: United Nations

Figure 1.3-1 Port Property Location Map

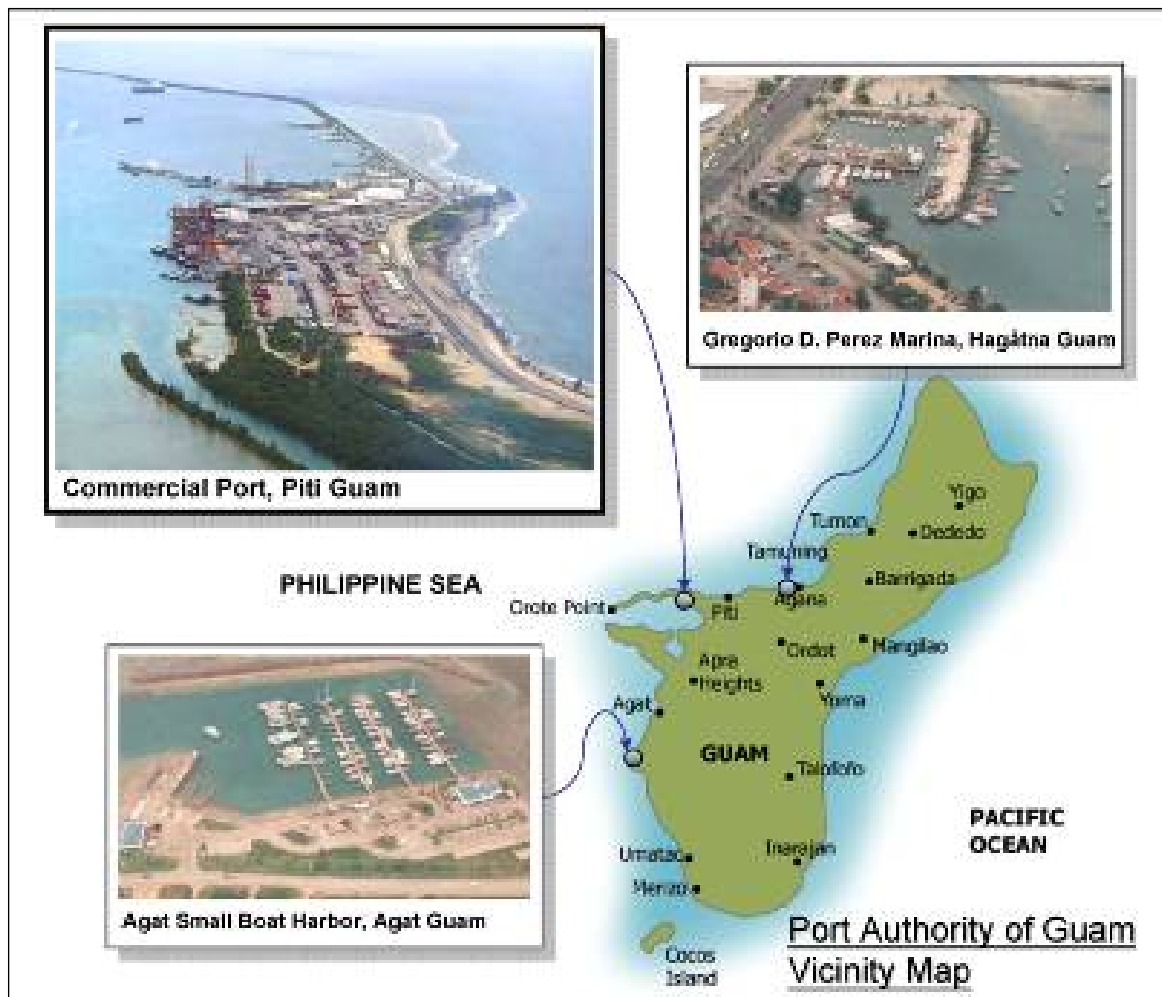



1.3 Port & Shipping Overview

The Jose D. Leon Guerrero Commercial Port of Guam is a deep water port, sheltered within the inner reaches of the Outer Apra Harbor. It offers facilities and services to ships of all registries.

Historically, Guam has served as a port of call since the 16th century, first catering to the ships of Spain and then, after the Spanish-American War, to American interests. Today, the Port is an important transportation hub linking the Commonwealth of the Northern Mariana Islands and Micronesian islands with the expanding Far East market, the United States and the rest of the world.

PAG is a public corporation and an autonomous agency of the Government of Guam. Its management is responsible for the planning, promotion, development, construction, operation, and maintenance of port facilities depicted in Figure 1.3-1.

In developing an updated Master Plan for the Port, the Consultants executed extensive stakeholder consultations and data collection. These stakeholder meetings took place between 8/10/07 and 12/12/07 as illustrated in Figure 1.4-1.

1.4 Overview of Stakeholder Consultations

The project was kicked off on August 7, 2007 starting with meetings with the PAG management and staff. Over a four month period the Consultant Team interviewed and met with numerous individuals and Port Stakeholders. A partial list of meetings conducted by the team is presented in Figure 1.4-1 on the next page. Meeting notes on these and other meetings are presented in Appendix 1-2.

1.5 Overview of Data Collection Process

The Consultant prepared a Questionnaire outlining the type of information that it was seeking in order to assist in the data collection process. This questionnaire was also used on a selective basis to solicit information and data from the various participants in the above referenced meetings.



Figure 1.4-1 List of Meetings

	Company, Organization or Individual	Meeting Date
1	Ambyth Shipping & Trading Co., Inc.	08/10/07
2	Casamar Guam, Inc.	08/10/07
3	Marianas Steamship Agencies, Inc.	08/08/07
4	PAG Operations Staff	08/08/07
5	Military Surface Deployment and Distribution Command (SDDC)	08/10/07
6	Bureau of Statistics and Plans & Coastal Zone Management	08/08/07
7	Department of Labor	08/08/07
8	Guam Economic Development and Commerce Authority (GEDCA)	08/07/07
9	Horizon Lines	08/08/07
10	Matson Navigation Company	08/08/07
11	PAG Finance Department	08/10/07
12	Seabridge, Inc. & Cabras Marine	08/08/07
13	Director of Department of Public Works (DPW)	08/09/07
14	Guam Power Authority & Guam Water Authority	08/09/07
15	PAG Maintenance Department	08/10/07
16	Parks & Recreation Department / Historical Preservation Division	08/31/07
17	Oceaneer Enterprises, Inc.	08/10/07
18	Marianas Express Lines / CTSI Logistics	08/08/07
19	Port of Guam Commercial Facilities Field Tour	08/07/07
20	Shell Oil	08/09/07
21	Maritime Affairs Committee	08/09/07
22	U.S. Coast Guard	08/27/07
23	Marina Fishing Boat Users	08/29/07
24	U.S. Coast Guard	08/27/07
25	PAG Security	08/27/07
26	Watts Constructors	09/09/07
27	Guam Visitors Bureau	09/12/07
28	Guam Power Authority	09/09/07
29	Black Construction	09/12/07
30	PAG Operations	09/12/07
31	PAG Equipment Maintenance Staff	09/12/07
32	PAG Lease Review	09/12/07
33	Horizon Lines	09/14/07
34	Fishermen's Cooperative & Long-liner Tenants	09/12/07
35	Harbormaster	09/12/07
36	Two Day Port Development Conference	09/13-14/2007
37	Guam Development ICA Meetings, Washington D.C.	11/19/07

Section 2 Existing Port Environment

2.1 Commercial Port Access & Lands

2.1.1 Highway Access

The Commercial Port facilities owned and managed by the Port Authority of Guam are located along the Northern shoreline of Apra Harbor close to Piti. Access from Tamuning and other urban areas is via the four lane main arterial, Route 1, or Marine Corps Drive which at this point runs Southwesterly towards Piti. Access to the Commercial Port from Piti is via the two lane road Route 11. The intersection of Route 1 and Route 11 is signaled. From the intersection Route 11 runs west and crosses the Piti Channel Bridge onto Cabras Island. It is the only road access to Cabras Island. On Cabras Island Route 11 runs past Guam Power Authority's (GPA) Power Plant Complex adjacent to and to the South of the road, past vacant lands set aside for the Cabras Industrial Park and into the Commercial Port Area.

The Jose D. Leon Guerrero Commercial Port or the "Commercial Port" owned and managed by the Port Authority of Guam is located as shown in Figures 2.1-1 & 2.3-1 South of the access road. The North barrier along the road consists of a low seawall and armored



breakwater protection facing the Philippine Sea. A guard station is located at the entrance to the Commercial Port Area. The road runs past the Cargo Terminal and Marine Industrial Facilities Area and dead ends on Glass Breakwater, which forms the northern breakwater for Outer Apra Harbor.

2.1.2 Port Vicinity Road #11

Description & Metrics

Route 11 is a two lane road with 12-ft. travel lanes with 8-ft. wide shoulder (two ways) along the 100-ft. wide right-of-way corridor, and turning pockets at the entrance to the parking lot of the Port Administration Building and to the entrance of Container Yard (See Figure 2.3-2).

The pavement of traffic lanes of Route 11 is built with 8 in. thick base course and 2 in. thick asphalt with typical 2% drain slope outward; double bituminous surface treatment for shoulders with typical 5% drain slope outward. The traffic flow at interchange Route 1/11 is controlled by a traffic light complete with a left turn signal for traffic outbound from the Commercial Port Area.



Figure 2.1-1 Commercial Port Location & Access



Figure 2.1-2 Commercial Port & Vicinity Land Use Designations

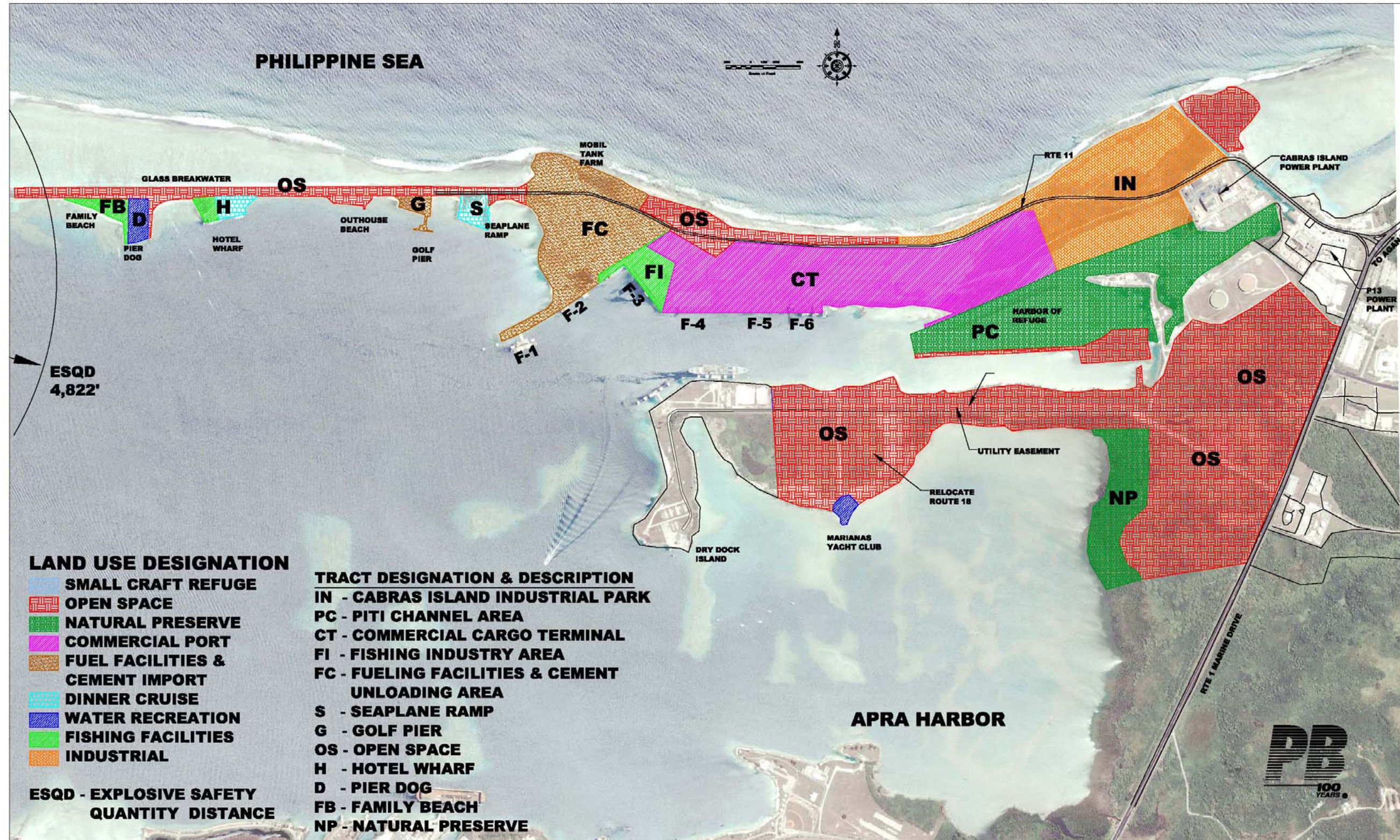



Condition Survey

According to the analysis revealed in the Guam 2010/2020 Highway Master Plan (by Department of Public Works, DPW), the traffic flow quantity will be still adequate up to 2020. No short-term or long-term improvements have been recommended. However, the Plan did not consider the volumes which would be produced by the proposed military build-up. A request to DPW to revisit the Highway Master Plan in light of the military build-up was submitted by PAG.

Maintenance and Operational Improvements

The above referenced study by DPW revealed a large amount of rocks/coral rubble piled up in front of the existing seawall. Such a situation allows increased wave run-up and renders the seawall ineffective against overtopping during large storms/typhoons. Overtopping of the seawall causes rocks/coral rubble to be deposited on Route #11, resulting in road damage and possible road closure, and flooding of the Cargo Terminal yard. We understand that remedial options were studied for protecting Route #11 from wave overtopping by the U.S. Army Corps of Engineers (USACE) and that the option chosen for implementation would "Remove rocks & rubble and construct a Single or Double Layer Revetment". This study effort is currently in progress.

2.1.3 Land Use Environment

The current land use plan was last updated and adopted in 2000 by the legislature after completion of the 1999 Port Authority of Guam Master Plan. The land use designations that apply to the Commercial Port Area are depicted in Figure 2.1-2 and posted on the Port's website. Designations that were deemed to be applicable to this 2007 Master Plan Update are summarized as follows.

Tract IN - Industrial

This segment of land adjacent to the Route 11 Approach Road has been designated for "Industrial" use. The proposed Cabras Island Industrial Park is slated to be located in this tract.

Track CT – Cargo Terminal

This tract designated "Commercial Port" consists of the existing Cargo Terminal areas and the expansion areas located to the east of the terminal. It consists of some 95 acres of land with access to deep navigable waters of the Cabras Navigation Channel in Apra Harbor. It includes the area currently occupied by the Port Administration Building and associated small buildings located outside the Cargo Terminal fenced area.

Track PC – Piti Channel Area

This tract consists of Piti Channel that flows from the Philippine Sea under the Route 11 Bridge (See Figure 2.1-1) past the Harbor of Refuge for small craft and into Apra Harbor via the Cabras Island Navigation Channel and Port Slips.

Track FI – Fishing Industry Facilities

This tract designated as "Fishing Facilities" includes the segment of land currently occupied by the Port's Warehouse #1, the Equipment Maintenance and Repair Building and adjacent tank area. It is currently located within the Cargo Terminal fence and is contiguous with the terminal. A part but not all of this area is leased and occupied by the CASAMAR Purseiner fishing repair facility. The remainder of the CASAMAR lease area seems to be located in Tract FC.

Tract OS – Open Space Tracts

These tracts designated as "Open Space" include the area nestled between the Cargo Terminal, the Mobil Tank Farm in Tract E and the Seawall to the North. Other relevant tracts designated as Open Space include the area parallel to the road running along the Glass Breakwater between The Seaplane Ramp, Golf Pier, Hotel Wharf, Dog Leg Pier and Family Beach. Fuel pipelines run partly along this tract between Golf Pier and the Tank Farm on Track FC.



Tract FC - Marine Industrial Terminal

The various tenant facilities described under Marine Industrial Terminal in Section 2.3.15 are located within this tract including Pier F-1, the Cement Unloading dock and the CASAMAR upland and building areas. This tract is designated "Fuel Facilities / Cement Import".

Tract S - Seaplane Ramp

This tract consists of the Seaplane Ramp property which is designated "Water Recreation".

Tract G - Golf Pier

This tract consisting exclusively of Golf Pier which is also designated "Fuel Facilities / Cement Import". As discussed in Section 3, this tract is under a management and use agreement with Mobil Oil Guam Inc. and utilized as a Fueling Pier.

Tract H - Hotel Wharf

This tract consisting exclusively of Hotel Wharf seems to be designated as mixed use between "Fishing Facilities" and "Dinner Cruise". As discussed in Section 3, this tract is currently leased by YTK with the lease terms requiring development of Fishing Facilities to support the offshore long-liner Tuna Fishing Industry.

Tract D Dog Leg Pier & Family Beach

This tract consisting of - Dog Leg Pier and Family Beach is designated for "Fishing Facilities" and "Water Recreation". As discussed in Section 3, this tract is currently leased to operations that cater to recreational activities. Family Beach is used by local residents and tourists for picnics, jet skiing and swimming.

ESQD – Explosive Safety Quantity Distance

The Military has designated a number of hazard zones called the "Explosive Safety Quantity Distance" in Apra Harbor. Most are in Inner Apra Harbor which does not seem to impact Port activities and is not shown on the Port website. However one which is demarcated as a circumferential boundary on Figure 2.1-2 at a specific radius from the source of ship board ordinance and other explosive material stored in Outer Apra Harbor. The boundary runs through Outhouse Beach between Hotel Wharf and Golf Pier as shown. In general the following rules apply to areas within an ESQD arc.

- ESQD arc radii are determined by the Military based on the extent and nature of the ordinance stored.
- Inhabited Buildings are prohibited within the designated arc.
- Structures which can collapse onto people and endanger lives are also not permitted.
- Recreational facilities (except facilities for large crowds such as grandstands) are allowed within the outer 40% of the ESQD arc.
- Ship anchorages and wharves (which moor ships) are generally not allowed within the arc.

The above restrictions would apply to Family Beach, Dog Leg Pier and Hotel Wharf which are all within the arc.

2.1.4 Historic Preservation

The Department of Parks and Recreation Guam Historic Preservation Office is responsible for record keeping, monitoring and enforcement of Guam's regulations regarding development at historic sites.

The boundaries of the project were discussed with the State Archaeologist; Guam Historical Resources Division who confirmed that there are no historic artefacts of interest listed in the Historical Register that fall within the proposed commercial cargo terminal project area. We understand that there are archaeological sites in open space areas around the Marianas Yacht Club (See Figure 2.1–2). The officer indicated that since the Project will likely utilize Federal funds, Section 106 of the applicable regulations



would require that developers obtain the necessary clearances from the U.S. Army Corps of Engineers, Honolulu, Hawaii before proceeding with the development.

2.2 Apra Harbor & Navigation Infrastructure

The Port Authority of Guam (PAG) commercial port facilities are located in Apra Harbor on the West coast of Guam. The Apra Harbor layout is depicted in Figure 2.2-1 and consists of Outer Apra Harbor and Inner Apra Harbor. The main navigation channel, anchorages, the commercial port facilities, marinas, other marine industrial facilities and the Navy's Echo and Delta wharves are located in the Outer Harbor. Other Navy facilities including the Navy Dry Docks are located in the Inner Harbor.

More detailed information on the navigational infrastructure around the island of Guam and Apra Harbor are described in the following Nautical Charts:

NOAA	81048	Guam
NOAA	81054	Apra Harbor
British Admiralty	1109	Apra Harbor

Public Law 26-72 "Harbor Rules and Regulations of the Port Authority of Guam" governs Harbor use. Operations within Outer Apra Harbor are controlled by the Port Authority through the office of the Harbormaster. The US Navy controls all operations in Inner Apra Harbor which is a restricted area.

2.2.1 Navigation

Description & Metrics

The main access channel is aligned at 83° (Figure 2-1) from the harbor channel entrance which is 215m wide between Orote Island and Spanish Rocks. Inbound traffic has priority and access is restricted when winds exceed 35 knots. The overall harbor navigation metrics as described in Fairplay or provided by the Harbormaster include:

Traffic figures	Approx 1,850,000t of cargo and 2,139 vessels handled annually.
Load Line zone	Summer.
Maximum Vessel Size	Draft 15.8m, 100,000dwt.
Pilotage	Compulsory for vessels over 500 GRT and available 24 hours per day (Note: Fishing vessels in any event require pilotage first time in harbor)

Once inside the harbor, access to the commercial port facilities and Navy wharves Delta and Echo is to the northeast through Cabras Island Channel which currently seems to have 12m depths. The commercial port berths currently have depths of approximately 11m or less. The main commercial Port facilities are located on approximately 90 upland acres inclusive the commercial cargo terminal and tank farms on Cabras Island.

From the main channel access to Inner Apra Harbor and restricted Navy facilities are at a southeasterly alignment.

According to Fairplay there are six anchorages available in Guam as follow:

Number	Latitude	Longitude	Depth (m)	Notes
501	13°27.2'N	144°37.6'E	43.0	General anchorage
701	13°26.6'N	144°37.5'E	43.6	Military explosive anchorage
702	13°27.4'N	144°28.1'E	39.0	Military explosive anchorage
703	13°27.3'N	144°38.3'E	34.4	General anchorage
704	13°28.6'N	144°38.5'E	36.6	Navy anchorage
951	13°26.5'N	144°38.2'E	89.0	Navy anchorage

Figure 2.2-1 Apra Harbor

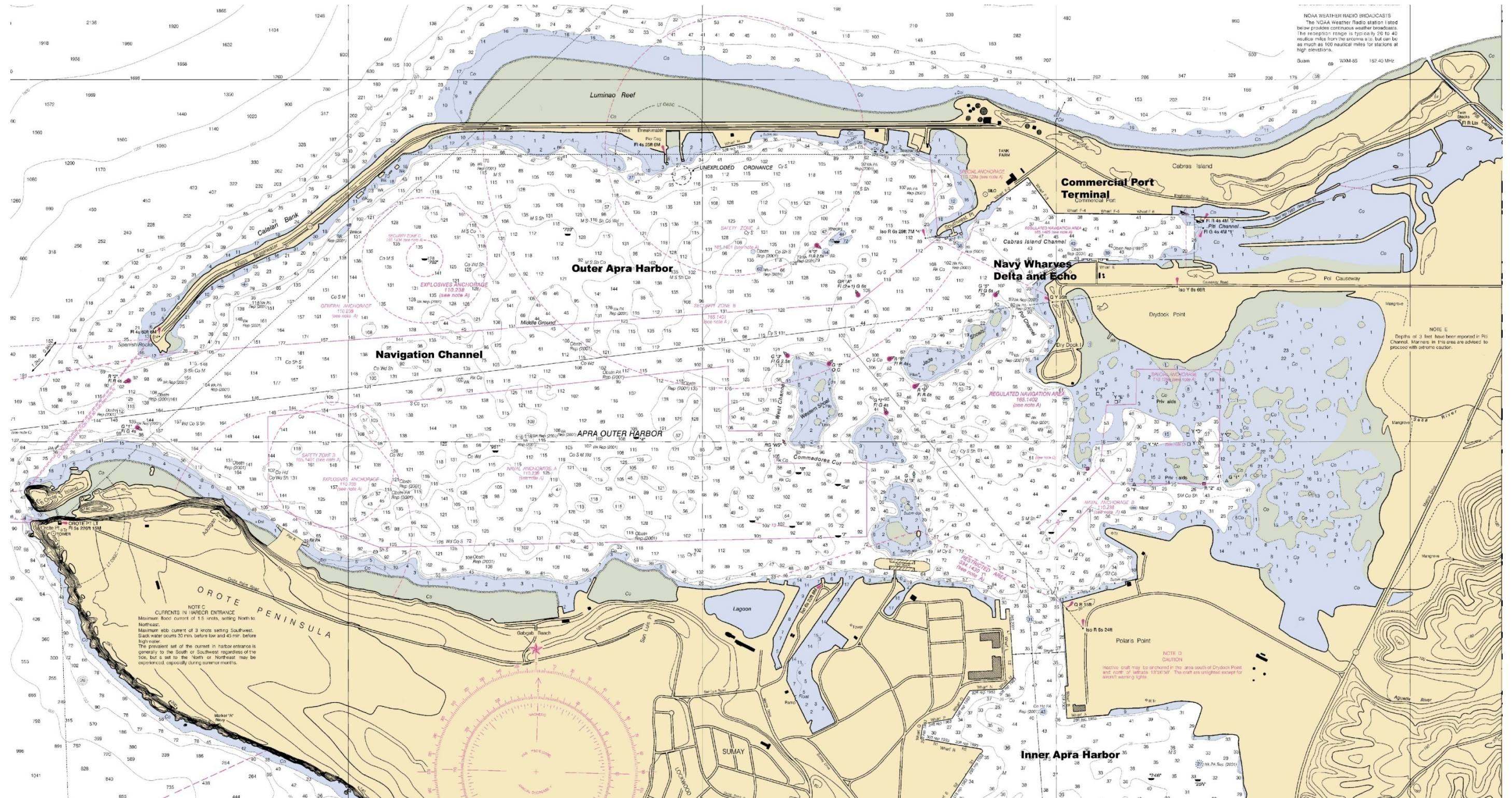

Source: NOAA Charts Rose Point Navigation LLC



The following are the capacities of the tugs available in the harbor through Cabras Marine.

- 2 x 2,600 HP
- 2 x 3,200 HP
- 1 x 2,200 HP
- 1 x 1,800 HP

According to the Harbormaster, two tugs are generally used for navigation of most vessels within the harbor. Sometimes four tugs are used for aircraft carriers.

2.2.2 Navigational Aids

Description

The Federal Aids are identified on the above described charts. The Coast Guard Cutter Sequoia, home-ported in Apra Inner Harbor in Guam, is the only vessel responsible not only for the aids on Guam, but also most of the Marianas Islands as well as Kwajalein Atoll in the Marshall Islands. As a result, response time to correct aids damaged or extinguished on Guam may be delayed due to other priorities.

Note that in addition, there are privately maintained aids at other locations such as the entrance to Agat Marina. The aids at the marina are maintained by the civilian Port Police.

The Fourteenth Coast Guard District, located in Honolulu, Hawaii, publishes a Weekly Notice to Mariners. This publication is distributed via mail, e-mail and internet and advises mariners of navigation matters that may be of immediate concern. Additionally, the Coast Guard broadcasts a Notice to Mariners over the VHF radio on navigational issues that are of immediate and local importance.

Approximately once every five years the Coast Guard conducts a Waterways Analysis and Management System (WAMS) study for the waters around Guam. This is currently in progress as discussed below. The description of the harbor conditions as sourced from *Fairplay Ports & Terminals Guide* is presented below.

Tidal range and flow

Range: 1.1m.

Flow: Off the entrance, the flood stream sets between N and NE and the ebb stream SW, slack water occurring at 30 minutes before LW and 45 minutes before HW. When combined with the SW-going current associated with the NE trades, which is greatly affected by the force of the wind and may on occasions be sufficient to overcome the NE-going stream, the resultant flow has maximum rates of 1.5knots NE-going and 3knots SW-going. Strong tide rips may also be met.

Swell: Heavy W swells sometimes make the harbor entrance dangerous for a period of several days; this occurs when a typhoon is building up in the area and moving NW.

Condition Assessment

At the time of this writing a WAMS study for the waters around Guam is underway by the Coast Guard. According to Coast Guard officials, there have been no comments received yet by the public. Due to other operational commitments the Coast Guard has not been able to complete the WAMS study according to their original schedule, although they do not anticipate any changes to the current aid to navigation system.

With regard to Apra Harbor, this may change if the anticipated military buildup on the island occurs and additional Naval and commercial vessels increase their Port visits or are home-ported there, or new wharves are built or new channels dredged.

Maintenance and Operational Improvements

The Port does not have responsibility for the maintenance of the Federal aids to navigation. If these aids are damaged by storms, the U.S. Coast Guard Cutter Sequoia, stretched thin with responsibility for all Navigational Aids in the region must schedule and repair them.



It is recommended that the Port should provide input on their in-water infrastructure improvements, to the Coast Guard's WAMS study.

2.3 Existing Commercial Port Facilities

Commercial Port Areas

The layout of the Commercial Port facilities is shown on Figure 2.3-1. The facility areas have been categorized by physical location and to some extent function as follows.

Table 2.3-1 Commercial Port Areas

Commercial Port Areas	Acres	Berths	Use
Cargo Terminal	62	F-3 to F-6	Commercial Cargo Terminal
Terminal Expansion Area	39	N/A	Vacant Land designated for terminal use
Marine Industrial Facilities	50	F-1, F-2	Liquid Fuel, Fishing and Marine Industrial Use
Glass Breakwater Area Facilities	N/A	Family Beach Dog Leg Pier Hotel Wharf Golf Pier Seaplane Ramp	Mix of Liquid Fuel, Fishing and Recreational Use

The various uses and tenants in these port areas are described in the following sections. PAG also oversees Agat Marina, Gregorio D. Perez Marina and the Harbor of Refuge. These facilities are described in Section 2.5.

Overview of Berths

The Port has a number of commercial berths to support vessel service for the various types of cargo and civilian marine-industrial activities in Guam. The following table provides an overview of the metrics and description of the various berths.



Table 2.3-2 Berth Overview & Metrics

Berths	Length Ft	Current Depth Ft	Location	Current Use
F-2	670	26	Marine Industrial Facilities Area	Fishing Fleet Repair. Leased to CASAMAR
F-3	750	26	Cargo Terminal	General Cargo, Passenger Vessels, Fishing Vessels
F-4	660	34	Cargo Terminal	Container and General Cargo.
F-5	660	34	Cargo Terminal	Container and General Cargo.
F-6	660	34	Cargo Terminal	Container and General Cargo.
F-1	550	54	Marine Industrial Facilities Area	Liquid Bulk, LP Gas. Operated by Shell Oil, Guam.
Cement	N/A	24	Marine Industrial Facilities Area	Floating barge for cement unloading
Hotel	500	26	Glass Breakwater	Fishing vessels and dinner cruises
Golf Pier	370*	40	Glass Breakwater	Liquid Bulk Tankers. Operated by Mobil Oil, Guam (* bulkhead)

Source: Harbormaster & interviews

Berth F-3 is used primarily for fishing vessels and tenants performing fishing operations while Berths F-4 to F-6 accommodate containerships, general cargo vessels, and passenger ships. Each of these four berths can service container vessels with a maximum beam of 107 feet. In addition, the Port has two berths (Pier F-1 and Golf Pier) for fuel tankers and Hotel Wharf, all managed by the private sector. Bulk Cement is handled by Hanson Permanente using a floating barge at a seawall location North of F-1.

The Port compound is comprised of 26.5 net acres used currently for container storage space, along with maintenance and repair facilities encompassing approximately 54,000 square feet, and two warehouses providing approximately 110,000 square feet of floor space. The storage yard provides space for containers, automobiles, and general cargo. The container yard also includes 95 stalls equipped with plug-ins to serve refrigerated containers.

Overview of Building Structures

Most of the building structures in the Port were built and put in service in the late 1960s. They seem to have been robustly designed in the style of military building to withstand the extremely high wind conditions caused by Typhoons. The majority are constructed of 3,000psi (pounds per square inch) concrete and 20,000psi reinforcement steel. The lateral force was dominated either by wind load (160 MPH/200 MPH for WDS/USD method) or earthquake load (Zone 3 per UBC 1964 edition).

Shallow footings (spread type or strip type), 1.5~3 ft. below the finish floor elevation of 1st floor, were utilized to support the building/structures. The allowable soil pressure was designed based on 1100 psf for footings 2.5 ft. wide, and 2500 psf. (pounds per square foot) for footing width greater than 10 ft. Straight line interpolation applied for footing widths between 2.5 ft. & 10 ft.

The layout of the existing building structures in the Cargo Terminal Area is shown on Figure 2.3-2. Condition assessments of each major building structure are presented in the following sections.

Figure 2.3-1 Guam Commercial Port Facilities Location Map

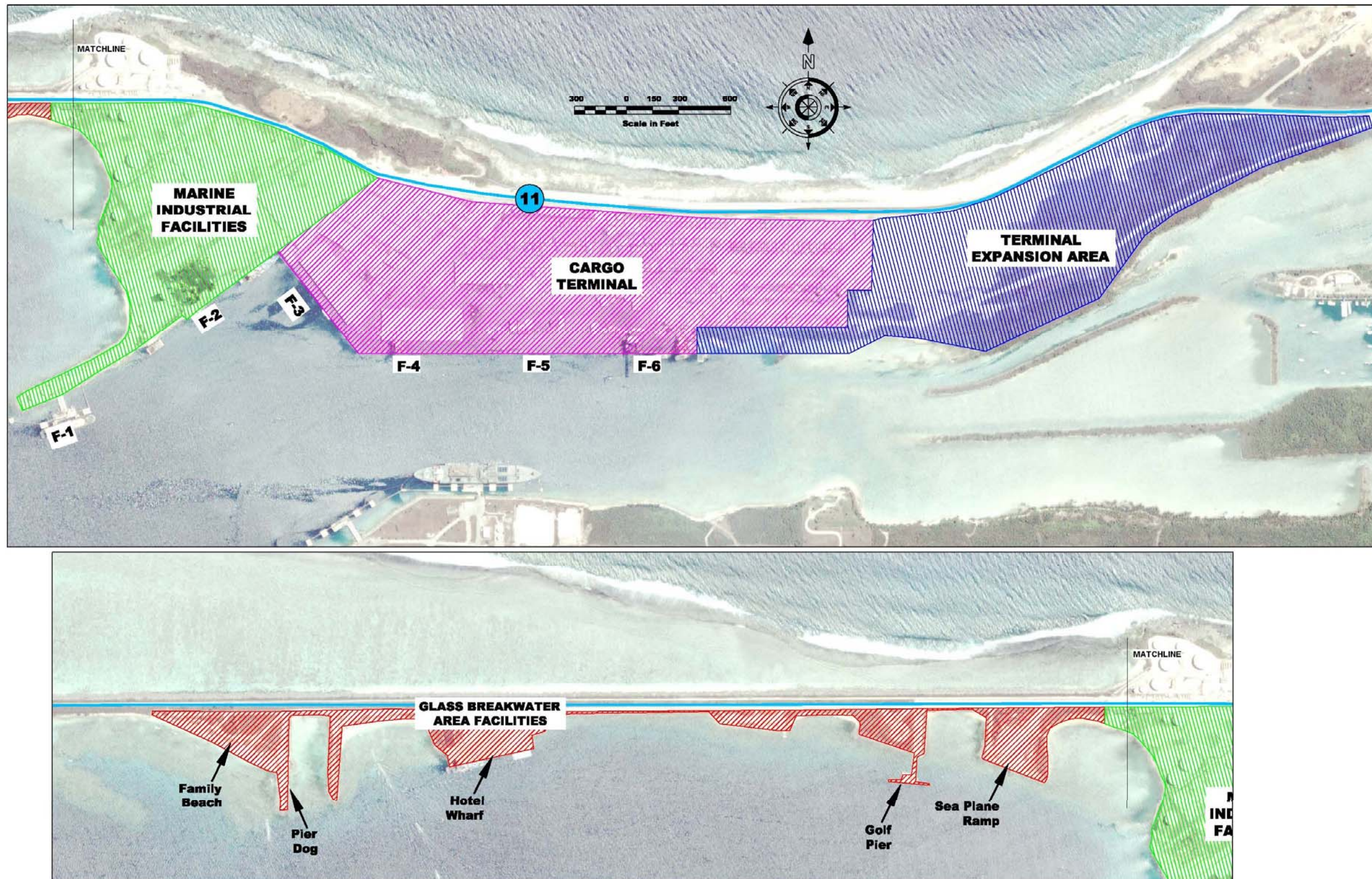
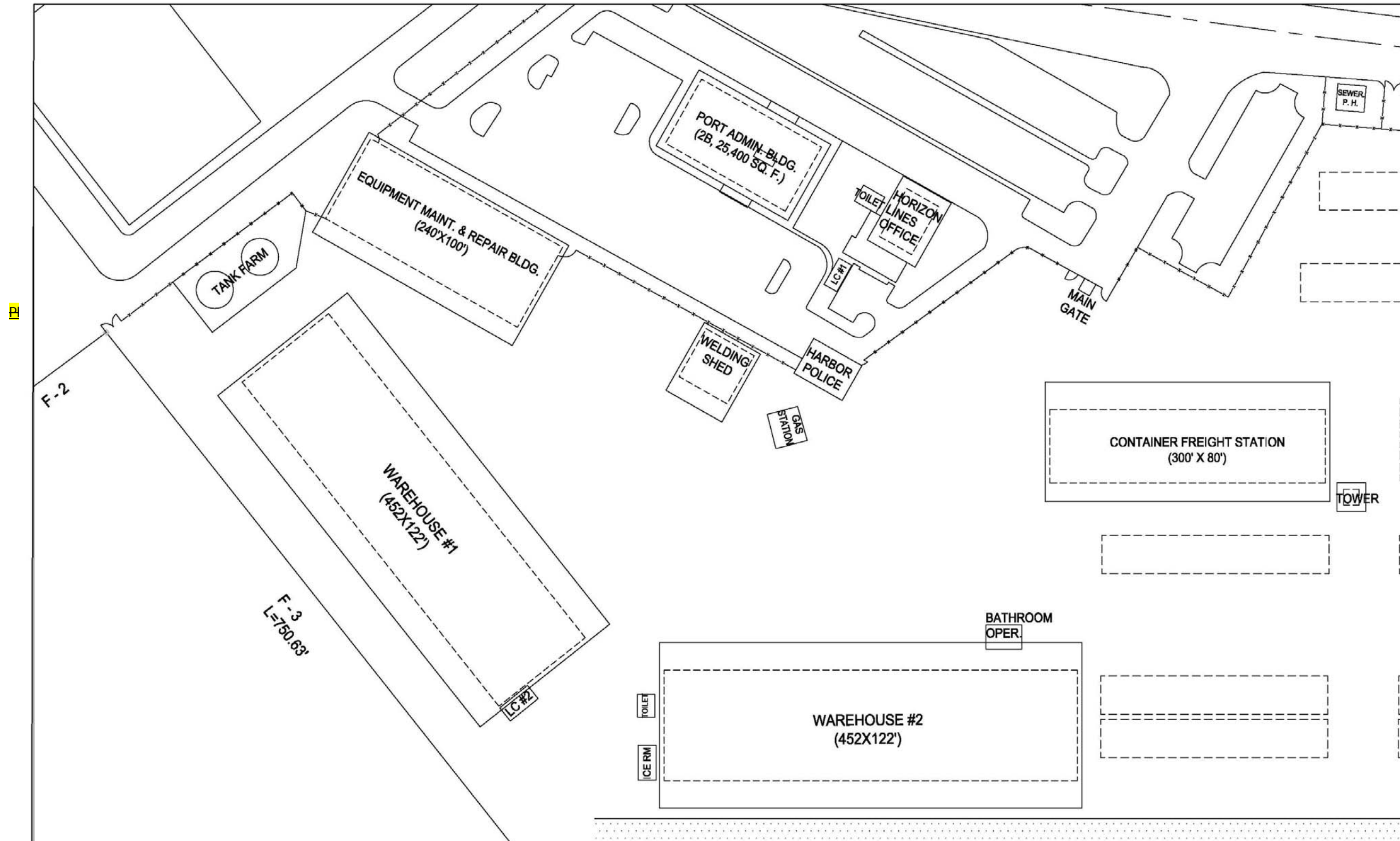

Figure 2.3-2 Cargo Terminal Area Buildings Structures





Overview of Equipment

Cargo is handled by equipment that includes 3 rail mounted gantry cranes (40 LT capacity) one of which is inoperable , 2 rubber tire gantry cranes (40 ST capacity), 1 mobile harbor crane (104 ton capacity), 1 top lifter, 4 side loaders, 2 20-ton heavy lift forklifts, 24 tractor-trailers, and a fleet of forklifts of various load capacities. The maximum reach from the waterside rail by the land-based gantry cranes with spreader is 115 feet; the maximum lifting height above the quay level at maximum reach is 72 feet for Gantry No. 2 and 80 feet for Gantry No. 3 More detailed descriptions of these facilities are presented in the following sections. More detailed information on the various equipment is presented in Section 2.3.3.

2.3.1 Berths F-2 through F-6

Location: Cargo Terminal, See Figure 2.3-2.

Description & Metrics

Berths F-2 through F-6 were built and placed in service in the 1960s. The structure consists of tied back sheet pile walls with concrete caps. Sheet pile walls are also used as the upland anchor (deadman) below ground level.

The Guam earthquake of 1993 severely damaged sections of the wharf structures. Because of this damage, an 560 foot section of the wharf at Berths F-5 and F-6 was replaced by a pile-supported structure. Pre-stressed concrete piles were driven to support cast-in-place concrete beams and slabs. New sheet pile walls were driven at each end of the new wharf section to contain the fill laterally. The damaged sheet piles were cut near the seabed to suit the new slope under the wharf section. Rip rap was placed above the new slope. A section of the pile-supported beams which carry the crane rails was replaced after the 1993 earthquake. New pre-stressed concrete piles were driven and new sections of the beams were cast next to the existing ones.

Condition Assessment

A visual, one-day condition survey of berths F-2 through F-6 was conducted both on land and from a boat. The existing fenders are damaged at several locations and will need to be replaced in the future. The pile-supported section of the berths which was built to replace the damaged portion after the 1993 earthquake seemed to be in very good condition and can continue to be used in the future.

Based on discussions with Oceaneer Enterprises Inc., which has done numerous inspections of the facility over the years, it was clear that time has taken its toll on the sheet piles. They mentioned that the sheets are badly deteriorated and corroded. This is to be expected considering the harsh environment and the lack of protection provided for the structure.

The concrete coping beam above the sheet piles also has considerable deterioration. The beam has large number of cracks and spalling has occurred in many places.

Wharf F-2



Wharf F-3



Wharf F-4



Wharf F-5 / F-6



Maintenance and Operational Improvements

It was clear during the condition survey that the structures have not been maintained on a regular basis. The damage to the fenders and the coping beam is extensive and also no corrosion protection system has been employed in order to protect the sheet piles on the older structures. Major work to replace the sheet pile supported sections of the facility will be necessary as part of a modernization plan for the Port of Guam.

2.3.2 Container Crane Rails on at Berths F-4, F-5 & F-6

Location: Cargo Terminal, See Figure 2.3-2.

Description/Metrics

In 1970, a 50 foot gage ship to shore crane runway was constructed at berths F-4, F-5, and F-6. The concrete runway girders, measuring 2' X 2.5' in cross section, are supported on vertical steel H piles spaced at 9 feet on centres. The piles are located in between the tie rods of the sheet pile wall. The gage is held by concrete cross beams spaced at 54 feet on center for the full length of the runway. The crane runway structure is supported independently of the wharf structure.

During the 1993 earthquake, damage occurred in the crane runway within the length of the wharf that was damaged during the same seismic event. The lateral movement of the wharf structure caused the crane runway to move laterally and sustain permanent (plastic) deformation. New piles were added after the earthquake in order to repair the crane runway. The new piles were staggered with the existing ones and spaced at 9 feet on centres as well. The existing concrete rail beams were widened to correct the alignment of the rails. The extent of the repair to the crane runway matched the length of the pile-supported wharf that was built to replace the damaged portion of the sheet pile original structure, (560 feet).

Crane Rails at F-4, F-5 and F-6



Condition Assessment

A detailed survey of the entire crane runway was not possible during the one day site visit due to the crane operations. Only the end portions away from the cranes were accessible. Those portions did not show major deficiencies in terms of the components of the rail.

Maintenance and Operational Improvement

It is our understanding that the Port is currently engaging a consultant to conduct a survey of the crane rails due to difficulty in crane movement along the rails. The permanent damage that happened to the structure during the 1993 earthquake may have caused the piles to move sideways due to plastic deformations. This could be one of the factors that caused the rails to move making it difficult for the crane travel along the rail. Some strengthening or total replacement of the rail supporting structure may be necessary in order to remedy this problem. This should be investigated as part of an overall modernization program for the terminal.

2.3.3 Cargo Handling Equipment

Location: Cargo Terminal

Interviews were conducted with PAG operations staff and observations were made by consultants during tours of the container facility. In addition, interviews were conducted with stakeholders, i.e. steamship lines, truckers and other facility users, to get their viewpoint on equipment capability.

Description & Metrics

The equipment list presented below was compiled from information on the PAG web site and a copy of a PAG presentation given at the Guam Industry forum. A summary of the current equipment inventory is shown in Table 2.3-3 below.

Table 2.3-3 List of Cargo Handling Equipment

EQUIPMENT	NO.	AGE	CAPACITY	COMMENTS
Container cranes	3	See Below	40 ton	One crane is inoperable; Second Crane is prone to breakdown. All are undersized for future service requirements.
Mobile Harbor Crane	1	7 yrs	104 L/T under hook	Acquired used by PAG in 2007
Grove H/L crane	1	N/A	150 ton	This crane is scheduled for survey and, for all intents and purposes is no longer available
RTGs	2	17 yrs.	45 ton	Both are obsolete
Top Picks	2	20 & 18 yrs.		Both have exceeded useful life
Side Picks	4	10-12 yrs.		Used for handling empty containers
Yard Trucks	24	16 – 10 yrs. 8- 1 yr		The older trucks were acquired in 1998 and should be replaced. The 8 newer trucks were acquired in 2007
Forklifts	12	10 -20 yrs.	3.5 – 20 ton	Up to 10 replacement forklifts are planned in 2008
Bomb carts (Yard Chassis)	0	N/A		There are currently no bomb carts on the PAG inventory list

Condition Assessment

Cranes

There are three Container Cranes (rail mounted ship service cranes) of which one is inoperable and we understand is to be scrapped. The Container Cranes are in general 25 to 30 years old (1983 for the Hitachi and 1979 for the two Paccos) and obsolete. There are no spare parts off the shelf in the island and the parts need to be made to order. The average downtime for the Container Cranes is 3 to 4 hours per week and in general is caused by failure of non major components such as limit switches, etc. Corrosion is a major problem for the electrical and metal components at the Cargo Terminal.

PACECO Corporation conducted a survey of Gantry Crane #2 in November, 2007. The report details an extensive list of maintenance issues, primarily as the result of corrosion, that need immediate and continuing attention if PAG intends keep the crane operational. The report also recommended having another crane available in the event that maintenance cannot keep up with the rate of decay due to corrosion.

RTGs

There are only two RTGs (Rubber Tire Gantry Cranes) available. Both have limited stack width and stack height consistent with first generation RTGs. The RTGs are obsolete and incompatible with a modern efficient coordinated RTG yard operation.

Maintenance and Operational Improvement

Based on the information that was provided via discussions with PAG operations staff and terminal users in addition to observations in the field, it is clear to the Consultant that the current inventory of equipment is not sufficient to handle a substantial increase in volume. Virtually all the stakeholders interviewed saw the equipment inventory as an impediment to the Port's efficiency and as being inadequate to handle increased volume over the terminal. In fact, there was some question as to the equipment capability to handle existing volume reliably.

Following the final analysis of the requirements under an increased volume scenario and recommended handling methods, new equipment will need to be acquired on an expedited time line. In addition to handling equipment, an updated automated terminal operating system will likely be required in order better manage container movement and tracking as well as maintenance.

It is also critical that the Port acquire a second reliable container crane in a timely manner before occurrence of a major container crane breakdown.

2.3.4 Container & Cargo Storage Yard

Location: Cargo Terminal, See Figure 2.3-2.

Description & Metrics

The Container Yard (Yard) is a 26.5 acre area paved with reinforced concrete, confined by CMU walls & chain-link fences. The pavement is formed by 6 in. base-course (100% compaction ratio), 12 in. concrete slab (600 psi), cast with #4@10 in. E.W. rebar. Another 10 acre area (Phase-II increment) located adjacent to the existing yard was designed in 1998, but has not yet been built.



Concrete wheel stops are installed at each chassis stall. Lighting poles inside yards are supported by RC spread footing (7 x 7 x 1.5 ft.) and 20 x 20 in. pedestal, the bottom elevation of footing is located 6 ft. under finished grade. Some holding-down anchors were also observed on the pavement.



The pavement was designed to be able to support 3 block-stacked 40-foot containers, and also to provide running surface for Port equipment as described in a later section.

The pavement was first constructed between 1990~1991, and was retrofitted in 1997 due to the earthquake damage. The retrofitted area is located behind Berth F-5 in an area 818 X 255 ft. The paved surface has been replaced by 24-inch RC slab, which is integrated with beams & piles as part of the structural system of the pier.

Condition Survey

Only some minor cracks were observed on the pavement, no noticeable structure deficiencies were found on the pavement by the facility survey. Ponding in some limited areas was observed.

Maintenance and Operational Improvement

Regular maintenance to correct above described yard paving deficiencies is necessary.

2.3.5 Truck Gates

Location: Cargo Terminal, See Figure 2.3-2.

Description & Metrics

An entrance gate is located at the north-east corner of the Yard as the truck gate and check point into and out of the Cargo Terminal. The gate was built in 1990~1991. It includes two queuing lanes each for exit and entry.

The gate is a reinforced concrete structure, with a 19 ft. height, and 80 by 64 ft. footprint. A single floor RC booth (10 ft. high, 14 by 64 ft. footprint) is shaded by the gate at the center span; 30 ft. span with 16 ft. head clearance at both sides of the gate.



The structural elements of the gate are:

- | | |
|-------------------------|--------------------------------|
| ◆ Spread footing | CF1 66 x 66 x 16 in. |
| ◆ Spread footing | CF2, CF3 72 x 72 x 16 in. |
| ◆ Spread footing | CF4 90 x 90 x 16 in. |
| ◆ Strip footing (booth) | 18~24 x 12 in. |
| ◆ Column | 24x20, 20x20, 20x16, 16x16 in. |
| ◆ Beam | B=12~18 in., D=24~36 in. |
| ◆ Roof | t=5 in. |
| ◆ On-grade Slab (booth) | t=5 in. |
| ◆ Wall | 8in. CMU |

Condition Survey

The gate structure physically is in good condition. Due to the orientation of the gates queuing length for trucks for entry or exit is limited.

2.3.6 Fencing

Location: Cargo Terminal, See Figure 2.3-2.

Some chain-link fence gates, either for vehicles (by-parting type, w=24~60 ft.) or for pedestrians (swing type, w=3.5 ft.), were observed along the north and west boundaries.

Two types of yard fence were observed, (1) CMU wall with one side outrigger with 3 strands barbed wire angled outward; or (2) chain-link fence with vinyl coated fabric and G.I. pipe posts.



Traps for Brown Tree Snake are attached to the fences around the yard.

Condition Survey

Significant corrosion was observed on the metallic part of gates and fences.

Maintenance and Operational Improvement

Corrosion protection for metal components is recommended.



2.3.7 Port Administration Building

Location: Cargo Terminal, See Figure 2.3-2.

Description & Metrics

Port Administration Building (Admin Bldg.) serves as the administrative headquarters of the Port Authority, and also accommodates many of the shipping and shipping related organizations. PAG is the landlord for these tenants.

The building is a 2-story structure, built with reinforced concrete with 7 grids (grid 1~7, transverse frame spanning 25' typically) along E-W axis, and 4 grids (grid A~D, longitudinal frame spanning 25-30-25') along S-N axis, cantilevered eave extended 7.5 ft. on four sides. The stair-core is protruded to the roof providing access to the observation area.



The building's tenant name, locations and other metrics are presented in the following table.

Table 2.3-4 Port Admin Building Tenants

Tenant	Rm. No.	Lease Start Date	Area Sq. ft.	Purpose
Ambyth Shipping & Trading	A205	1995/12/13	1204	Agent
Ambyth Shipping & Trading	A222	1995/12/13	502	Agent
Ambyth Shipping & Trading	A219	1995/12/13	216	Agent
American Bureau of Shipping	A223	1999/01/01	192	Marine Surveyor
AR Sunriser Canteen/Catering	Across Admin	2006/06/14		Food Concession
Cabras Marine Corporation	A111	1997/10/01	980	Admin
Cabras Marine Corporation	A110	1997/10/01	366.25	Admin
Customs and Quarantine	A106		788	Gov
Dongwon Industries Co., Ltd.	A108-109	2001/05/01	557	Agent Admin
Inchcape Shipping Services/CTSI	A116	1999/02/01	1250	Agent
IT&E Overseas	A225	2004/07/01	180	Teleco
Matson Navigation Company	A115	1996/02/01	2755	Agent/Carrier Office
Matson Navigation Company	A103-104	1996/08/01	435	Agent/Carrier Office
Unterberg Jurgen/Guam Oceaneer Ent.	A113	1994/04/01	206	Marine Surveyor

Some overall metrics describing the building are listed below; typical sections are extracted from the as-built drawings and provided with Appendix 2-2.

- ◆ Date of construction: 1967~68
- ◆ Number of floors: 2
- ◆ Building footprint: 152.4 ft. by 82.4 ft.
- ◆ Building floor area: 25,400 sq. ft.
- ◆ Height of roof eave above ground (no included the protrusion) Approx. 28 ft.
- ◆ Primary load structural system: RC columns with Flat Slab
 Perimeter columns 24 x 14 in.
 1F Interior column 18 x 18 in. with drop panel 10 x 10 ft. x 5 in.
 2F Interior column 14 x 14 in. with drop panel 10 x 10 ft. x 5 in.
 Flat Slab (2F & RF) t=10 in.
- ◆ Foundation system: Spread footing 11 x 11 x 2 ft.
 Strip footing 5 x 1.67 ft.
 Slab-on-grade t=5 in.
- ◆ Wall RC t=10~14 in. for exterior wall
- ◆ Stair & Step RC with steel pipe handrail
 2@ fire escape stairs (1F & 2F)
 1@ interior stairs (1F & 2F)
 2@ steps (entrance)
- ◆ Miscellaneous 2@ RC Entrance Canopy 35 x 16 ft.
 Rigid frame (bm/col) system for int. stair core & duct shaft
 Roof Protrusion: Area 23.5 x 10 ft., H=9.5 ft.

Condition Assessment

No major noticeable building flaws were noted during the assessment.

Maintenance and Operational Improvement

The building appears to be acceptable for its current use. However, for such buildings constructed 35+ years ago, a code compliance check (especially seismic design aspects) is strongly recommended.

2.3.8 Horizon Lines Building

Location: Cargo Terminal, See Figure 2.3-2.

Description & Metrics

Horizon Lines Building is tenanted by Carriers and Agents as listed below. The building is established by two portions, the high roof portion (HR) located at the north side, and the low roof portion (LR) located at the south end. The electrical Load Center #1 is located behind this building.



Table 2.3-5 Horizon Office Building Tenants

Tenant	Rm. No.	Lease Start Date	Area Sq. ft.	Purpose
Horizon Lines LLC.	AA	2002/01/01	4155	Agent/Carrier
Marianas Steamship Agencies	AA	1996/05/01	1116	Agent
Marianas Steamship Agencies	AA	2004/07/01	160	Agent Storage (open space)



Some overall metrics describing the building are listed below; typical sections are extracted from the as-built drawings and provided in Appendix 2-2.

- ◆ Date of construction: 1967~68
- ◆ Number of floors: 2
- ◆ Building footprint: 89.6 ft. by 40.0 ft. (High Roof portion, HR)
64.6 ft. by 62.0 ft. (Low Roof portion, LR)
- ◆ Building floor area: 10,400 sq. ft.
- ◆ Height of roof eave above ground: Approx. 18 ft.
- ◆ Primary load structural system: RC columns with Flat Slab
Columns 24 x 24 in. (HR)
9 in. shear wall (LR)
Flat Slab (HR, RF) t=14 in.
Flat Slab (LR, RF) t=6 in. min.
- ◆ Foundation system: Spread footing 9.5 x 9.5 x 2 ft.
Strip footing 6.5 x 2 ft. (HR)
Strip footing 2.5 x 1.5 ft. (LR)
+ Slab-on-grade t=5 in.
- ◆ Wall: RC t=9 in.(ext.) or 7in. (int.)
- ◆ Stair & Step: 1@ fire escape stair, Steel step with steel pipe handrail
- ◆ Miscellaneous: Steel Deck (?) added in HR area

Condition Survey

Significant corrosion was observed on the exterior stairs. No other visible building deficiencies were noted during the assessment.

Maintenance and Operational Improvement

The building appears to be acceptable for its current use. However, for such buildings constructed 35+ years ago, a code compliance check (especially seismic design aspects) is highly recommended.

2.3.9 Container Freight Station

Location: Cargo Terminal, See Figure 2.3-2.

Description & Metrics

Container Freight Station (CFS) is now used as a repair facility and maintenance shop by organizations such as Carrier and Tug Support (tenants, see below). PAG Department of Transportation is also using the area under the eave of B7~B9.



The building is a reinforced concrete structure with 11 grids (grid 1~11, transverse frame spanning 30' typically) along E-W axis, and 2 grids (grid A & C, longitudinal frame spanning 80') along S-N axis, cantilevered canopy extended from north and south elevations.



Table 2.3-6 Container Freight Station Building Tenants

Tenant	Rm. No.	Lease Start Date	Area Sq. ft.	Purpose
Cabras Marine Corporation	B10	1997/08/01	3600	Tug Support
Cabras Marine Corporation	U/E B10	1997/08/01	4050	Tug Support
Matson Navigation Company	B5~B9	1996/02/01	10800	Agent/Carrier
Matson Navigation Company	B5~B9 U/E	1996/02/01	9750	Agent/Carrier
Matson Navigation Company	North-east open space	2000/05/15	2130	Agent/Carrier
Horizon Lines LLC.	B1~B4		9600	Agent/Carrier
Horizon Lines LLC.	B1~B4 U/E	11705		Agent/Carrier
Horizon Lines LLC.	N open space	5130		Agent/Carrier

Note: U/E: under eaves

Some overall metrics describing the building are listed below; typical sections are extracted from the as-built drawings and provided with Appendix 2-2.

- ◆ Date of construction: 1968~69
- ◆ Number of floors: 1
- ◆ Building footprint: 300 ft. by 80 ft.
- ◆ Roof projection: 310 ft. by 130 ft.
- ◆ Building floor area: 24,000 sq. ft.
- ◆ Height of roof eave above ground: Approx. 26 ft.
- ◆ Primary load structural system: RC spatial rigid frame System
 - Perimeter column (tapered bottom) 66~42 x 28 in.
 - Beam (taper) 28 x 94.5 in. (transverse frame, mid-span of grid 2~10)
 - Beam (taper) 28 x 48 in. (transverse frame, mid-span of grid 1 & 11)
 - Beam 16 x 74 in (longitudinal frame, grid A & C)
 - Ridge beam 2@ 16 x 27 in (longitudinal frame, grid B)
 - Beam 20 x 34 in (longitudinal frame, between grid A~B & B~C)
 - Beam 20 x 34 in (longitudinal frame, between grid C & edge beam)
 - Edge beam 20 x 20 in (longitudinal frame, edges of cantilever canopy)
 - Pre-cast panel (RF) t=8 in.
- ◆ Foundation system:
 - Spread footing 20 x 14 x 2.83 ft. (grid 2~10)
 - + Spread footing 13 x 10 x 1.83 ft. (grid 1 & 11)
 - + Strip footing 5.0 x 1.5 ft. (grid A & C)
 - + Strip footing 6.5 x 1.5 ft. (grid 1 & 11)
 - + Slab-on-grade t=8 in.
- ◆ Wall RC t=12 in. (grid A & C) or 10 in. (grid 1 & 11) for exterior wall

Condition Survey

Concrete patching was found on columns and walls probably due to seismic damage. No other visible building deficiencies were noted during the assessment.

Maintenance and Operational Improvement

The building appears to be acceptable for its current use. However, for such buildings constructed 35+ years ago, a code compliance check (especially seismic design aspects) is strongly recommended.

2.3.10 Equipment Maintenance & Repair Building

Location: Cargo Terminal, See Figure 2.3-2.

Description & Metrics

Equipment Maintenance & Repair Building (EQMR) is located behind Warehouse 1. It is used for maintenance and repair by the equipment maintenance and repair personnel it also houses the supply management function of the Port... The building is a reinforced concrete structure with 13 grids (grid 1~13, transverse frame spanning 20' typically) along E-W axis, and 4 grids (grid A ~ D, longitudinal frame spanning 30'-40'-30') along S-N axis, cantilevered canopy extended from south elevation. Two small areas of mezzanine (440 sq. ft. for office & 600 sq. ft. for tool room) are located inside the building. An open yard space (100 ft. by 60 ft.) for equipment storage and staging is located at the east side of the EQMR building.



Some overall metrics describing the building are listed below; typical sections are extracted from the as-built drawings and provided with Appendix 2-2.

- ◆ Date of construction: 1967~68
- ◆ Number of floors: 1
- ◆ Building footprint: 240 ft. by 100 ft.
- ◆ Roof projection: 250 ft. by 125 ft.
- ◆ Building floor area: 24,000 sq. ft.
- ◆ Height of roof eave above ground: Approx. 25 ft.
- ◆ Primary load structural system: RC spatial rigid frame System
 - Perimeter column grid A (tapered bottom) 42~24 x 26 in.
 - Perimeter column grid D 18 x 26 in.
 - Inner column 18 x 18 in.
 - Beam (taper) 26 x 42 max. in. (transverse frame, grid 1 ~ 13)
 - Beam 16 x 42 in (longitudinal frame, grid A & D)
 - Beam 16 x 20 in (longitudinal frame, grid B & C)
 - Ridge beam 2@ 16 x 20 in (longitudinal frame, between grid B~C)
 - Edge beam 16 x 16 in (longitudinal frame, edges of cantilever canopy)
 - Pre-cast panel (RF) t=8 in.
- ◆ Foundation system:
 - Spread footing F1 9 x 9 x 2 ft.
 - Spread footing F2 11 x 11 x 2.25 ft.
 - Spread footing F3 12 x 12 x 2.5 ft.
 - Spread footing F4 7 x 7 x 2 ft.
 - Spread footing F5 9 x 10 x 2 ft.
 - + Strip footing 4.5 x 1.25 ft. (Grid A & D, between grid 1 & 6)
 - + Strip footing 4.0 x 1.25 ft. (Grid A & D, between grid 6 & 13)
 - + Strip footing 6.5 x 1.25 ft. (Grid 6)
 - + Strip footing 3.0 x 1.25 ft. (Office Area)
 - + Slab-on-grade t=7 in.
- ◆ Wall: RC t=10 in. for exterior wall & interior wall (grid-6)
- ◆ Miscellaneous:
 - 5@RC ramp 10 x 10.2 ft. (t=7 in.)
 - RC Service Slab 100 x 60 ft. (t=7 in.)

Condition Survey

Concrete patching was found on columns and walls probably due to seismic damage. No other visible building deficiencies were noted during the assessment.

Maintenance and Operational Improvement

The building appears to be acceptable for its current use. However, for such buildings constructed 35+ years ago, a code compliance check (especially seismic design aspects) is strongly recommended.

2.3.11 Warehouses 1 & 2

Location: Cargo Terminal, See Figure 2.3-2.

Description & Metrics

Warehouses (W1 right above & W2 below) are twin-structures, standing side-by-side behind Berths F-3 & F-4. Apart from spaces in W2 which is office space for Port personnel, the rest is occupied by Fishery and Agent tenants (see tenant list below).

Departments of PAG (Operation Dep. Riggers, Police, etc.) are also located in sheds (W1 B14~B15 PAG Electrical storage, W2 B1~B3 PAG Operation Dep., B4~B6 PAG Operation Dep. warehouse, B7~B8 PAG Riggers, B13~B15 Port Police). Vacant spaces are found in W1 (B5~B10, B14~B15).

The buildings are reinforced concrete structures with 16 grids (grid 1~16, transverse frame spanning 30' typically) along E-W axis, and 4 grids (grid A ~ D, longitudinal frame spanning 40' typically) along S-N axis, cantilevered canopy extended from north and south elevations.



The Electrical Load Center #2 is attached to the east side of W1; Two bathrooms (public toilet) and ice maker facility house (footprint 40 x 18.3 ft.) are located on the west side of W2.

Table 2.3-7 Warehouses 1 & 2 Tenants

Tenant	Bay No.	Lease Start Date	Area Sq. ft.	Purpose
Pacific Rim Ice & Fish Packing Svcs Inc,	W1 B1	1999/11/16	3600	Agent Storage
Fungi Li Fisheries Inc	W1 B2	2005/5/16	3465 +1512	Fishery
Fungi Li Fisheries Inc	W1 B2	2005/5/16	320	Fishery (open space)
Tidewater Distributers	W1/B3-4	2004/5/1	6201 +510	Agent Fishery
Kooyoo Pacific Fisheries	W1 B9	2005/8/1	288	Fishery
Sanko Bussan	W1 B10	1997/12/26	4200 +1200	Agent Fishery
RRG Inc.	W1 B10	2004/9/2	312	Agent Fishery
Koueki Pacific Corporation Inc.	W1 B11/12	2005/11/1	6880	Fishery

			+1200	
Koueki Pacific Corporation Inc.	W1 B11/12	2005/11/1	780	Fishery (open space)
RRG Inc.	W1 B13	2004/9/2	3400 +200	Agent Fishery
Pacific Rim Ice & Fish Packing Svcs Inc,	W1 U/E	1999/11/16	800	Agent Storage
Pacific Network Inc.	W1 U/E	2004/7/1	1600	Fishery
Kooyoo Pacific Fisheries	W2 B3	2004/5/1	647	Fishery
Tidewater Distributers	W2 B9	2005/11/1	3395	Agent Fishery
RRG Inc.	W1 B13	2004/9/2	320	Agent Fishery
Ocean Fishery LLP	W2 B15	2006/3/1	2338	Agent

U/E: under eaves

Some overall metrics describing the building are listed below; typical sections are extracted from the as-built drawings and provided with Appendix 2-2.

- ◆ Date of construction: 1967~68(W1), 1968~69(W2)
- ◆ Number of floors: 1
- ◆ Building footprint: 452 ft. by 122 ft.
- ◆ Roof projection: 560 ft. by 180 ft.
- ◆ Building floor area: 54,000 sq. ft.
- ◆ Height of roof eave above ground: Approx. 28 ft.
- ◆ Primary load structural system: RC spatial rigid frame System
 - Perimeter column grid A & D (tapered bottom) 66~42 x 28 in.
 - Inner column grid B & C 24 x 24 in.
 - Beam (taper) 28 x 74 max. in. (transverse frame, grid 2 ~ 15)
 - Beam 28 x 104.5 in. (transverse frame, grid 1 & 16)
 - Beam 16 x 66 in (longitudinal frame, grid A & D)
 - Beam 20 x 34 in (longitudinal frame, grid B & C)
 - Beam 20 x 34 in (longitudinal frame, between grid A & B, grid C & D)
 - Beam 20 x 34 in (longitudinal frame, between grid A, D & edge beam)
 - Ridge beam 2@ 16 x 27 in (longitudinal frame, between grid B~C)
 - Edge beam 20 x 16 in (longitudinal frame, edges of cantilever canopy)
 - Pre-cast panel (RF) t=8 in.
- ◆ Foundation system:
 - Spread footing 18 x 13 x 2.33 ft. (grid A & D)
 - Spread footing 16.25 x 10.25 x 2.17 ft. (grid B & C)
 - Spread footing 10 x 13 x 1.5 ft. (Corner)
 - + Strip footing 5.0 x 1.5 ft. (Grid A & D w/o RC slope)
 - + Strip footing 3.0 x 1.5 ft. (Grid A & D w/ RC slope)
 - + Strip footing 6.5 x 1.5 ft. (Grid 1 & 16 w/o RC slope)
 - + Strip footing 1.67 x 3.17 ft. (Grid 1 & 16 w/ RC slope)
 - + Slab-on-grade t=8 in.
- ◆ Wall: RC t=10 in. for exterior wall
- ◆ Miscellaneous: 16@RC slope 20 x 10.2 ft. (t=7 in.)
bathrooms & Ice maker facility house RC 1F structures

Condition Assessment

Concrete patching was found on columns and walls probably due to seismic damage. No other visible building deficiencies were noted during the assessment.

Maintenance and Operational Improvement

The building appears to be acceptable for its current use. However, for such buildings constructed 35+ years ago, a code compliance check (especially seismic design aspects) is strongly recommended.

2.3.12 Welding Shed

Location: Cargo Terminal, See Figure 2.3-2.

Description & Metrics

Welding Shed- is located at on the east side of the EQMR building. The building is a reinforced concrete structure with 4 grids (grid 1~4, transverse frame spanning 20' typically) along E-W axis, and 3 grids (grid A ~ C, spanning 30' typically) along S-N axis, cantilevered canopy extended from south elevation.



- ◆ Some overall metrics describing the building are listed below; typical sections are extracted from the as-built drawings and provided with Appendix 2-2.
- ◆ Date of construction: 1968~69
- ◆ Number of floors: 1
- ◆ Building footprint: 61 ft. by 60 ft.
- ◆ Roof projection: 80 ft. by 70 ft.
- ◆ Building floor area: 3,600 sq. ft.
- ◆ Height of roof eave above ground: Approx. 22 ft.
- ◆ Primary load structural system: RC spatial rigid frame System
 - Column grid A (tapered bottom) 42~24 x 26 in.
 - Column grid B & C 18 x 18 in.
 - Beam (taper) 26 x 42 max. in. (transverse frame, grid 1 ~ 4)
 - Beam 16 x 42 in (longitudinal frame, grid A & C)
 - Beam 16 x 20 in (longitudinal frame, grid B)
 - Edge beam 16 x 16 in (longitudinal frame, edges of cantilever canopy)
 - Pre-cast panel (RF) t=8 in.
- ◆ Foundation system:
 - Spread footing F1 9 x 9 x 2.0 ft.
 - Spread footing F2 8 x 8 x 2.0 ft.
 - Spread footing F3 10 x 10 x 2.5 ft.
 - Spread footing F4 7 x 7 x 2.0 ft.
 - + Strip footing 4.5 x 1.5 ft. (Grid 1 & 4)
 - + Strip footing 3.0 x 1.5 ft. (Grid C)
 - + Strip footing 14 x 14 in. (Grid A)
 - + Slab-on-grade t=8 in.
- ◆ Wall: RC t=10 in. for exterior wall
- ◆ Miscellaneous: 1@RC slope 60 x 10 ft. (t=8 in.)

Condition Survey

Concrete patching was found on columns and walls probably due to seismic damage. No other visible building deficiencies were noted during the assessment.

Maintenance and Operational Improvement

The building appears to be acceptable for its current use. However, for such buildings constructed 35+ years ago, a code compliance check (especially seismic design aspects) is strongly recommended.

2.3.13 Description of Miscellaneous Buildings

Location: Cargo Terminal, See Figure 2.3-2.

Port Police Station

This building is occupied by federal government authority US Customs and Border Protection, and is located near the main gate. Hardly any information was received either from site survey or as-built document., However, the building is a reinforced concrete structure from its appearance, and would have been built after 1970.



Electrical Load Centers

Four (4) Load Center buildings (LC) are located inside the Port. LC#1 is located behind the Horizon Lines Building; LC#2 is attached to the east side of Warehouse #1; LC #3 & LC#4 are located in the Container Yard. LC#3 is on the south side near Berth F5 and LC#4 is located against the fence wall at the north boundary.



All these Load Center buildings are reinforced concrete structures, and are relatively new (erected between 2003 & 2004). No noticeable building deficiencies were found in the survey.

Tower

The Control Tower was constructed between 1968~69. It is a 3 story reinforced concrete structure, located at the east side of the CFS building.



The building is 33 ft. in height, with Roof coverage area 31.3 x 31.3 ft. An exterior stair is attached to the north side of building.

The building is supported by strip footing, bearing wall/spandrel beam at 1F & 2F, and column/beam at 3F, and RC Slab/Roof.

Metrics describing the structure include the following.



- ◆ Strip footing 6.5 x 1.5 ft.
- ◆ Wall t=12 in.
- ◆ Column 12 x 12 in.
- ◆ Spandrel Beam 16 x 24 in. (1F & 2F)
- ◆ Beam 30 x 16 in. (3F)
- ◆ Slab t=12 in. (1F & 2F)
- ◆ Roof (tapered) t=13 in. (max.)

Typical sections are extracted from the as-built drawings and included in Appendix 2-2.

Another tower structure is located at the north boundary.

No visible building deficiencies were noted during the survey. Concrete patching was found on columns and walls probably as a result of seismic damage.

Gas Station

Gas Station is located at south side of Port Police Station; based on discussion with Port Staff during the site visit we understand that this building is abandoned.



Sewer Pump House

The Sewer Pump House (SPH) is located at the northern fence-line, near Route #11, and it is isolated by a concrete masonry unit wall / chain-link fence.

The Sewer Pump House was observed to be a single-story reinforced concrete structure. Little information was available to the team either from the site survey or from as-built documents.



2.3.14 Berth F1

Location: Marine Industrial Facilities Area, See Figure 2.3-2.

Wharf F-1



Description & Metrics

Wharf F-1 Dolphin



Berth F-1 is used by Shell for unloading oil tankers and SPPC for LPG. It consists of 6 berthing and mooring dolphins. The dolphins have cast-in-place concrete caps supported on steel pipe piles. Walkways made of steel trusses are used to connect the dolphins together and provide access to the fenders and the mooring hooks.

Condition Survey

Shell has undertaken a major refurbishment project recently to repair the dolphins. This work included the removal of the badly damaged portion of each pile and replacing it with a new steel pipe pile section. Underwater welding was used to connect the new segment to the existing one and a new connection was made to the concrete cap by removing and recasting a portion of the cap at each pile. The upper portion of each pile was also wrapped in Fiberglas sheets to provide extra protection to the piles.

Maintenance and Operational Improvement

The facility is performing its function properly especially after the recent repair of the dolphins. The repair seems to have been done properly. However, regular periodic inspection of the piles both above and below water is important.

2.3.15 Marine Industrial Terminal

Location: See Adjacent Figure.

The Marine Industrial Terminal including the Oil Tank Farm is located in an area to the north-west of the commercial terminal on about 50 Acres of land. Facilities include oil tanks and pipelines (Lot #1/#2/#3/#7, 33 acres), RC warehouses (Lot #4, 4 acres, GEDCA-owned area), RC cement silo (Lot #6 ,



2.3 acres), and light-gauge sheds (Lot #5 , 5.7 acres) scattered inside this land area. This area has been leased to private companies since 1969/1970 as listed below. Very little information about the facilities in this area was received either from the records or the site survey.

Table 2.3-8 Oil Tank Farm Area Tenants

Tenant	Lot No.	Lease Start Date	Area Sq. ft.	Purpose
Mobil Oil Guam	#1	1970/03/20	248,873	Oil Company
South Pacific Petroleum	#2	1969/10/01	217,800	Oil Company
Mobil Oil Guam	#3A	1971/03/04	82,799	Oil Company
South Pacific Petroleum	#3B	1971/01/08	140,002	Oil Company
Guam United Warehouse	#4			GEDCA-owned area
CASAMAR Guam	#5	1970/04/01	223,865	Fish ship/net Repair
Hanson Cement Inc.	#6 Parcel B	1971/01/04	71,773	Cement Supplier
Shell Guam Inc.	#7 F-1 Fingertip	1969/06/13	698,247	Oil Company

2.3.16 Seaplane Ramp

Location: see Figure 2.3-1, Guam Commercial Port Facilities Location Map.

The Seaplane Ramp is located besides the road in the Glass Breakwater area, between the Marine Industrial Terminal and the Golf Pier, and is a very old and abandoned RC waterfront facility. The original use of the Seaplane Ramp is to serve as the landing point for military boats and LVT (Landing Vehicle Tracked). There is no existing utility facility and building, except for two containers and some abandoned container chassis. The existing RC waterfront facility is damaged seriously, and therefore it is suggested that appropriate refurbishment be provided. It is also necessary that it be cleaned consistent with safety considerations. Along the waterfront the facility consists of a shallow retaining sea wall and rip-rapped embankment which is in seriously deteriorated condition.



2.3.17 Golf Pier

Location: see Figure 2.3-1, Guam Commercial Port Facilities Location Map.

The Golf Pier is located besides the road in the Glass Breakwater area, between the Seaplane Ramp and the Hotel Wharf.



The Golf Pier is operated by Mobil Oil Guam under a use and management agreement. The facility consists mainly of a fueling pier with pile supported trestle, dock and dolphins for berthing and securing vessels. Almost all of the current pier structures appeared to be in good condition.

All utility service facilities including electrical, domestic water supply, and sewer within Golf Pier, are maintained by Mobil Oil Guam. Mobil Oil Guam has installed foam fire extinguishing hydrant system at the Gulf Pier, and the fire water is supplied by the main water supply pipe network (mixed with the domestic water supply system) extended from the commercial port area. If the fire water is intermediately pressurized through one fire pump room located in the Marine Industrial Terminal area, the conditions of low pressure or insufficient water flow caused by serious leaks on underground piping are worried.

The Golf Pier is also used by other Port tenants and shippers for unloading LPG and has also been used for unloading cement.

2.3.18 Hotel Wharf

Location: see Figure 2.3-1, Guam Commercial Port Facilities Location Map.

The Hotel Wharf is located besides the road in the Glass Breakwater area, between the Golf Pier and the Family Beach. The wharf consists of an old seawall structure with a new modernized center section.



Most of the newer wharf structure appears to be in good condition except for some damaged older sections areas.



The utility service includes potable water supply. Water leaks and corroded piping was visible. Refurbishment of the system is necessary.

2.3.19 Family Beach

Location: see Figure 2.3-1, Guam Commercial Port Facilities Location Map.

Family Beach is located besides the road in the Glass Breakwater area next to Hotel Wharf. It consists of an area used by the public for family outings, picnics, commercial water-recreational activities other



water related public activities.

Adjacent to Family Beach, Dog Leg Pier exhibits considerable destroyed pier RC structure, which constitutes a hazard for water recreational activities. It is recommended that appropriate demolition and cleanup be performed to avoid risk to users due to these hazards.

Family Beach is now leased to several operators for picnics, jet skiing and swimming. All utility service facilities including electrical, domestic water-supply and sewer within Family Beach are provided and maintained by these operators.

2.3.19 Deep Draft Wharf

The USACE, is in charge of preparing an Environmental Impact Statement (DEIS) for construction of a new 1,500 linear foot deep-draft wharf in the Apra Harbor south of the Glass Breakwater in the area between Hotel Wharf and Outhouse Beach. It has released a draft EIS (DEIS) document at this time. The DEIS shows that the project would also include fill placement to create new land in the vicinity of Seaplane Ramp, Golf Pier and area to the west of the tank farm area. It would create 18.5 acres of new land to support port activity by the beneficial reuse of some 1.5 Million Cubic Yards of material from the U.S. Navy from another project in inner Apra Harbor.

2.4 Commercial Port Area Utilities

A Port-led orientation tour, survey and interviews with various department of PAG and the utilities authority of Guam were conducted in order to obtain the following information and inventory of site utilities at the Port. Findings on the current major site mechanical, electrical, and plumbing (MEP) facilities are listed out on below Table 2.4-1 for easy reference. Details of each system will be discussed on the subsequent section.

Table 2.4-1 List of Major Site Utilities

Equipment Details	Current Capacity	Remarks / Comments	
Container Yard Lighting			
Location: Cargo Terminal, See Figure 2.3-2			
50' Pole			
7 x Lamps	1 Ea.	In general, 1000W Metal Halide Lamps	
6 x Lamps	11 Ea.		
4 x Lamps	7 Ea.		
3 x Lamps	7 Ea.		
2 x Lamps	4 Ea.		
80' Pole			
5 x Lamps	2 Ea.		
4 x Lamps	7 Ea.		
2 x Lamps	1 Ea.		
Electrical Supply			
Location: Commercial Port Area, See Figure 2.3-2			
GPA Supply	2840kVA (13.8kV/ 119A)	Limited by the overhead line supplying PAG. GPA advised that feeder is currently not on the under-frequency load shedding list.	
LC1	Tx. 2000kVA 13.8kVDelta- 480VY/227V		
	Gen. 625kVA 480V/277V	At 45% with 344kva available. With separate oil tank (600Gal) outside LC	
LC2	Tx. 1000kVA 13.8kVDelta- 480VY/227V		
	Gen 344kVA 480V/277V	Almost Full Load. Set mounted oil tank. Will upgrade soon to match with LC1&LC4.	
LC3	Tx. 750kVA 13.8kVDelta- 480VY/227V		
	Gen. 344kVA 480V/277V	Almost Full. Separate oil tank next to Gen. Upgrade soon to match LC1 & LC4.	
LC4	Tx 2000kVA 13.8kVDelta- 480VY/227V		
	Tx 1500kVA 13.8kVDelta- 240V Delta	Supplied by GPA	
	Gen 625kVA 480V/277V	At 55% with 280kva avail. Backup only loads connected to GPA supplied Tx. loads. With separate oil tank (600 Gal) next to Gen.	
Lightning Protection System			
Location: Cargo Terminal, See Figure 2.3-2			
No lightning protection system provided to buildings, cranes or lamp poles.			

Abbreviations: Tx. – Transformer, Gen – Emergency Generator

Table 2.4-1 (Cont.) List of Major Site Utilities

Equipment Details	Current Capacity	Remarks / Comments
Water Supply		
Location: Cargo Terminal, See Figure 2.3-2		
Main Supply Water Pipe from GWA	16 inches	Water pressure is high enough to have direct feed and no pumps required to be installed for water supply. Water outage is about 3 to 4 times per year. Gate valves for the underground water supply systems are, in general, not in good condition.
Fire Services		
Location: Cargo Terminal, See Figure 2.3-2		
Fire Hydrant, Sprinkler and Fire Alarm	Fire Hydrant and Sprinkler systems are direct fed from the GWA water pipe	As the fire hydrant and sprinkler systems are direct fed from the GWA water supply main, there is no water storage tank or fire service pumps installed. Upgrade of the three systems has been completed recently, but As-built drawings are still not yet available. No direct link between the fire alarm system and the local fire station.
Air Conditioning System		
Location: Cargo Terminal, See Figure 2.3-2		
Central A/C system with air-cooled chiller is provided to the Administration Building and some operators (such as Horizon). Other small buildings are in general using either split A/C or window A/C system.		
Sewage System		
Location: Cargo Terminal, See Figure 2.3-2		
Gravity fall system is used and no sewage pumps have been installed. The sewer is fall by gravity to a sewage pump house with the capacity of 150gpm provided by GWA near the main gate.		

Note: This matrix is a compilation of current equipment based on information received.

2.4.1 Electrical Service & Load Center

Location: Commercial Port Area, See Figure 2.3-2

The power supply to the Port is tapped off from the GPA 13.8kV overhead line along Route 11 outside of the port and this overhead line also feeds the other piers and facilities along the road. The line goes underground out from the Piti Substation and turns to the overhead line along Route 11. The line is radial fed and without ring arrangement.

There are two incoming feeders tapped-off the GPA overhead line to feed the primary electrical substations (Load Centers) of the Port. There are four (4) Load Centers namely LC-1 to LC-4 installed in and servicing the whole Port. Each load center has an emergency diesel generator to back up the essential loads.

Incoming Service

PAG is being serviced by GPA distribution feeder P-003 from Piti Substation with a radial fed 13.8kV line routed through underground system from PITI Substation to the GPA Cabras Facility then to an overhead system, which the PAG tapped power from. The underground system consists of 3#500 XLPE Primary wire which has an amperage capacity of 472 amps and the overhead system consist of 2#2/OA1 and 1#2AI primary wire which has an amperage capacity of 119 amps. P-003 is being fed from GPA substation transformer T-7, which has a load limit rated at 10.5MVA. Currently the GPA feeder P-003 is



not on the Under-frequency Load Shedding List. See Figure 2.4-1 for the schematic diagram provided by GPA for details.

The first tapped off location from the PGA overhead line is at GPA Pole no. PM-2-59 adjacent to the Administration Building via underground ducts to LC-1 and further supplies LC-2 and LC-3 via underground duct system.

The second tapped off location is at the 11th pole counting back (i.e. toward Piti Substation) from Pole no. PM-2-59 and feeding LC-4 near the reefer stalls.

Both kWhr meter and kVar meter is installed in LC-1. In LC-4, the circuit feeding the 13.8kV-240V power transformer is provided with both kWhr meter and kVar meter, while circuit feeding the 13.8kV-480V power transformer is provided with kWhr meter only.

Switchgear – Primary Distribution

Load Center LC-1 is fed from a GPA 600amp, 13.8kV, 15kV manual switchgear and then connected to one un-fused incoming disconnect switch and three fused disconnect switches with one feeding LC-1 distribution transformers and the other two switches feeding LC-2 & LC-3.

Load Center LC-2 contains of one fused disconnect switch.

Load Center LC-3 contains of one fused disconnect switch.

Load Center LC-4 is fed from a GPA 600amp, 13.8kV, 15kV manual switchgear.

Figure 2.4-1 GPA Power Supply Schematic for PAG

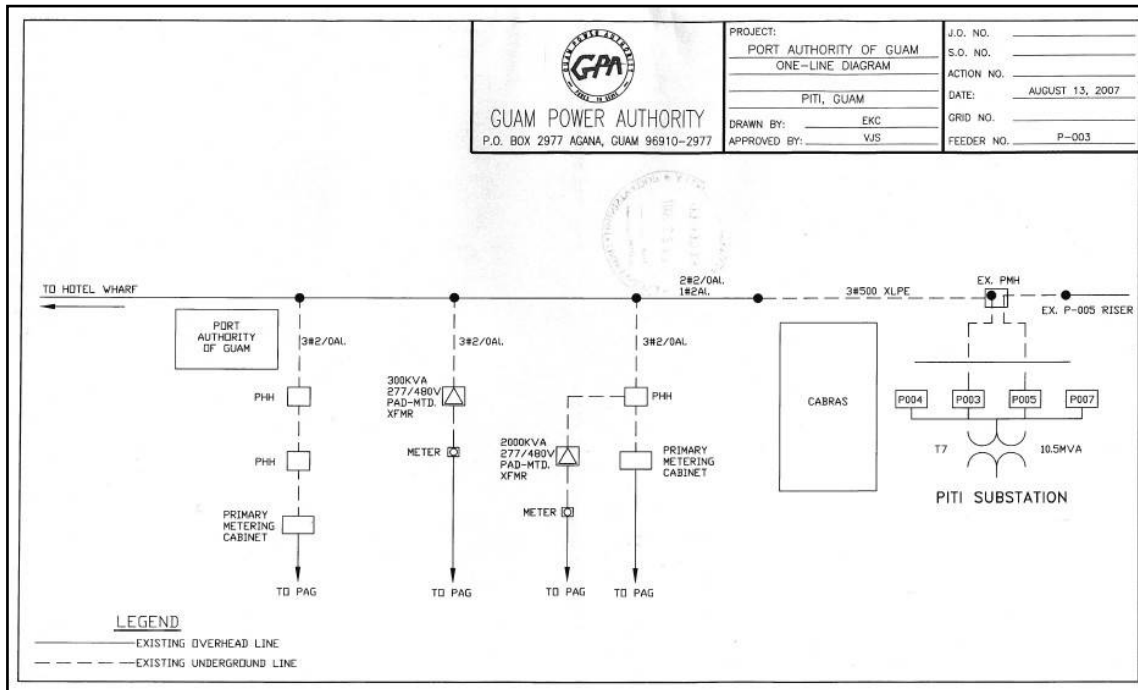

Switchgear – Secondary Distribution

Load Center LC-1 secondary distribution switchgear contains one 1200 amp 480Y/227 volt distribution panel completed with one 4 Pole 1200 amp ATS for the connection of emergency generator. LC-1 in general supplies power to the Administration Building and the vicinity areas including the Port Police Building, Horizon Lines Building, parking lightings, etc.



Load Center LC-2 secondary distribution switchgear contains of one 1200 amp 480Y/227 volt distribution panel completed with one 4 Pole 1200 amp ATS for the connection of emergency generator. LC-2 in general supplies power to Warehouses 1 & 2 and the vicinity areas including the services outlets along F-3 and F-4.

Load Center LC-3 secondary distribution switchgear contains one 1200 amp 480Y/227 volt distribution panel completed with one 4 Pole 1200 amp ATS for the connection of emergency generator. LC-3 in general supplying power to CFS Building and the vicinity areas including the services outlets along F-5 & F-6 and the container yard lighting.

Load Center L4 secondary distribution switchgear contains one 2000 amp 480Y/227 volt distribution panel completed with one 4 Pole 2000 amp ATS for the connection of emergency generator and one 3000 amp 240 volt distribution panel. LC-4 in general supplies power to Check Point Building and the vicinity areas including the reefer outlets, container yard lightings nearby LC-4 and Check Point Building.

Transformers

The transformers in the Load Centers are as follows:

- LC-1 – one 2000kVA, 13.8kV Delta-480Y/227 volt
- LC-2 - one 1000kVA, 13.8kV Delta-480Y/227 volt
- LC-3 - one 750kVA, 13.8kV Delta-480Y/227 volt
- LC-4 - one 2000kVA, 13.8kV Delta-480Y/227 volt and one 1500kVA, Delta/Delta 13.8kV/240 volt.

Emergency Generators

Emergency diesel generators are installed in each Load Center to back up and maintain the essential service in each Load Center. The details of the generators in the Load Centers are as follows:

- LC-1 – one 625kVA, 480/227 volt, with one separate diesel oil tank (600 Gal) outside LC-1.
- LC-2 - one 344kVA, 480/227 volt, with one set integral diesel oil tank.
- LC-3 - one 344kVA, 480/227 volt, with one separate diesel oil tank in LC-3.
- LC-4 - one 625kVA, 480/227 volt, with one separate diesel oil tank (600 Gal) in LC-4.

Condition & Maintenance Issues

The equipment reviewed in the field for Load Centers LC-1, LC-4 was relatively new and appeared to be in physically good condition. According to Port maintenance staff the Load Centers LC-1 & LC-4 have undergone major upgrades recently (2003). However, the equipment in LC-2, LC-3 was relatively old and appeared to have deteriorated with age. According to Port maintenance staff, there is a plan to replace all the main circuit breakers and power panels in year 2008 and a major upgrade of LC-2 & LC-3 to match with the capacity of LC-1 and LC-4 would be undertaken soon. The Port maintenance staff also mentioned that major underground cables were replaced 2 years ago and hence the cables should still be in pretty good condition.

Existing Energy Demands

Without the power bills and no maximum demand indicator installed on the main power panels, there are no firm details on the energy demands data available. However, as advised by the Port maintenance staff, the current loading on LC-1 and LC-4 is about 45% and 55% respectively. However, the Load Centers LC-2 and LC-3 are almost fully loaded and that was also the reason for having a plan to upgrade LC-2 and LC-3 to match with the capacity of LC-1 and LC-4 soon.

Future Capacity for Expansion

With the upgrade of LC-2 and LC-4 to match with the capacity of LC-1 and LC-4, a substantial amount of spare capacity in the secondary distribution voltage level (i.e. 480/227 Volt) should be available. However, as advised by GPA, the overhead line feeding the Port along Route 11 would have the current capacity of 119A at 13.8kV. Converting to kVA, the maximum capacity would be limited to 2840kVA, which is much less than the sum of the current installed capacity of the distribution transformers

(7250kVA). Should major expansion in electrical demand occur in the future; additional feeders from GPA will be required.

2.4.2 Storm Water Drainage System

Location: Cargo Terminal, See Figure 2.3-2

Gravity drainage system consists of underground pipes (12~30 in. diameter RCP), sump pits and surface drain channels (D36in. x W34in.) which are provided to collect the storm water and directly discharge to the sea without using pumps or passing through oil water separator. There are two numbers of outfalls in F-3, four numbers between F-4 to F-6 and two numbers at the Cabras Island areas.

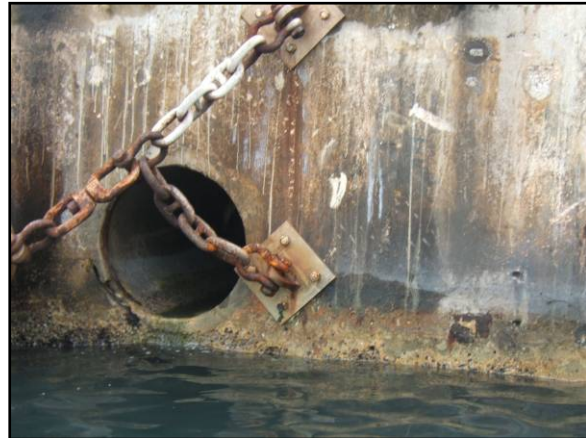

2.4.3 Sanitary Sewer System

Location: Commercial Port Area, See Figure 2.3-2

The Port is currently served by a gravity sewer system which consists of underground pipes (-2 to -11 ft. from grade elevation) and sump pits. The sewage is collected at the central lift station (pump house) provided by GWA, which is located near the main gate. The GWA lift station pumps sewage to the gravity line in Marine Drive which flows to the Hagatna Treatment Plant. The existing GWA lift station system is designed for a capacity of 150gpm. Based on our conversation with the Port maintenance staff blockage of the sewage is very rare. There were two times blockage was caused by someone flushing their underwear down the sewage system.

2.4.4 Domestic Water System

Location: Commercial Port Area, See Figure 2.3-2

There is one 16 inch main water supply pipe from GWA located at the eastern end of the Port to provide water supply for the Port and distribute the water with underground pipes toward the west side of the Port. After the main water meter chamber, a 12 inch pipe is tapped off from the 16 inch pipe to supply the Hotel Wharf and other Tenants outside the Commercial Port. Another 12 inch pipe is also tapped off from the 16 inch pipe and routed through the parking areas in front of Administration Building to supply the Shell pier.

Hydrants and water supplies to other areas, buildings and water service pits within the Port are tapped off from the 16 inch pipe. As the pipe distribution network routes to the west end of the Port, the main underground pipes are reducing from 16 inches, to 12 inches and then down to 10 inches.

According to Port staff, the water pressure throughout the Port is good with no need to install booster pumps. There has been some water leakage from the underground water pipes. Whenever this has occurred, the Port maintenance team has assigned a water leakage detecting company to find the fault location and have it repaired. However the following concerns have been raised by the Maintenance team and should be considered by the Port to address:-

- As a large portion of the water supply pipe serving Shell is routed inside the Port (some of them are under the container stacking areas). Any maintenance works for the pipe would need to be carried out within the Port areas and may interrupt the Port operation. In order to avoid unnecessary interruption to the Port operation, relocation of the pipe outside the Port area should be considered.
- As advised by the Port staff, currently there is a water outage from GWA 3 to 4 times every year. As the fire and potable water supplies are mixed and direct-fed from the water supply line without any storage tank or pump, water outages from GWA affect both the domestic water and fire water systems. In order to preserve some measure of fire-fighting capability in the face of a water outage, a water storage tank should be installed.
- Port maintenance staff has stated that the gate valves for the underground water pipes are not in good condition. Only three valves have been replaced so far from the first installation of the underground water pipe system which dates back several years ago. Sometimes water leakage in one section of the pipe may require the shutting off of more than one valve to stop the leakage. A re-arrangement of the valves should be considered to provide zoning of the water supply to ease future maintenance works.
- As advised by the Port maintenance staff, some of the underground water pipes are still using asbestos which is a concern for the quality of the water supply. A more detailed survey should be carried out to remove and replace those pipes.

2.4.5 Yard Lighting

Location: Cargo Terminal, See Figure 2.3-2

50 and 80 foot high pole-mounted flood lights with 1000W metal halide lamps are installed to light up the majority of the container yard. There are thirty 50-foot poles and ten 80-foot poles to serve the yard areas. The numbers and configuration of the flood lights of each pole are different to suit the location. See Table 2.4-1 Current Major MEP Facilities List for details.

Should major expansion to the container yard be required, including the increase of stacking height of the containers, the pole-mounted yard lighting may need to be raised. High mast lightings or light towers should be considered as a better alternative to pole mounted light fittings. This would allow much more flexibility (coverage per high mast or light tower can be much wider) on laying out the lights to suit the efficient operation of the yard and would also be easier to maintain.



2.4.6 Fire Protection System

Location: Commercial Port Area, See Figure 2.3-2

Fire hydrants and sprinklers are directly tapped off from the main water supply pipe network (mixed with the domestic water supply system) within the port, without providing pumps or storage tanks.





The current water pressure from the water pipes is high enough to serve the use. However as mentioned in Section 2.4-4 above, in order to increase the supply security, water storage tanks should be considered.

Hoses are not currently in place adjacent to the fire hydrants. This lack of fire hoses is a concern that must be addressed by the Port.

There is no direct link between the port fire alarm systems and the local fire station. A Fire alarm raised in the port would need to be reported to fire station by telephone. The closest fire station is 3 minutes away from the Port.

As advised by Port maintenance staff, upgrade of the fire hydrant, sprinkler and fire alarm systems has been completed recently. During implementation of terminal modernization the entire fire system should be assessed and upgraded as needed to support the new terminal operations and facilities. This should include evaluation of underground storage tanks and seawater backup fire fighting systems as appropriate in conjunction with the relevant fire fighting agencies. It is also recommended that fire fighting personnel be trained to handle shipboard fires.

2.4.7 Other Building Services

Location: Cargo Terminal, See Figure 2.3-2

No lightning protection devices have been found in the buildings, lamp poles or cranes to protect the Port facilities. Suitable lightning protection devices should be considered to protect the Port facilities and the operators.

Central A/C system with air-cooled chiller is provided to the Administration Building and some operators (such as Horizon). Other small buildings are in general using either split A/C or window A/C systems. This combination of equipment is considered suitable for the current facilities layout and avoids the need to run extensive services underground to serve isolated small buildings.

2.5 Operating Environment

The consultant reviewed the operational environment at the Port and commercial cargo terminals. The following is description of our findings based on location, activity, equipment or feature listed.

2.5.1 Navigation Environment

Apra Harbor enjoys an existing breakwater and sheltered harbor with deepwater anchorages and access channels as described in Section 2.2. The following Figure depicts the number of vessels that have used the harbor

Figure 2.5-1 Historical Ship Traffic in Apra Harbor

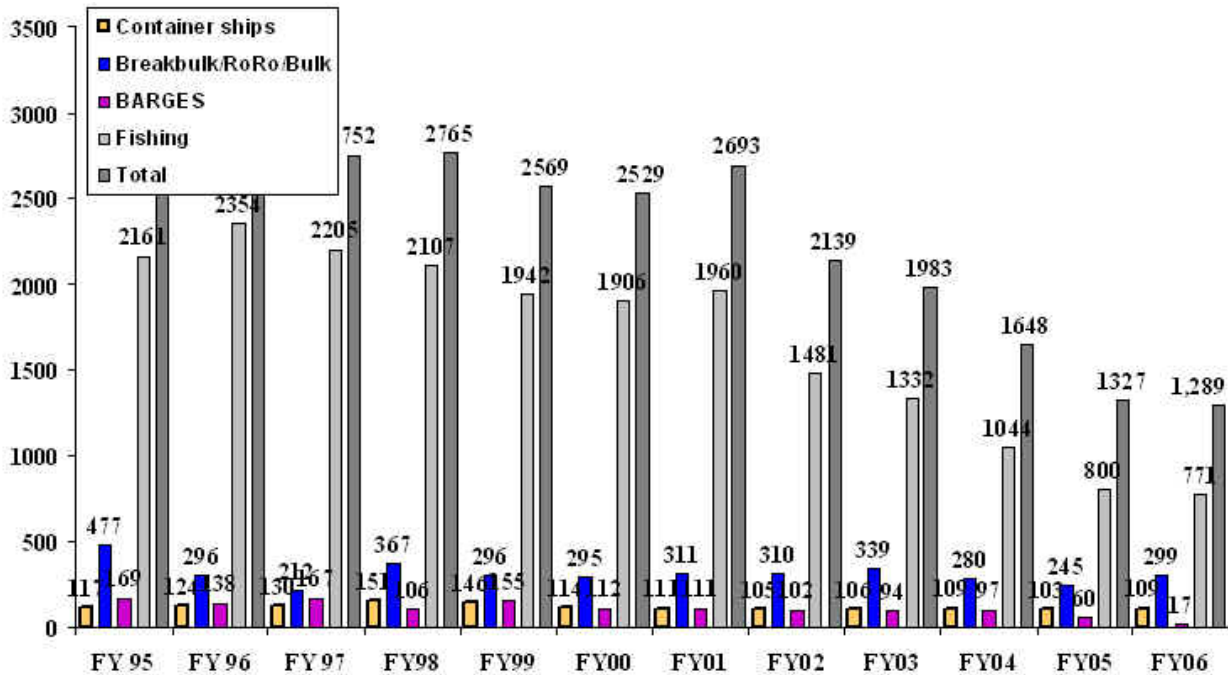

Source: Port Authority of Guam

The number of total ship calls has steadily decreased over the years from 2,824 in 1995 to 1,196 in 2006. These figures do not include military vessels. The categories are summarized in Table 2.5-1.

Table 2.5-1 Historical Vessel Calls

Type	1995	2006
Container Vessels	117	109
Break-bulk, Ro/Ro & Bulk	477	299
Barges	69	17
Total Commercial	663	425
Fishing Vessels	2161	771
Total All Vessels	2824	1196

Source: Port Authority of Guam & PB

As discussed previously Fishing Vessels general require pilotage only the first time in harbor for orientation. After that these vessels navigate in and out without pilotage or tug assist. The commercial vessels (all assumed to be over 500 GRT) do require pilotage and tug assist. They have declined from a total of 663 to 425 over the years listed.

Assuming a channel occupancy time of 1 hour each way, we estimate channel occupancy has declined from 6% to 5% for commercial vessels. Even after allowing for Military Vessels, Priority Vessels such as Aircraft Carriers and weather interruptions the harbor does seem to have significant capacity for more commercial vessel traffic if needed.

2.5.2 Port of Guam Advantages

The Port has a number of additional advantages which are not enjoyed by other similar aging commercial ports. As discussed in Section 2.1.3 under Land Use, the commercial Port area is largely in an isolated industrial zone. There is virtually no urban encroachment to be seen around the port area.



The Cargo Terminal does have land and waterfront for expansion to the east of the existing terminal area over the 20 year planning horizon. As discussed in Section 4.1.1, PAG enjoys carrier services from the U.S. Mainland as well as service from Asia. Both Matson and Horizon Lines call at PAG on their rotation from the U.S. West Coast through Honolulu to ports in China. In addition the Kyowa and MEL line service provides cyclical access to points in Asia.

PAG had always been a transshipment hub for cargo moving to CNMI. Recently PAG has also become a hub for transshipment service to other Micronesian Islands through Matson's Islander Service.

With a steady environment of cargo flow over the years PAG has established an operating record as a Port at its current location albeit at outdated facilities that must be modernized. This track record of usage at existing berths and the terminal facilities is often considered an asset compared to construction of a green-fields port, especially with respect to the environment and obtaining Federal permits.

2.5.1 Container & Break Bulk Cargo

Location: Cargo Terminal, See Figure 2.3-2.

2.5.2 Berth Service

Insufficient Berth Depths: The berth depths at F-4 through F-6 are insufficient to fully utilize the cargo carrying capacities of the larger vessels calling at the Commercial Cargo Terminal. The current design depths at these berths are at -34' with a design depth of -37.5' at the section of F-5/F-6 which was rebuilt in 1998 after the 1993 earthquake damage. Table 2.5-2 presents parameters including drafts for some of the representative vessels calling at Cargo Terminal.

Table 2.5-2 Parameters - Representative Current Ships Calling at PAG

Line	Ship	DWT	Type	LOA	Beam	Draft
MSA	ASIAN HIBISCUS	8,004	Ro-Ro	387	61.7	24.1
CTS	HANEBURG	11,108	Container Ship	447	68.9	27.9
Horizon	HORIZON HUNTER	28,592	Container Ship	729	98.4	39.4
Horizon	HORIZON PACIFIC	30,903	Container Ship	813	90.0	33.0
Matson	ISLANDER MATSON	6,837	Container Barge	372	66.0	16.5
MSA	KYOWA SALVIA	8,038	Ro-Ro	387	63.0	24.1
Matson	MANUKAI	38,261	Container Ship	712	105.6	41.0
Matson	MAUNAWILI	38,261	Container Ship	712	105.6	41.0
CTS	SYLVETTE	10,734	Container Ship	426	72.5	27.3

Source: Sea-web and Port Records

It is apparent that the Matson Vessels class of vessels recently put into service and the Horizon Hunter have drafts exceeding the berth depths when the ships are fully laden. While these large container liner service vessels from the US West Coast are normally transporting a significant number of empty containers, they still must light load below design draft in order to obtain service at PAG.

Berth Service Patterns: It is important to understand the typical berth service and rotation patterns in order to assess port capacities. For example, some ports may have very large vessels call at adjacent windows during certain days of the week with relatively less demand for service at other times. This may show a low utilization for the week but taxes berth service for the days when lined vessels must obtain service. This was the pattern at PAG.

Figure 2.5-2 Typical Weekly Service Demand Patterns

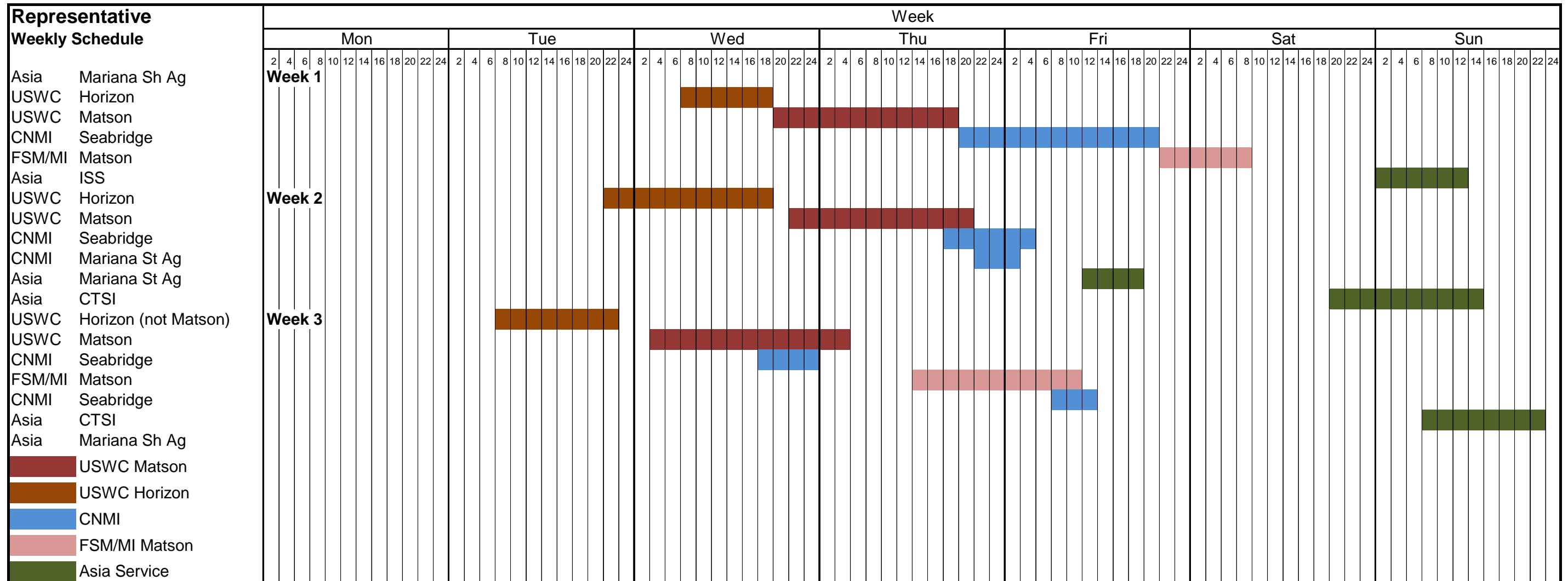

Source: Port Authority Ship Logs

NOTE: The representative schedule shown above was formulated on the basis of ship operations data extracted from the Port's computer system at commencement of work on the master plan study. Since then the shipping schedules for both Horizon and Matson have changed with their USWC ships arriving on Monday and Tuesday respectively. This change does not materially affect the analysis and recommendations presented in this report.



Figure 2.5-2 presents the berth service time for the ships that were provided service during three consecutive weeks in May 2007.

- Horizon and Matson are serviced back to back at the beginning of the week.
- The CNMI transshipment service starts at the tail end (with some overlap) of the Matson service.
- The Matson Islander transshipment service to FSM, Marshall Islands etc. is every other week and starts after the departure of the Matson ship from the USWC.
- Asian Service takes place during the latter part of the week.

Note that this is partly driven by the nature of the business (cargo movement logistics) between the USWC China Service and the Transshipment Services that feed off of these. Peak service demand for the cranes and the yard occur during the two days when the USWC service vessels are in port.

Berth Occupancy: During the above month of May the Berth Occupancy for F-4 through F-6 were as shown in Figure 2.5-3. Note that this is occupancy while a vessel was docked for cargo service and does not include lay berth occupancy since when demand increases lay berthing the service dock would not be feasible.

Figure 2.5-3 Representative Berth Occupancy (May 2007)

Berth	F-4	F-5	F-6
Occupancy for Service	17%	42%	5%

Note that berth occupancy for F-5, which was the preferred berth for container cargo service was 42%. Note that the USWC vessels are longer (712' to 813') than the typical berth length of 660'. Allowing for lines and separation distance of say 100' at each end a USWC vessel that is moored at F-5 would encroach about a quarter of the berth length into F-4. This limits the LOA (length overall) of vessel that can be accommodated at F-4. If the computation was performed on the basis that F-4 is tied up for these larger vessels moored at F-5, the Berth Occupancy in Table 2.5-3 for F-4 increases to 48%.

Crane Service: Description and metrics on the existing cranes at the Cargo Terminal are presented in Section 2.3.3. This section described the poor condition of one of the two cranes that are currently operational. In addition to the condition, there are a number of operational issues that result in berth service rates below compared to that of similar more modern terminals.

- Crane Lifts / Gross Time at Berth for the larger USWC container vessels was computed at 15 per hour for the Utilizations period in Figure 2.5-3. Gross time at berth for this is defined from vessel tie-up to cast-off. A comparable figure for a USWC port with modern single-lift cranes is about 25 lifts/hour. Some terminals world-wide achieve rates above 40 lifts/hour.
- The height under the spreader on the cranes only permits servicing on-deck containers three high where as the newer USWC ships are designed to stack containers seven high on deck. These vessels are forced to pre-plan to bring in reduced deck cargo bound for Guam.
- Crane 2 is capable of reaching 13 boxes wide on the vessel (PANAMAX Class).

These service constraints need to be eliminated. Note that neither crane is capable of servicing the newer Post-PANAMAX class of vessels that can store containers from 16 boxes wide to 22 boxes wide for the largest vessels in service.

Storage Yard Operation: The PAG Cargo Terminal for container cargo operates in a hybrid "Wheeled" and "Grounded" mode that may be described as follows.

- Incoming USWC containers are placed directly onto road chassis coming off the ship. Matson and Horizon provide their own trailers. The Container and Chassis are stored in the yard until the consignee's trucker come to pick up the container. This "Wheeled" operation does require more yard area than a denser stacked system. However it eliminates the need for a second lift by yard equipment necessary if the container was grounded.



- Transshipment and Asian service containers are placed off the ship to Yard Tractor/Trailers and moved to the container yard. Yard equipment such as the Top-Pick or the RTG removes the container and stacks it in the yard until the trucker arrives with a chassis for pickup.
- Empty Containers are also grounded and handled with Empty Handlers.
- PAG has a differential rate with a higher throughput charge for grounded containers.

The container yard is available for pick-up or delivery on week-days for eight hours of the day excluding a one-hour shutdown for lunch. Users and stakeholder raised concerns about the ready availability of chassis when needed. The Asian service carriers expressed concerns over the lack of availability of dependable yard equipment that can handle their grounded cargo in an efficient fashion. The two RTG's are obsolete and are inefficient. There was no detailed information available for operations within the yard and therefore a detailed analysis of the yard was not feasible. However, considering the type of operation, we estimate that the yard area is insufficient to support significant increases in cargo throughput. This would especially apply to the Wheeled Cargo. PAG has recognized this and has expanded the number of wheeled slots. It is in the process of expanding the number of Reefer cargo slots to 160. It has also expanded the paved area to support neo-bulk cargo such as automobiles outside the container area and make more slots available for containers.

Truck Gates: The truck gates which were constructed in the 1990-1991 timeframe with two queuing lanes in each direction are physically newer than the remainder of the terminal. However, the design and operation need improvement. Some of the constraints include the following.

- Trucks are stopped and manually processed first at the Guardhouse or Entrance Gate on Route 11. Incoming empty containers are opened and checked at the Guardhouse.
- The Truck Gates are oriented in a fashion that makes it awkward for queuing. Trucks must make a left turn from Route 11 directly into the gate lanes with insufficient length for scanning functions or queuing.
- There is no electronic cargo tracking. The computer system in the terminal is not capable of exchanging information with the shipper's (EDI) operating system. The terminal uses a paper based system for processing the trucks through the gate. Containers are manually inspected and seals checked at the gate. This makes processing of trucks slow.

Terminal Operating System: There is no recognized, modern terminal operating system (NAVIS, RBS and Total Softbank etc.) available at the terminal. The terminal uses a customized flat file system on an AS400 developed several years ago to keep track of terminal operating information. The Consultant team after much effort was able to obtain port information on ship service logs from the system. However, the data was in a form which required several weeks of clean-up effort to condense into a usable form for some of the analyses in this report. There was no information available on tracking containers within the yard or through the gates. The terminal system is therefore not capable of interfacing with the cargo information from the shipping lines in order to perform ordinary functions such as pre-processing of incoming trucks, pre-stow for vessels etc.

Mix of Terminal Activities; The Cargo Terminal has mix of various activities. Some are related to cargo movement while others such as servicing of fishing vessels and passenger vessels are not. Also certain functions that in other modern terminals are moved offsite are still within the port area. For example, these activities include container and chassis repair, container stuffing and stripping and steamship line office space and other activities not directly related to ongoing daily commercial cargo operations. These types of activities are more typically moved outside of the secured area but still within or in close proximity to the general port area.

Distribution of Labor to Meet Peak Demand: In addition to the outdated equipment, one of the common concerns raised by stakeholders was the insufficient distribution of labor to meet peak operating periods. Figure 2.5-2 confirms that weekly activity at the terminal is concentrated over a few days with peak occurring such as before and after the larger USWC vessels arrive. Back to back shifts are needed for crane service to match up to the back to back arrivals of Horizon and Matson ships. On the gate side,



it would be normal for incoming truck traffic to peak with more containers coming into the terminal prior to arrival of these vessels. Similarly, outgoing truck traffic will peak just after vessel departure. The stakeholders concerned about system of distribution of labor and the availability of labor to support these peak operating periods are the shipping lines and their agents.

2.5.2 Fishing Industry Operations

Location: Cargo Terminal & Marine Industrial Facilities Area, See Figure 2.3-2.

Fishing industry marine activities at the Port include Purseiner Fishing Boat repair and Long-liner operations. As shown in Figure 2.5-1, total fishing fleet activity in Guam has declined considerably from 2,161 in 1995 to 771 vessel calls in 2006.

Purseiner Repair Facility Operations

These operations are conducted exclusively by CASAMAR whose facility as described previously is located at F-2. They currently do repair on 250 to 270 boats a year in addition to repair of fishing nets. CASAMAR has long term lease passed on to the Port through GEDCA with some 40 year remaining. They have no intention of moving from these facilities. The draft at F-2 is about 24' to 26' and CASMAR would like to increase it to 30' in the future.

The CASAMAR facility access and lease area activities are separated from the Terminal access gate and upland activities. Therefore, unlike the Long-liner Fishing Industry activities, this operation has no significant impact on terminal activities.

Long-liner Fishing Industry Operations

The Long-liners currently operate out of Warehouse Sheds #1 and #2. The Fishing Boats that they serve use F-3 which is located close to these Warehouses. Their operation is currently within the terminal area.

The long-liners use 75' to 100' boats with drafts of 15' to 20'. They bring in higher grade Tuna to F-3 for processing at their leased facilities in WH-1 and WH-2. One of the operators has invested cold storage facilities in WH-2.

Berth space at F-3 is tight due at peak conditions and sometimes the boats must double berth its vessels. Catch sizes vary normally from 5 Ton to 35 Tons but could reach as high as 50 Tons. It takes about 3 to 5 hours to offload. The prime portions are packed in ice and air freighted to Japan. The non-prime portions are transferred to the adjacent Port tenant operation at United Fisheries and processed for local consumption.

2.5.3 Cruise Vessels & Passenger Traffic

Location: Cargo Terminal, See Figure 2.3-2.

Guam has received around 6 to 8 calls per year on average in the recent past with approximately 600 passengers per call. The current vessels range in length from 400 to 800 feet and carry between 350 and 950 passengers. The vessels stay a partial day in Guam (i.e., arrive 8am and depart 6pm).

The vessels are berthed either at F-3 or F-4 depending on availability. Since access to these facilities are through the Cargo Terminal, cruise vessel arrivals impact cargo and fishing vessel operations. Sometimes cargo operations have been halted during Cruise Vessel calls due to safety and security considerations. There are no separate facilities available for customs, scanning and processing of visitors.

2.5.4 Cement Unloading

Location: Marine Industrial Facilities Area, See Figure 2.3-2.

Port tenant Hanson Cement, Inc. leases and operates the Cement Unloading terminal at the Port located in the Marine Industrial Facilities Area. There are some imports of cement in super bags through the



cargo terminal, but this is incidental. Virtually all of the some 100,000t of cement that was used in Guam in 2007 was imported through the Hanson facility.

Hanson has used a floating barge adjacent to an existing seawall to facilitate berthing in somewhat deeper water and provide berthing for its Cement Ships. Vessels using the facility range from 4,186 GRT to 10,186 GRT dedicated cement carriers. The draft at the unloading terminal is shallow at 10 feet. The larger vessels must light load in order to get to the unloading point. The supplier currently uses ship rotation and cement supply to other ports in order to bring in smaller loads with ship access to the dock. Average loads are estimated to range between 3,000 to 5,000 MT with a ship every other week. The Cement is aerated and pumped from the vessel into an adjacent silo. Hanson has requested the Port to dredge the berth in order to bring in deeper draft vessels with more cargo. However the feasibility of this option needs to be confirmed due to the proximity of the seawall and its foundation.

Another limitation at the Cement Facility is the single 9,000t silo. Discussions with current base construction contractors indicated that they had to stop construction activities five times in 2007 because of a lack of cement availability. In addition some forms of construction require different types of cement. This is difficult to achieve with only one silo.

2.5.7 Port Security

CONFIDENTIAL INFORMATION
NOT INCLUDED IN PUBLIC REPORT

CONFIDENTIAL INFORMATION
NOT INCLUDED IN PUBLIC REPORT

2.6 Marinas

The location of the Agana and Agat marinas are shown on Figure 1.3-1.

2.6.1 Gregorio D. Perez Marina



Description/Metrics

The Gregorio D. Perez Marina (also known as Agana Boat Basin, Hagatna Marina,) is located in the village of Hagatna and is the marina nearest to Guam's downtown center. The marina basin was originally constructed prior to World War II and consists of two lagoons. Several breakwaters provide protection from offshore waves and swells as well as additional protection for the marina floats within the South Basin.

The marina and basin was constructed by the Corps of Engineers in 1977 under authority of Section 107 of the Rivers and Harbors Act of 1960. It consists of an entrance channel 860 feet long, 120 feet wide, 12 to 15 feet deep; a 1.2 acre turning basin 12 feet deep; main access channel 540 feet long, 80 feet wide, 10 feet deep; a revetted mole 1,135 feet long, an east breakwater 200 feet long, a west breakwater



525 feet long; a 250 foot long wave absorber; three circulation channels; and navigation aids. The lagoon (Agana Marina North) contains floating slips and moorings and has a total capacity of about 122 boats.

Gregorio D. Perez Marina South consists of an East and West Basin separated by a fill area that provides parking and also holds the Harbor Patrol Offices and restroom facility. The East and West Basins contain marina floats for approximately 45 recreational, charter and public agency (fire and police department, Port of Guam) boats. There are two boat ramps in the West Basin. The fueling facility (not operated by the Port) is in the East Basin.

Public Law No. 17 – 071 transferred authority of Guam's public harbors, small boat marinas and facilities from the Department of Parks and Recreation to the Port Authority of Guam. The language in the Public Law stated that the Port of Guam has expertise in the area of managing harbors, ship docking, and implementing harbor safety as evidenced by its success at the commercial port. It also stated that the Port is financially able to take on additional responsibilities in the development of marine resources. Since that transfer, the Port of Guam has been providing financial support for the facility.

Condition Survey

The marina is in extremely poor condition and in some areas unsafe for pedestrian access. A sign near the gangway to the east basin marina floats states "Caution: Unsafe Conditions, Enter at Your Own Risk". Yet these are the floats that tourists must walk on daily to get to their tour, dive and excursion boats. The timber floats are rotted and in many places have plywood covering the rotted deck so that a person doesn't fall through. Some of the plywood coverings are also rotted and in need of replacement. The floats are waterlogged and some are listing. Rub strips are torn or missing. Concrete filled steel pipe guide piles are used to secure the floats in position and appear to be in good condition, however it has been reported that they are not tall enough to keep the floats from rising above the top and coming loose in the event of a typhoon surge. Concrete caps supporting railing posts in some areas around the marina basins have cracked and no longer provide the railing with sound attachment points, resulting in safety problems. Sections of concrete cap over the steel bulkhead have cracked and broken off, exposing steel rebar. Significant corrosion of the steel sheet pile walls is exhibited with gaping holes that permit backfill to escape into the basin. Concrete bulkheads are in poor condition. Some areas of the marina and channel need dredging and it has been reported that there is a rock in the bottom of the West Basin that you can hit with your boat when the tides are very low.

The marina is overcrowded due to high demand and there is little hope of getting a slip even if you are on the waiting list due to the low turnover and method of allocating vacancies. The restroom facility is in poor condition and not adequately maintained. Lighting is poor and tenants have been known to replace light bulbs due to poor maintenance. Security is virtually nonexistent with gates in poor condition or that don't lock. Even if the gates were functional there is little to prevent a person from getting around the gate. Major rehabilitation or replacement is required to get these marina basins into safe and serviceable condition.

Two concrete boat ramps serve the West Basin. The newer one nearest the highway is used by recreational boaters with smaller trailerable boats. The ramp has no boarding float so boats dropped off in the water have no choice but to temporarily tie up to leased slips, someone else's boat or the concrete bulkhead. There is a rinse down station at the staging area. There is inadequate amount of trailerable parking area for boaters using the facility. Some boaters park their trailers in unauthorized area and create operational problems for others. A second concrete ramp in the West Basin serves larger trailerable boats as well as large boats that are being pulled out for inspection or minor maintenance. Boats on blocks are temporarily stored on the inner wall breakwater. This ramp also has no boarding float.



There is a fueling facility in the East Basin. While the fueling facility does not belong to the Port, the bulkhead that the boats tie up to does belong to the Port. Boaters desiring fuel must tie up to the bulkhead and climb a ladder to get to the pumps. Earlier drawings of the site show a fueling float in that location however there is not one currently there. There is a storm-water outfall in the corner of the East Basin.

Maintenance and Operational Improvement

Based upon the condition of the marinas and the basin, very little maintenance has been and currently is being done. Very low marina rates are cited as one of the reasons for this lack of maintenance. There is currently a proposal in the works to revise some of the marina rules, regulations and lease rates. The rates being proposed are still lower than market rates given the demand for slip leases in a basin whose location is so close to the downtown and tourist core. Unfortunately tenants don't want to pay market rates for a deteriorated facility. The result is a Catch 22 where nothing changes and the marina continues to deteriorate.

The basin and channel needs dredging, the floats need replacing, and the bulkheads around the entire basin need to be replaced. These are not inexpensive fixes. A significant financial investment must be made to realize the potential and opportunities this marina provides. Finding the funding will be challenging because increasing the slip rates alone will not be sufficient to pay for the improvements. Without a financial investment, the best one can hope for is to maintain a marginally safe facility that will continue to deteriorate.

The Port Authority of Guam has been awarded a Department of Interior (DOI) grant for major renovations at the GDP Marina, in addition it has entered into a memorandum of understanding with the Division of Aquatic and Wildlife Resources for minor maintenance and upkeep of the marinas.)

At a minimum, safety repairs should be made, including providing safe walking surfaces for tourists and tenants on the floats, safety rail repairs, security improvements that include lockable gates and lighting, and providing a float at the fueling facility. Better maintenance of and operational control (access rights) to the restroom facility should also be provided. As a condition of tenancy, the police department should engage in increased random security patrols of the site to assist the Port with the security problem.

The navigation aids at Agana Marina are in place. It has been reported that the lights on the entrance beacons frequently go out. There are two range towers on shore that identify the channel into the marina.

2.6.2 Agat Marina

Description & Metrics

Located in the village of Agat on the west coast of Guam near Gaan Point, is Agat Marina. It is a small boat harbor (often called Agat Small Boat Harbor) that was excavated from a coral reef flat and is protected by a detached breakwater. The boat harbor basin construction was completed in 1989 with contributions from the US Army Corps of Engineers and the Port Authority of Guam. Shoreside facilities were completed in 1990.

The Corps of Engineers describes the site as follows: "The project consists of an entrance channel 930 feet long, 120 feet wide, 14 feet deep; a turning basin 120 feet long, 150 feet wide, 7 to 11 feet deep; a main access channel 500 feet long, 75 feet wide, 9 feet deep; two breakwaters 985 feet long and 50 feet long, respectively; and two revetted moles 180 feet long and 300 feet long. The protected basin provides berthing areas for up to 150 boats."



The marina consists of slips for 114 boats broken down as follows:

- 25 foot slips - 72
- 40 foot slips – 32
- 60 foot slips - 10

The floats are manufactured by Meeco and are constructed of timber decking and whalers, polyethylene flotation tubs, and vinyl fenders. Steel pipe guide piles are used to secure the floats in position. The marina consists of four (4) dock systems, numbered A through D. The main walks are seven (7) feet wide and the finger floats are three (3) feet wide. Utility services include potable water (double hose bibs at slips) and electrical power (Midwest receptacles). Guide piling consist of nine (9) inch diameter painted and concrete filled steel pipe piles.

The boat basin also includes a wide concrete boat ramp, a concrete fuel and loading dock. Upland facilities include a parking area for vehicles and vehicle/boat trailer combinations, an administration office, and a restaurant/gift shop.

Condition Survey

The U.S. Army Corps of Engineers performed an inspection of the revetted moles and detached breakwater in April 2005 (O & M Inspection Report for Navigation Projects, Agat SBH, Honolulu Engineer District CEPOH-EC-T). During that inspection they found that the overall condition of the revetted moles and breakwaters were good. The report noted that the primary deficiency of the moles was the establishment of vegetation, which was recommended for removal. The north revetted mole also had some toe armor stone movement. The primary deficiency for the breakwater was an encroachment of anchor chains, anchored into the breakwater and crossing the turning basin and entrance channel. This chain was recommended for removal because not only is the chain across the channel a potential hazard to navigation, but anchoring the chain into the breakwater (between stones) could result in dislodgement of the stones when put under load, damaging the integrity of the breakwater and possibly leading to early failure. As of August 2007, the chains were still there.

The condition of the marina floats is generally good. Timber decking has recently been replaced in many areas. Some of the longer finger floats exhibit warping – evidenced by a twisting of the floats along their longitudinal axis. Three derelict sunken boats lie beneath three boat slips (A-21, B-22 and B-23).

The concrete fuel pier and loading dock is damaged and is unsafe for vehicular traffic. Access is roped off and signed as unsafe. The condition of the railing and lighting is poor.

The concrete boat ramp surface is good; however the timber fender system along the fixed boarding piers is poor. The end of one of the boarding piers has a damaged foundation pile and has caused the end of the pier to settle.

Maintenance and Operational Improvement

Maintenance items include those that were identified in the condition evaluation and include: removal of anchor chains from breakwater, vegetation removal from the revetted moles, removal of derelict sunken vessels, and repair of the loading dock and boat ramp boarding piers.

Other items identified as needing improvement include raising the height of the guide piling to accommodate typhoon storm surges, which in the past have been so high that the floats actually came off the tops of the piling and were left hanging after the water receded. A sanitary sewer pump-out is needed at this marina.

Security is also an issue. The gates are supposedly locked each evening, Even so, intruders have been known to swim around the gates and climb aboard the floats and boats. Once there, they have vandalized and stolen equipment from the boats. Increased patrols and/or the installation of security cameras may reduce the frequency of security breaches.

Vessel size limits need enforcing. The mooring of boats that are more than ten percent longer than the slip they occupy should not be allowed. Additionally, boats that are too heavy for the dock system should also not be allowed to moor at the slips. These boats can cause expensive damage to the marina floats, which were not designed for these heavier vessels. Tighter language about this type of abuse needs to be crafted and included in the marina lease agreements so that enforcement is possible.

For the marina to accommodate heavier and larger vessels, a heavier duty float system is needed. The Port should consider replacing Dock A with a heavy duty concrete float system that would be designed for heavier boats. The Port would then have at least one dock where heavier boats can be berthed.

Since the breakwater does not enclose the marina, wind driven wave surges result in strong current flow into the marina near D dock. Not only does the strong current flow affect the boats at D dock, but flows have deposited sediments making access to D dock difficult and in some areas unusable. The area around D dock needs maintenance dredging. A longer term solution requires reducing the wave driven currents into the marina. A study should be undertaken to determine the best solution to the problem. A complete connection of the existing breakwater to shore, or a full height breakwater, may not be necessary, or even desirable, to adequately address the problem.

A complete hydrographic survey of the marina basin should be performed to document the existing sedimentation problems and to determine the rate of sedimentation.

The marina occupancy rate is low. At forty percent occupancy, the marina is underutilized. Some of this is due to rates being higher than the Gregorio D. Perez Marina. However the rates are in line with other off-island marinas. Some of the reason for the high occupancy is due to the slip mix. Twenty five foot boats are often trailerable and do not require in-water mooring, so many of those size slips go unused. Any future reconfiguration should consider an appropriate slip mix for the market.

The three Federal buoys at the entrance to Agat Marina are in place. Every few years the Alpha buoy gets washed ashore by storms. The private aids that mark the entrance channel are in place but some are leaning from vertical. By working closely with the Police Department, damage to the private aids at Agat Marina can be repaired in a timely manner.

2.6.3 Harbor of Refuge



Description/Metrics

At the eastern end of Piti channel is located the Harbor of Refuge. The harbor is used primarily as a location where boats can obtain shelter from winds during typhoons. Secondly, it is used to moor vessels long term when their owners leave the island. This long term lease is limited to one year and requires the owner to leave their vessel in "super typhoon" ready condition. The harbor has moorage for approximately 52 vessels with each vessel requiring four concrete anchor blocks for moorage.



Marine concessions ring the harbor. The concessions primarily serve the tourism industry in Guam and have both in-water and on-land facilities. Their sites are leased from the Port of Guam. The concessions change over time as a result of market conditions and business successes.

Adjacent to the Harbor of Refuge is the Aqua World Marina, so called because the area is leased and managed by Aqua World, Inc. Aqua World manages boat slips as well as landside leases.

Condition Survey

A survey of the Harbor of Refuge anchorage system was performed in December 2000. The survey included an underwater inspection, using scuba gear, of all of the anchor blocks, chains and attachments.

The inspection revealed that the anchorages are covered with marine growth, including vegetation, barnacles and worms. Some of the growth is so bad that the chains have adhered to the concrete and will be difficult to separate quickly in an emergency. Many of the steel staples and chains are corroded. Some staples are broken and unusable. Some of the pennants are damaged. One anchor was buried in the silt.

By calling this facility "Harbor of Refuge", a false sense of security is being conveyed to potential users of the harbor. Once boats seek refuge there, they may find it difficult to attach to the four required anchorage blocks. If they are able to connect, the connecting hardware may fail due to its deteriorated condition. The mooring arrangement and the condition of the anchorages is such that an anchorage failure could result in damage to more vessels than the one whose anchorage has failed, as the drifting boat can impact other boats as it is driven by the wind.

It has been reported that the Piti Channel has sedimented in places, and at times there is insufficient water depth to bring larger vessels into the harbor. Most of the silting in has probably occurred due to erosion of the channel's banks over time.

Maintenance and Operational Improvement

It has been seven years since the last detailed inspection of the anchorage system. Little maintenance has been performed since that time. It can be assumed that the condition of the anchor blocks and attachments are now worse than that found during the 2000 inspection. Another detailed underwater inspection of the anchorage blocks, requiring removal of all marine growth as part of the inspection, should be performed.

Based upon the findings of that investigation, a repair and replacement project should be undertaken with the purpose of making the anchorages easily usable in the event that the harbor needs to be used as a place of shelter from approaching typhoons.

Routine maintenance on the anchorage system should be performed. At a minimum, anchorage blocks, chains and attachments should be cleaned of marine growth annually before each typhoon season. Once every 5 years, and after every typhoon, a detailed underwater inspection of the anchorages should be performed.

A hydrographic survey of the Piti Channel should be performed. Based upon the findings, dredging should be performed that will bring the water depth to a minimum constant depth of 8 feet. The channel's banks should be evaluated for erosion, and bank protection should be designed to reduce that erosion.



For several years there has been talk of the need for a boat haul out facility at the harbor of refuge. There is a need on the island for a location to haul boats out of the water for inspection and repair. Currently, boats can be hauled out of the water for inspection at Hagatna Marina. However repairs are not allowed there. A user survey should be conducted to determine the extent of the need, how often a relocated inspection and repair facility would be used, and what services are desired. The user survey should consider the potential elimination of the haul out ramp at the Gregorio D. Perez Marina should that marina be reconfigured in the future.



Section 3 Current Lease Agreements

The consultant performed a review of existing leases and agreement that the Port Authority of Guam has for use and operation of its various facilities. The results of our review are presented in this Section 3.

3.1 Introduction and Methodology

The Port Authority of Guam (PAG) currently has leases and agreements for facilities with over 50 companies and in many cases, multiple leases with the same company covering different facilities. Managing the leases and properties is a major business activity of PAG.

The Consultant reviewed the leases and agreements to determine if any posed an impediment to future development that may be undertaken following the master plan update. The review also included such items as property areas, obligations of the parties, expiration dates and synergy with other port activities.

The methodology employed involved reviewing actual lease documents that were provided by PAG staff and interviewing existing tenants. Following that review, the list was reviewed in an interview with PAG staff and additional property tours were done to gain a better understanding of the areas involved.

3.2 Summary of Findings

The following Table 3.2-1 presents a summary of major tenants on PAG property and Major Lease parameters for these tenant leases. More detailed information on active leases and location keys are presented in Appendix 3-1, Tabulation of Lease Agreements.

The review showed that, within the boundaries of the current general cargo terminal, none of the leases posed a serious impediment to potential facility redevelopment since the agreements are month to month. However, many of the activities carried out by the tenants within their lease areas are complementary to PAG's mission. In the likely event that current facilities will be either removed or redeveloped, PAG should be sensitive to the needs of the current tenants and work with them to relocate. Refer to the above reference location keys in Appendix 3-1.

The GEDCA lease with CASAMAR, assigned to PAG, for facilities at berth F-2 is an exception to the above. This lease still has more than 40 years to run and the tenant in an interview expressed no desire to move. As long as the tenant continues to meet its obligations, there is little redevelopment that can be done in this area.

The location of pipelines (some of which run under the existing container yard) and utilities will need to be considered in any redevelopment plan. This is addressed more fully in other sections of this report.

Most of the leases, particularly the month to month agreements, have either no or limited provisions for escalation of rent. PAG staff should review the rental fees to ensure that they represent market rates.

Some of the zoning and land uses suggested in the current master plan are restrictive to future PAG needs relative to redevelopment and expansion, particularly in light of the impending volume increases as a result of the military buildup. For example, the land in the area of the seaplane dock suggests a potential recreational use. The highest and best use of this area may be for industrial use to construct facilities for cargo imports, e.g. cement and other construction materials.

Very little development appears to have occurred in the Hotel Wharf area since the lease with the developer was executed. The purpose of the development of Hotel Wharf was to provide for facilities to service the fishing industry. That development needs to be reviewed and the agreement should either be enforced or renegotiated.

Table 3.2-1 Summary of Major Lease Agreements

Lessee	Operation/Facility	Area	Term
CASAMAR	Fishing Fleet Services	Lot 5, GEDCA Tract	Renewed March 2000 with 5-10 year lessee options
Guam Transport & Warehouse	Storage M& R Facilities	Part of Parcel 4 between Checkpoint and Unitek – 5000 Square feet	Month to Month
Guam YTK Corp.	Construction & operation of fisheries facilities, including ports, docks, storage, shopping, recreational and support facilities	Approx. 12000 square meters at Hotel Wharf	5 years with 8 – 5 year lessee options beginning 12/14/01
Hanson Cement	Cement imports	Parcels A & B, GEDCA Tract	Renewed in 2001 with 5-10 yr. lessee options
Horizon Lines LLC	General office space, storage, M &R of Trucks, chassis & containers	4155 Sq. Ft. – office; 9600 Sq. ft warehouse in CFS; 11,082 Sq. Ft. under eave space	5 years ending 5/31/09
Matson Navigation Company	Office space	435 sq. ft.	Month to month
Matson Navigation Company	Office space	2521 sq.ft.	Month to month
Matson Navigation Company	Amendment to previous lease entry	2755 sq. ft.	Month to month
Matson Navigation Company	Warehousing and repair	10,800 sq.ft. CFS (inside); 3295 sq.ft. CFS (outside)	Month to month
Matson Navigation Company	Staging of chassis and containers	1330 sq. ft.; area E, parcel 1	Month to month
PRI South Pacific	Tank farm management agreement	Golf pier and pipelines	Expires on 3/31/20
Mobil Oil Guam, Inc.			
Pacific Demolition and Dismantles (PDD)	Temporary placement or pre-staging of metallic scrap, tires and debris for later removal	Parcel 1, Seaside; 24,960 sq. ft.	Month to month

Table 3.2-1 Summary of Major Lease Agreements (Continued)

Lessee	Operation/Facility	Area	Term
Shell Guam Inc.	Extension of bunker line easement agreement on PAG property	*Note: No drawings were attached to the lease reviewed	Expires on 11/30/11 with 3-5 year options by lessee
Shell Guam Inc.	Easement extension "dog leg"	*Note: No drawings attached to the agreement	Expires 11/30/11 with 3-5 year options by Shell
Shell Guam Inc.	2 nd agreement to extend lease and easement rights	*Note: No drawings were attached to the agreement	Expires on 11/30/11 with 3-5 year options by Shell
Shell Guam Inc.	Lease extension "Finger Tip"	*Note: No drawings were attached to the agreement	Expires on 11/30/11 with 3-5 year options by Shell
Shell Guam Inc.	Lease extension "main pipeline"	*Note: No drawings were attached to the agreement	Expires on 11/30/11 with 3-5 year options by Shell
APL/Sealand and by assignment to Matson and Horizon)	Agreement for relocating crane from Subic Bay to Guam		Ongoing for the crane's useful life
South Pacific Petroleum Corp. (SPPC)	Assignment of Exxon/Mobile Lease	Lot 2, Cabras Is.; a portion of lot 3; ESSO fire fighting pump house & fire fighting system; a five foot pipeline easement per drawings	
Tidewater Distributors, Inc.	Warehouse and office space	6201 square feet of Warehouse space and 510 square feet of office space in Whse 1	Month to month
Tidewater Distributors, Inc.	Warehouse space	3395 sq. ft. in Whse 2, bay 9	Month to month
V. Angoco Trucking	Open storage space for staging of chassis and containers	2400 sq. ft., part of parcel 4 between checkpoint and UNITEK	Month to month
Aqua World	Marina Management	Harbor of Refuge	Month to month
Aqua World	Marina Management	Harbor of Refuge	Month to Month
GRSL	Oil Response	Seaplane Ramp	Month to Month
GRSL	Oil Response	Harbor of Refuge	Month to Month

Section 4 Cargo Forecasts

The Socio-economic Trends & Forecasts were presented in Section 1.2. This section provides forecasts of expected cargo volumes and vessel calls.

4.1 Containers

This section provides a summary of recent trends as well as forecasts of expected cargo volumes and vessel calls.

4.1.1 Description of Carrier Services

Vessels serving Guam are involved in three trade routes, including US West Coast, Asia/foreign and Micronesia trans-shipment services.

USWC-Guam Service

The primary carriers on the USWC-Guam routes are Matson Navigation Company (Matson) and Horizon Lines, Inc (Horizon). These carriers have recently upgraded their service to Guam.

Matson replaced its prior Guam Service with American President Lines with an integrated Hawaii/Guam/China service that began in February 2006. The service currently employs five containerships in a five-ship string that carries cargo from the U.S. Pacific Coast to Honolulu, then to Guam. The vessels continue to China, where they are loaded with cargo to be discharged in Long Beach. Matson vessels serving Guam range from a capacity of 2,500 to 2,800 TEUs. See Figure 4.1-1. As shown in Table 4.1-1, Matson vessels have an average Guam payload of 690 containers (354 full and 336 empty).

Figure 4.1-1 Matson Service to Guam



Figure 4.1-2 Horizon Service to Guam



Horizon operates under a cargo space charter and transportation service agreement with Maersk. As shown in Figure 4.1-2, Horizon currently operates five vessels that sail from the U.S. west coast to Hawaii, continuing from Hawaii on to Guam, and then from Guam on to Hong Kong and Kaohsiung, with a return trip to Tacoma, Washington, and Oakland, California. Horizon uses Maersk containers to carry a portion of its cargo westbound to Hawaii and Guam, where the contents of these containers are then unloaded. Horizon then ships the empty Maersk containers onwards to the two ports in Asia. When these vessels arrive in Asia, Maersk unloads these empty containers and replaces them



with loaded containers on Horizon vessels for the return trip to the U.S. west coast. Horizon vessels serving Guam (Hunter class vessels) have a carrying capacity of 2,824 TEUs. As shown in Table 4.1-1, Horizon vessels have an average Guam payload of 514 containers (252 full and 262 empty).

Foreign Services

Foreign trade routes (mainly Asia) are served by Kyowa Steamship Co. (Kyowa) and Marianas Express Lines (MEL).

Kyowa operates a feeder service that connects with NYK and MOL out of Asia. The vessels (i.e., Asian Hibiscus, Kyowa Mermaid, and Kyowa Salvia, among others) call every two weeks. These vessels are multi-purpose and can handle containers, Ro-Ro and break-bulk cargoes. Marianas Shipping Agencies is the agent for Kyowa Steamship Co. As shown in Table 4.1-1, Kyowa vessels have an average payload of 99 containers (51 full and 48 empty), which includes trans-shipment as well as direct Guam service. Kyowa vessels also carry break-bulk cargoes, which is described in a latter section.

Figure 4.1-3 Kyowa Service to Guam

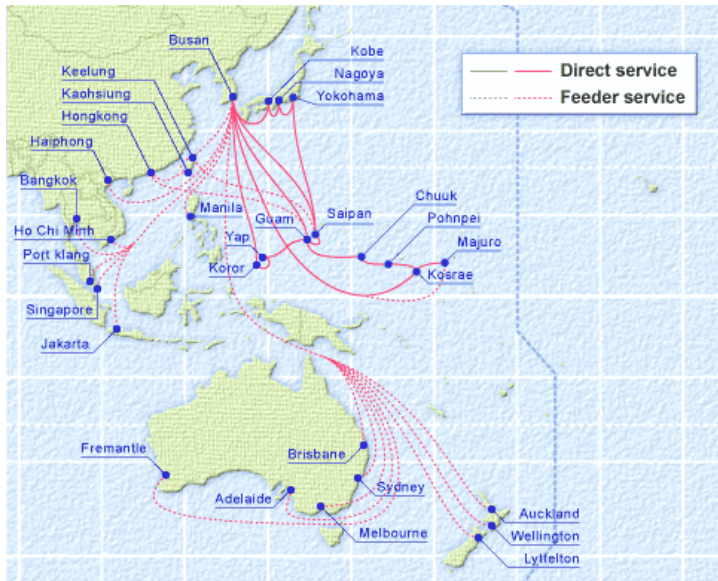

CTSI is a logistics provider that acts as general agent for Marianas Express Lines. In addition, they also provide drayage and other logistics services. Marianas Express Lines (MEL) provides weekly service to Guam with 3 vessels of 800 TEU, 850 TEU and 1001 TEU. The rotation for the Micronesia Express Service (MXS) is Hong Kong, Kaoshiung, Saipan, Guam, Koror, Yap, Davao, Gensan, and Cebu Service. As shown in Table 4.1-1, MEL vessels have an average payload of 275 containers (123 full and 152 empty), which includes trans-shipment as well as direct Guam service.

Trans-Shipments Services

The MV Super Shuttle, operated by Seabridge Inc., carries cargo to/from Guam and the CNMI. This vessel can carry 132 20-foot containers or their equivalent, and has a Guam-Saipan transit time of 12 hours. As shown in Table 4.1-1, the Super Shuttle has an average payload of 95 containers (49 full and 46 empty). The Super Shuttle serves the needs of Matson, Horizon and other carriers. There are also barge services operating between Guam and the CNMI.

Matson operates trans-shipment service from Guam to FSM and Marshall Islands. The vessel Islander (formerly MV Cerrina) has a capacity for 650 TEUs and is equipped with two onboard cranes. This service replaces the monthly barge service to these islands from Hawaii with a bi-weekly ship service operating from Guam. Cargo originating on the Pacific Coast and in Hawaii is sent to Guam on the



weekly Guam vessel and transferred the Islander that sails every two weeks to Kwajalein, Ebeye and Majuro. This ship also calls at ports on the islands of Chuuk, Pohnpei and Kosrae in the eastern part of the Federated States of Micronesia. Matson also offers a weekly service via MEL to Yap, Palau, Saipan, Tinian and Rota.

Horizon Lines has trans-shipment cargo moving to the Federated States of Micronesia and the Republic of Palau through its subsidiary (Horizon Lines of Guam) with through bills of lading for service between Chuuk, Pohnpei, Kosrae, Yap and Palau, and the United States. This trans-shipment service is provided by Kyowa.

Table 4.1-1 Vessel Call Summary for 2007 (Jan through mid-Aug)

Group	# Voyages	Lifts per Call (average)						Total
		Full In	Full Out	Full Total	Mty In	Mty Out	Mty Total	
USWC								
Matson	35	350	4	354	46	290	336	690
Horizon	35	250	2	252	58	204	262	514
Foreign								
CTS	33	122	2	123	75	77	152	275
Kyowa	29	43	8	51	14	34	48	99
Trans-shipment								
Seabridge	49	27	22	49	43	3	46	95
Matson	17	18	171	189	177	2	179	368

Source: Port Authority of Guam

4.1.2 Container Trends & Forecast by User Group

The Port of Guam has averaged 145,000 TEUs of containerized cargo per year between 1991 and 2006, ranging from a minimum of 132,000 TEUs in 2000 to a maximum of 163,000 TEUs in 1998. Containers come in 20 foot, 40 foot and 45 foot lengths. Currently, a container equals approximately 1.7 TEUs in Guam.

Figure 4.1-4 Port of Guam Container Trends (TEUs)

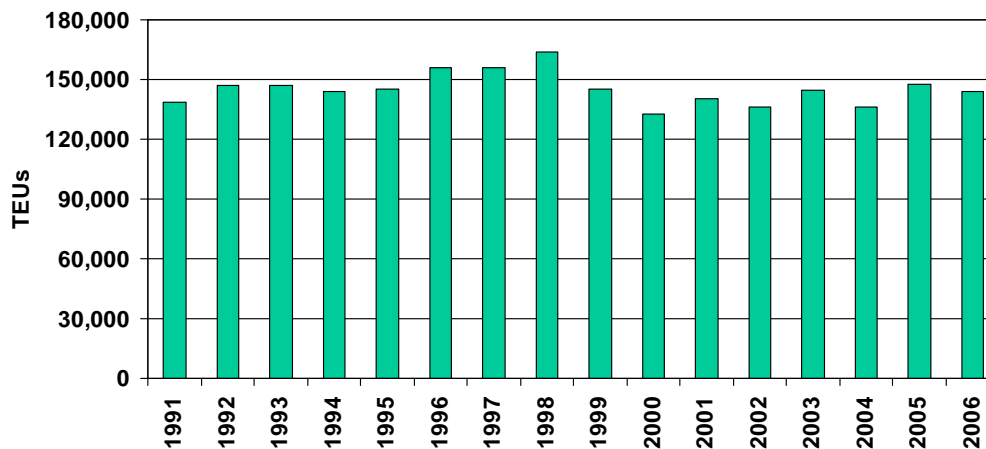

Overall volumes have been relatively steady. However, conditions are changing within the major trade routes, which are described below.



Department of Defense

As noted previously, the DOD is planning a major build-up of forces on Guam. This will impact container volumes in three ways. First, during the construction period the DOD contractors will import substantial volumes of materials and supplies, a significant portion of which will be containerized. Second, the DOD will bring in active duty personnel and their dependents. This will also increase the flow of household goods, personal vehicles and goods sold at the commissary. The DOD has estimated the containerized cargo volumes associated with these flows. Finally, active duty personnel and their dependents will purchase goods from local businesses. This cargo volume is included in the local/tourism market segment.

The container volumes associated with construction projects and military container shipments (household goods, private vehicles and commissary products) is expected to increase from around 18,000 containers in 2007 and peak at 89,000 containers in 2015, when most of the construction is completed. After construction, the additional DOD personnel on Guam will average around 38,000 containers per year.

During the buildup in construction, DOD container volumes will comprise around 45 percent to 47 percent of total container volumes. After construction, DOD container volumes will comprise around 25 percent to 26 percent of total container volumes moving through the Port.

Local/Tourism

The consultants estimate that the container traffic associated with the local/tourist market segment is expected to grow from 70,000 containers in 2007 to 112,000 containers in 2027. This corresponds to annual growth of 3.5 percent from 2007 through 2012; 2.7 percent from 2012 through 2017; and 1.7 percent from 2017 through 2027.



Trans-Shipments

Container volumes are expected to remain in the 11,000 to 13,000 range per year in service to the trans-shipment markets.

4.1.3 Container Forecast by Trade Route

This section provides forecasts by trade route.

Trans-Shipments

The increased trans-shipment volumes to FSM, Palau and Marshall Islands are expected to offset the expected declines to/from CNMI. Container volumes to/from CNMI are based upon an expected loss of garment manufacturing during the period 2007 to 2011. After 2011, container volumes increase at 1.5 percent to 1.7 percent in line with expected growth in population and the tourist industry. Container trade with FSM, Marshall Islands and Palau are expected to grow at around 1.0 percent per year in line with expected population and economic growth.

Table 4.1-2 Guam Container Traffic Forecast – By Source (Boxes)

Year	Source of Container Traffic			Percent by Source			
	Trans-shipment	Department of Defense	Local & Tourist	Total	Trans-shipment	Department of Defense	Local & Tourist
2007	15,000	18,000	70,000	103,000	15%	17%	68%
2008	13,000	19,000	72,000	104,000	13%	18%	69%
2009	13,000	21,000	74,000	108,000	12%	19%	69%
2010	12,000	39,000	78,000	129,000	9%	30%	60%
2011	11,000	58,000	80,000	149,000	7%	39%	54%
2012	11,000	78,000	83,000	172,000	6%	45%	48%
2013	11,000	81,000	86,000	178,000	6%	46%	48%
2014	11,000	85,000	86,000	182,000	6%	47%	47%
2015	11,000	89,000	90,000	190,000	6%	47%	47%
2016	11,000	76,000	93,000	180,000	6%	42%	52%
2017	11,000	46,000	95,000	152,000	7%	30%	63%
2018	12,000	38,000	96,000	146,000	8%	26%	66%
2019	12,000	38,000	98,000	148,000	8%	26%	66%
2020	12,000	38,000	100,000	150,000	8%	25%	67%
2021	12,000	38,000	101,000	151,000	8%	25%	67%
2022	12,000	38,000	103,000	153,000	8%	25%	67%
2023	12,000	38,000	105,000	155,000	8%	25%	68%
2024	12,000	38,000	107,000	157,000	8%	24%	68%
2025	12,000	38,000	108,000	158,000	8%	24%	68%
2026	13,000	38,000	110,000	161,000	8%	24%	68%
2027	13,000	38,000	112,000	163,000	8%	23%	69%
Compound Annual Growth Rate							
2007-12	-6.0%	34.1%	3.5%	10.8%			
2012-17	0.0%	-10.0%	2.7%	-2.4%			
2017-27	1.7%	-1.9%	1.7%	0.7%			
2007-27	-0.7%	3.8%	2.4%	2.3%			

Source: BST Associates using data from DOD

Foreign

Container volumes on foreign trade routes (mostly to/from Asia) are expected to increase from around 18,800 containers in 2007 to a peak of around 43,000 during the DOD construction build-up. The Consultant assumes that around 50% of the DOD construction materials moving in containers will come



from Asia. However, after build-up, container traffic on the Asian trade routes will range from 22,000 containers in 2018 to 25,200 containers in 2027.

US West Coast

Container traffic on the USWC routes is expected to increase from around 69,200 containers in 2007 to a peak of 135,400 containers in 2015, largely as a result of the DOD build-up. After the DOD construction is completed, US carriers will control the lion's share of container cargo to/from Guam, absorbing all of the goods associated with the increased military active duty and dependents. This would be a reasonable scenario considering that most of this cargo currently moves from the USWC.



Table 4.1-3 Guam Container Traffic Forecast – By Route (Boxes)

Year	CNMI	FSM/MI	Foreign	USWC	Total
2007	8,100	6,900	18,800	69,200	103,000
2008	6,500	6,900	19,500	71,800	104,700
2009	5,500	7,000	20,800	74,600	107,900
2010	4,500	7,100	28,500	88,300	128,400
2011	3,500	7,100	35,300	102,800	148,700
2012	3,500	7,200	43,000	118,300	172,000
2013	3,600	7,300	43,500	122,900	177,300
2014	3,700	7,400	42,700	128,400	182,200
2015	3,700	7,400	43,400	135,400	189,900
2016	3,800	7,500	36,800	132,500	180,600
2017	3,800	7,600	25,100	115,800	152,300
2018	3,900	7,600	22,000	111,800	145,300
2019	4,000	7,700	22,300	113,200	147,200
2020	4,000	7,800	22,700	114,500	149,000
2021	4,100	7,900	23,000	115,900	150,900
2022	4,100	7,900	23,400	117,300	152,700
2023	4,200	8,000	23,800	118,800	154,800
2024	4,200	8,100	24,100	120,200	156,600
2025	4,300	8,200	24,500	121,700	158,700
2026	4,400	8,200	24,900	123,200	160,700
2027	4,400	8,300	25,200	124,500	162,400
Compound Annual Growth Rate					
2007-12	-15.4%	0.9%	18.0%	11.3%	10.8%
2012-17	1.7%	1.1%	-10.2%	-0.4%	-2.4%
2017-27	1.5%	0.9%	0.0%	0.7%	0.6%
2007-27	-3.0%	0.9%	1.5%	3.0%	2.3%

Source: BST Associates using data from DOD

4.2 Break-bulk

Break-bulk cargo includes a wide variety of commodity types that cannot fit into containers (steel plates, sheets and pipes, cement in super bags, asphalt in drums, and motor vehicles, among other cargoes). Most of the break-bulk cargo inbound to Guam is for the construction industry. Most of the outbound break-bulk is also construction materials (moving on trans-shipment routes) as well as scrap metal, automobiles and a variety of other cargoes.

Break-bulk cargo has increased from around 99,000 revenue tons in 2001 to 105,000 revenue tons in 2006. Approximately 76 percent of the break-bulk is inbound, with 93 percent from foreign sources and 7 percent from US domestic sources. The remaining 24 percent of break-bulk is outbound, with 78 percent to foreign markets and 22 percent to US domestic markets. See Table 4.2-1.

Break-bulk cargo can move on vessels that also carry containers or on vessels that only carry break-bulk. On foreign trade routes, approximately 43 percent of break-bulk was handled on vessels that also carry containers (primarily Kyowa) and 57 percent was carried on break-bulk only vessels. On US domestic trade routes, approximately 51 percent of break-bulk was handled on vessels that also carry containers (Matson and Horizon) and 49 percent was carried on break-bulk only vessels.

Figure 4.2-1 Guam Break-bulk Trends & Forecasts (Revenue Tons)

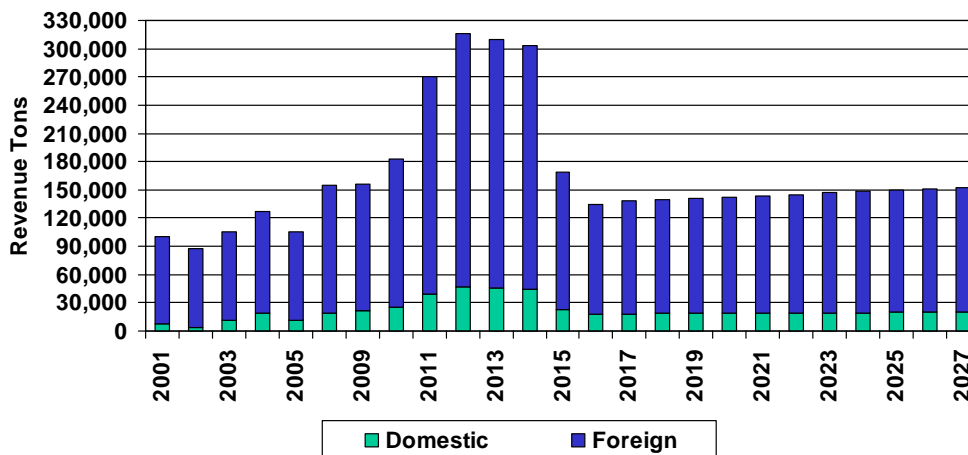

Break-bulk volumes (i.e., the portion that includes construction materials) are expected to increase dramatically in response to the DOD build-up, growing present volumes to around 270,000 to 320,000 revenue tons during the period from 2010 through 2013. During this period, foreign break-bulk imports are expected to reach an average of 234,000 revenue tons and domestic US break-bulk imports are expected to reach an average of 42,000 revenue tons. After the construction period, inbound break-bulk is expected to grow from 109,000 revenue tons in 2015 to 121,000 revenue tons in 2027 or at around 0.8 percent per year. See Table 4.2-1.

As more information becomes available DOD/JGPO needs to clarify/confirm the applicability of the "Buy American" act to construction materials for DOD projects as this could determine the break-bulk origin.

Outbound break-bulk is expected to grow at around 1.5 percent per year, from a base of 23,000 revenue tons in 2007 to around 31,000 revenue tons by 2027.



Table 4.2-1 Guam Break-bulk Cargo Forecast (Revenue Tons)

Year	Inbound			Outbound			Total		
	Domestic	Foreign	Total	Domestic	Foreign	Total	Domestic	Foreign	Total
2002	1,700	67,400	69,100	5,600	25,100	30,700	7,300	92,600	99,800
2003	800	56,800	57,600	3,500	26,500	30,000	4,300	83,300	87,600
2004	4,400	81,200	85,500	6,800	12,900	19,700	11,100	94,100	105,200
2005	6,200	85,800	91,900	12,200	23,300	35,500	18,400	109,000	127,500
2006	5,700	77,700	83,400	5,600	16,500	22,100	11,300	94,200	105,500
2007	15,800	116,500	132,300	2,900	20,100	23,000	18,700	136,600	155,300
2008	16,000	100,100	116,100	2,900	20,400	23,300	18,900	120,500	139,400
2009	18,700	114,300	133,000	2,900	20,700	23,600	21,600	135,000	156,600
2010	22,600	135,600	158,200	3,000	21,000	24,000	25,600	156,600	182,200
2011	36,900	209,500	246,400	3,000	21,300	24,300	39,900	230,800	270,700
2012	44,000	247,400	291,400	3,100	21,600	24,700	47,000	269,000	316,000
2013	42,800	241,500	284,300	3,100	21,900	25,100	46,000	263,400	309,400
2014	41,800	236,100	277,900	3,200	22,300	25,400	45,000	258,300	303,300
2015	20,100	123,200	143,400	3,200	22,600	25,800	23,300	145,800	169,200
2016	14,700	94,200	108,900	3,300	22,900	26,200	17,900	117,200	135,100
2017	15,100	96,900	112,000	3,300	23,300	26,600	18,400	120,200	138,600
2018	15,200	97,700	112,900	3,400	23,600	27,000	18,600	121,300	139,900
2019	15,300	98,500	113,900	3,400	24,000	27,400	18,800	122,500	141,300
2020	15,500	99,300	114,800	3,500	24,300	27,800	18,900	123,700	142,600
2021	15,600	100,200	115,700	3,500	24,700	28,200	19,100	124,900	144,000
2022	15,700	101,000	116,700	3,600	25,100	28,700	19,300	126,000	145,300
2023	15,800	101,800	117,600	3,600	25,500	29,100	19,400	127,200	146,700
2024	15,900	102,600	118,500	3,700	25,800	29,500	19,600	128,400	148,100
2025	16,100	103,400	119,500	3,700	26,200	30,000	19,800	129,700	149,500
2026	16,200	104,300	120,500	3,800	26,600	30,400	20,000	130,900	150,900
2027	16,300	105,100	121,400	3,900	27,000	30,900	20,200	132,100	152,300
Compound Annual Growth Rate									
2002-07	56.2%	11.6%	13.9%	-12.3%	-4.3%	-5.6%	20.7%	8.1%	9.2%
2007-12	22.7%	16.3%	17.1%	1.3%	1.4%	1.4%	20.2%	14.5%	15.3%
2012-17	-19.3%	-17.1%	-17.4%	1.3%	1.5%	1.5%	-17.1%	-14.9%	-15.2%
2017-27	0.8%	0.8%	0.8%	1.7%	1.5%	1.5%	0.9%	0.9%	0.9%
2007-27	0.2%	-0.5%	-0.4%	1.5%	1.5%	1.5%	0.4%	-0.2%	-0.1%

Source: BST Associates

4.3 Bulk Cargo

There are bulk imports of cement to Guam of approximately 100,000 tons per year at the present time. Bulk cement imports are also expected to increase dramatically with the DOD construction build-up to 250,000 to 500,000 tons per year during the period 2010 to 2013. After the construction is completed, bulk cement imports are expected to return to 90,000 to 110,000 tons per year. The uncertainty about the construction process and the lack of specific details for specific projects are the main reasons for the variation between the low and high forecast volumes. The low estimate is based on discussions with industry sources and the high forecast assumes that tonnage bulk increases in proportion with the value of construction contracts. As construction contracts are finalized, the bulk cargo forecasts should be re-evaluated.

Figure 4.3-1 Guam Bulk Cement Imports (Tons)

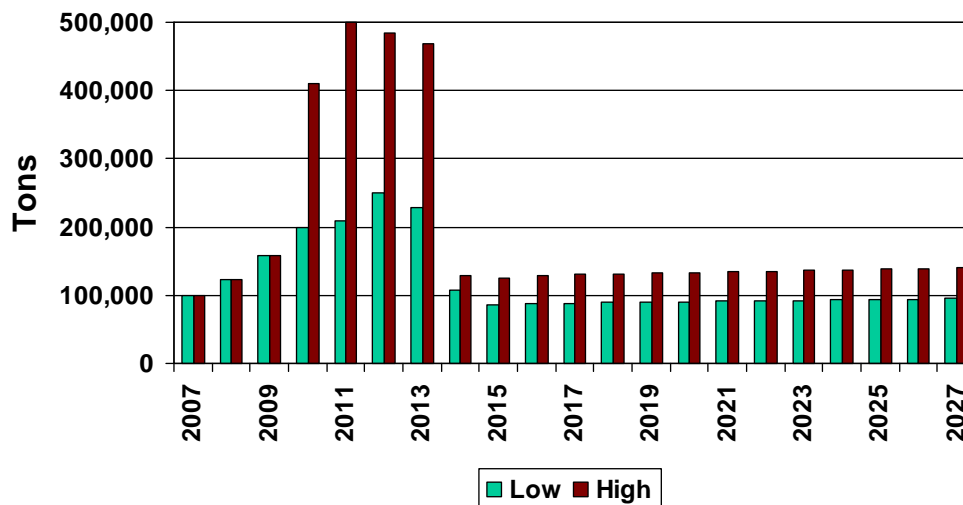

In addition, there may be a new coal power plant developed in Guam. Project sponsors indicate that approximately 200,000 tons of coal per year would be required to serve the plant. This would require new dock facilities as well as a transport system to move the product from the dock to the coal storage facilities.

4.4 Cruise Vessel Passengers

Passenger vessel traffic⁵ at Guam has averaged approximately 3,100 passengers per year during the past few years. This represents a small percentage of overall visitors (i.e., 0.3% of the 1.2 million visitors to Guam). Most cruise passengers are from Japan (61 percent) or the US (15 percent).

Guam has received around 6 to 8 calls on average per year in the recent past with approximately 600 passengers per call. The current vessels range in length from 400 to 800 feet and carry between 350 and 950 passengers. The vessels stay a partial day in Guam (i.e., arrive 8am and depart 6pm).

Table 4.4-1 Port of Guam Passenger Vessel Visitor Trends

Country	2003	2004	2005	2006	2007-Aug	Average Annual
Japan	1,829	2,741	1,075	1,867	1,305	1,889
US Mainland	217	1,232	149	532	67	471
Europe	81	482	28	306	6	194
Australia	61	488	7	149	2	152
Philippines	112	342	67	15	10	117
Hawaii		81	336	16	3	93
Other	58	141	28	53	58	72
Canada	40	182	9	26	1	55
RMI		62		16		17
CNMI		1	23	4	14	9
Other *	8	28	9	53	3	22
Total	2,406	5,780	1,731	3,037	1,469	3,091

Note: Other includes: CNMI, FSM, Palau, Korea, China PRC, Taiwan, Hong Kong, Vietnam, Thailand, and Nauru
Source: Guam Visitor Bureau

Growth in cruise activity is largely supply-driven, with the introduction of new ships, new itineraries, and new themes promoting customer interest and sales. As an example of new itineraries, the Steven Ambrose Historical Tours is presenting a tour on the War in the Pacific Tour for the 63rd anniversary of Iwo Jima on March 5 - 16, 2008. Tour will commence in Hawaii and will visit Saipan, Tinian, Guam, before attending the special ceremonies on Iwo Jima.

The overall forecast for world cruise activity is projected at around 4.5% to 5.5% in next ten years then decreasing to 3.5% to 4.5% during the period 2017 to 2027, according to the Cruise Line International Association. Cruising is expected to grow at a slightly faster rate than overall tourism.

Most of the tours from Japan (and the US) are short in duration, with around 85% less than 6 nights. This tends to favor tours tied with Asian countries.

The opportunities for Guam appear favorable for several reasons. Recently, several cruise lines have expressed an interest in expanding cruise operations in Guam. The lines are looking to differentiate themselves by offering unique venues. They are interested in expanding into Asia and other world destinations, particularly to exotic, interesting and intriguing locations. If successful, Guam could attract 20 to 30 calls per year in the next five years, with growth up to 60 to 100 calls in the long-run.

This will require a concerted effort to achieve, including improved port facilities such as streamlined security and passenger screening facilities and improved visitor attractions.

⁵ Visitors on passenger vessels primarily include cruise vessels but may also include other visiting ships and yachts.

Section 5 Alternatives Analyses

5.1 Future Demands and Existing Capacity Constraints

The Throughput Capacity of a cargo terminal can be constrained at different locations in the cargo transportation system. For a container terminal these would normally include berth service, trade pattern demands, crane service, yard storage capacity, and truck gate operations. There was insufficient information available from the Port's computer system to perform a detailed analysis of each of these elements. However, the composite picture presented by current below-industry production rates, the likely limited remaining service life for aged equipment, and the absence of modernized terminal and gate operating systems leads us to conclude that existing facilities and systems will not be able to support the Cargo Forecasts described in Section 4.

Detailed Cargo Forecasts for the next twenty years by type of cargo are presented in Tables 4.1-2 (Containers), Table 4.2-1 (Break-bulk), Figure 4.3-1 (Cement). We selected the peak demand year from this information and compared it to our capacity estimates for each of the above types of cargo. Accordingly, Capacity Constraints "As Is" with Current Trade Patterns may be summarized as follows.

Table 5.1-1 Capacity Constraints by Type of Annual Cargo

Containers

□ Highest Throughput Yr 2007	103,000 Lifts	175,000 TEU
Est. Capacity	120,000 Lifts	204,000 TEU
Peak Future Demand	190,000 Lifts	323,000 TEU (in 2015)

Shortfall in Peak Year	70,000 Lifts	

Break-bulk

□ Highest Throughput Yr 2006:	155,000 Tons
Est. Capacity	Close to Capacity
Peak Future Demand	316,000 Tons During Construction

Shortfall in Peak Year	161,000 Tons

Cement

□ Highest Throughput Yr 2006:	100,000 Tons
Est. Capacity	125,000 Tons
Peak Future Demand	250,000 Tons During Construction

Shortfall in Peak Year	125,000 Tons (See Section 6.4 for high forecast implications)

Liquid Fuels

- Have Excess Capacity (See discussion with Oil Companies)

It is clear that major capacity improvements must be implemented in order to address the future demands for the Commercial Cargo Terminal and for Cement Imports.

5.2 Planning Inputs

5.2.1 Vessel Size & Characteristics

In assessing Vessels for Berth Service in the future we considered the trends in the container shipping industry. Vessels are becoming larger for the Transpacific Service between the USWC and Asia. Until 1985, call container vessels were designed to pass through Panama Canal locks. These generally had capacities up to 3,200 TEU. These are called PANAMAX Class (PMX) Vessels. The first container vessel that was too wide to pass through the canal, referred to as a Post-PANAMAX (PPMX) vessel, was put in

service in 1986. These were the fourth generation of cellular container vessels and the first generation of PPMX vessels. Once this barrier was breached new and larger container vessels have been put into service through the present. The largest container carrier currently in service is the Emma Maersk, a third generation off PPMX with a capacity of 11,000 to 13,000 TEU depending on how one assesses TEU capacity. In 2007 Panama embarked on a program to construct a third new lock that can support container vessels up to 12,000 TEU (55m or 180' wide lock). This is expected to further accelerate the number of large PPMX vessels that will be put into service in the future.

No PPMX vessels have called at Guam to date. These vessels are currently economical for use in long direct voyages between ports with large population centers. However in the future (say 10/15 years) some of the older PPMX vessels displaced from transpacific service by larger PPMX vessels may be used on other non-direct routes. Also over long time horizons, competitive pressures for economies of scale may also dictate the placement of the smaller PPMX vessels in non-direct transpacific service. Because of these reasons it is important to identify the current and future design vessels for PAG. The following Table 5.2-1 tabulates an idealized list of the classes of container vessels in service.

Table 5.2-1 Class of Container Vessels in Service

Classification	TEU	LOA (Feet)	Draft (Feet)	Beam (Feet)	Width (Container)	DWT
Handy Size	2,200	640	33	93	11	25,000
Maunawili	2,600	712	41	105.6	13	37,752
Horizon Hunter	2,824	729	39	98	12	39,266
LMSR Military Vessel	N/A	950	37	105.6	N/A	34,000
Representative - Panamax	3,200	850	41	105.6	13	50,000
Post Panamax	4,800	900	45	135	16	90,000
Super Post Panamax	8,000	1,150	48	150	18	100,000
Ultra Post Panamax	13,000	1,300	51	180	22	140,000

The table also presents representative samples of the larger vessels that currently call at PAG and the Military Sealift Command vessel that will call at PAG. It is assumed that the Nimitz Class Aircraft Carriers will not be deployed to the commercial cargo berth since other facilities to berth these vessels are being developed in the harbor. Other break-bulk and bulk cargo vessels that may on occasion call at the terminal will generally fit within the planning envelope of the above vessels.

The consultant recommends that in the Near Term the facilities in general be designed for size of vessels up to the PMX Class of vessel. Also in general Long Term facility design should address accommodation of the highlighted PPMX vessels.

5.2.2 Berth Length

For preliminary planning purposed until validated by utilization analysis, the required minimum berth length for the cargo vessels was estimated to be 2,250'. This will accommodate one of the USWC container vessels currently calling, a Handy Size and a smaller handy such as the CTS Haneburg with sufficient clearance for line handling and safety. In addition additional small berth length would be necessary to support overflow fishing vessels if necessary from the adjacent Berth F-3.

5.2.3 Operating Template for a Modern Cargo Terminal

During the Facilities and Operations assessment described in Section 2, the Consultant applied a Facilities & Operational Template to the existing PAG facilities. This template used the Facilities and Operating parameters appropriate for a typical modern U.S. container terminal as the benchmark for identifying deficiencies. For example in assessing the requirements for a new gate (or modification of the existing) the yard stick was the ability to process an incoming container truck into the terminal within 3 minutes, on average. A container truck leaving the terminal should be able be processed through the terminal gate within 1 minute, on average. In planning the area needed and estimating the cost of the truck processing



and gate arrangements the features needed to meet these benchmarks have been included. This type of operating template was also applied to the design of other terminal elements such as the truck gate, container yard, apron, circulation lanes, security systems etc.

5.2.4 Planning Horizon & Timeframes

This Master Plan Update was performed for a planning horizon of 20 years with the start year of 2008. Within this planning horizon for the purposes of making recommendations for development of facilities and equipment it is important to differentiate between recommendations driven by a near-term requirement and a long term need that may be subject to events and conditions that occur in the future.

For instance the first PPMX vessels calling on Guam may eventually request service sometime in the future but it may not be cost-effective to provide the facilities needed for serving these vessels at this time. For example the berth depth would have to be at least 48' to serve the smallest PPMX vessel but only 40' to 42' maybe needed for all other vessels in the interim. So it is reasonable to design costly new wharf structures, which cannot easily be modified, to support a deeper draft vessel in the future but it may not be cost effective to perform the additional dredging now when it is not needed. Because of such intangibles the Consultant recommendations will use the following terminology for near term and long term.

Near Term Applies starting at the beginning of the 20 year Planning Horizon
Long Term Occurs some 10 to 15 years into the planning horizon.

It is important also to remember that the nature of planning requires that updates be performed in the future from time to time in order to validate and refine the recommendations made and address developments that cannot be forecast at this time.

5.3 Alternate Terminal Location

One of the first questions that must be addressed when planning a modernization program is whether it is better to relocate to a new green-fields site or is it more feasible and economical to modernize at the same location. This question was quickly put to rest for PAG for several reasons including the following.

- A new green-fields port of this nature based on other projects is likely to cost in range of \$300 to \$500 Million depending on various site factors.
- Figure 2.1–2, “Commercial Port & Vicinity Land Use Designations” shows that there is no readily available land for such a project. Land areas comparable to the Cargo Terminal (CT) land use designation would have to be created.
- Locating a suitable site, performing the field and other studies and most importantly obtaining Federal Permits at a “green-fields” location with no prior pattern of operation is likely to take several years. There is no time available for this option.
- Finally we found that there were considerable assets, albeit outdated, available at the current location to facilitate modernizing the Cargo Terminal in place more quickly and more economically.

Because of the above considerations, the “green-fields” alternative was not considered for the cargo terminal.

5.4 Container Terminal Alternatives

Terminal Layout and design is driven not only by the physical layout of the property and transportation infrastructure but also by the type of container handling system chosen by the Terminal Operator. Four container handling systems were used as the basis for developing terminal layouts. The following systems were considered reasonable for the type and size of the terminal.

- Rubber Tired Gantry (RTG) System
- Combination Wheeled + Top-Pick System
- Top Pick System

- Reach Stacker

NOTE: All but the “Combination Wheeled + Top-Pick” alternate container handling equipment were considered as a system for storage and retrieval of all containers in the yard and not as individual pieces of equipment for performing certain tasks. For example the Rubber Tired Gantry (RTG) system was considered as an entire system for the yard as opposed to the manner in which it is used currently for handling selected containers in one section of the yard.

Preliminary comparative layouts were developed for each of the above alternates and are attached in Appendix 4-1.

These alternatives were analyzed on a preliminary basis for the cargo demand for the peak year, 2015 as presented in Section 4. The following considerations were integrated into the analysis.

- Segregation of the type of cargo by route or shipping line
- Dwell time considerations for the above categories
- Typical anticipated weekly and seasonal peaking factors
- Typical yard stacking configurations consistent with operational practice and equipment
- Identification of the number and type of equipment needed.

Detail tabulation of results from the analysis is presented in Appendix 4-1 for each of the preliminary analyses. More detailed planning assumptions are also included in the appendix. The results of the analysis identified the number of ground slots needed for each of the alternatives as shown in Appendix 4-1. The analysis also identifies the number and types of equipment needed in each case.

The following table presents a comparative summary of key storage capacity parameters for the four systems.

Table 5.2-1 Yard System Capacity Comparison of Alternatives

Terminal Capacity for Various Alternatives

	Units	Y1	Y2	Y3	Y4
		RTG	Wheeled	Top-Pick	Reach Stacker
			FGS		
Dry	TGS	1188	1385	1286	1147
Reefers	FGS	160	160	160	160
MT	TGS	1352	1282	1282	1282
OOG	FGS	40	40	40	40
Maximum Full Storage (TEU)		5152	3170	6830	6135
Maximum Empty Storage (TEU)		6760	6410	6410	6410

LEGEND

- MT Empty Boxes
- Reefers Refrigerated Boxes
- OOG Oversized Boxes
- TGS Twenty foot Ground Slot
- FGS Forty foot Ground Slot
- TEU Twenty Equivalent unit
- RTG Rubber Tire Gantry

The Consultant did not find any fatal flaws in any of these alternatives. Some alternatives such as the “Combination Wheeled + Top-Pick” system were land intensive and certain operational adjustments



would have to be made to address peak cargo throughput conditions. Others, such as the Reach-Stacker options, were not as familiar to the Port operating staff.

Upon completion of the analyses a comparative estimate of capital costs was developed. The results were discussed with the Port Management and Staff, Shipping Lines and other stakeholders as appropriate. PAG selected the "Combination Wheeled + Top-Pick System" as the preferred alternative.

5.5 Selected Alternative

Two variations of the Terminal Layout Alternative selected by PAG are depicted in Figures 5.5-1 and 5.5-2. The base variation (called Break-bulk East) in Figure 5.5-1 features placement of the Break-bulk Cargo Yard (shown in Cyan) in the newly developed expansion area to the east of the berths. The variation in Figure 5.5-2 (called Break-bulk West) shows the Bulk-Cargo Yard at the West end of the cargo terminal. Note that these arrangements are preliminary and for conceptual planning purposes only. The following sections describe the main features of the selected alternative.

5.5.1 Overview of Selected Alternative

The terminal layout concept was developed based on the Port's preferred terminal container handling system which is a combined "Wheeled plus Grounded" system as described below. The following are key features of the terminal design.

- A total of 2,250' of modernized berths for cargo handling
- Four container cranes to support efficient ship service
- Refurbishment and Use of the Current Container Yard for Storage of Wheeled and Grounded Containers
- Retention of the Port's 95 Existing Reefer Spots
- Retention of most of the larger existing buildings including the Admin Building, Warehouse Sheds #1 and #2, Maintenance Facility
- Expansion of the Cargo Yard into the Expansion Area to the East to offer more yard area for cargo storage
- Incorporation of a large expandable Break-bulk Cargo Yard to support base construction cargo
- Relocation of the Truck Gate to the East in order to implement an efficient modern gate design
- Incorporation of Visitor, Yard Chassis and Trouble Truck Parking
- Space for Accommodation of CIS, Customs, Agriculture Inspection and Fumigation Facilities
- Internal Terminal Area Access and Circulation Road at rear to minimize conflict with cargo handling operations in the yard and apron
- Moving activities and personnel not directly related to the cargo operation outside the terminal area
- Separation of Fishing Facility and Cruise Ship service outside the terminal with separate entrance
- Emergency Gates

A variation of the selected concept would locate the break-bulk yard to the West behind F-4 and F-5

The following sections provide more specific descriptions of the features of the concept.

Figure 5.5-1 Terminal Alternative - Break-Bulk EAST Variation

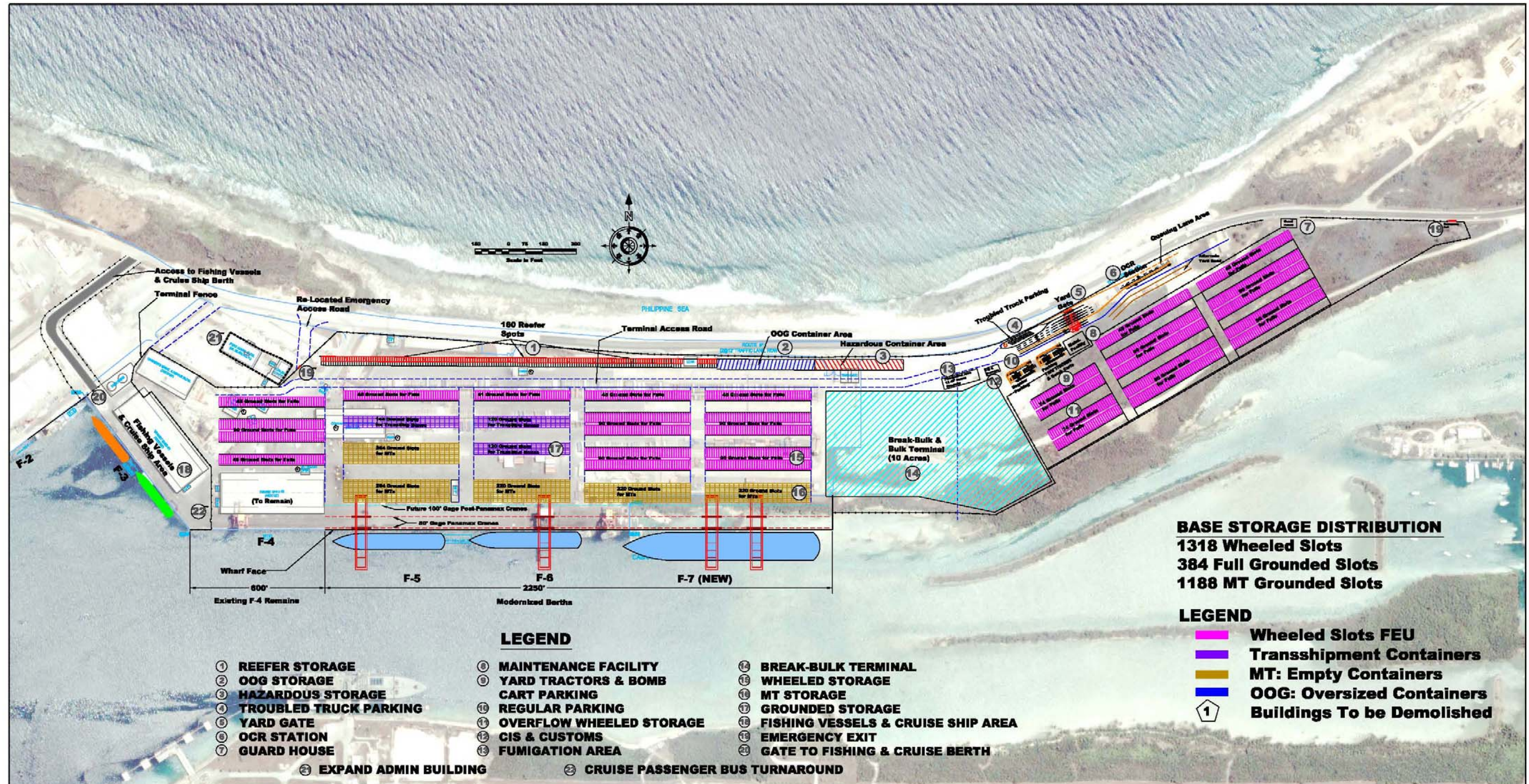
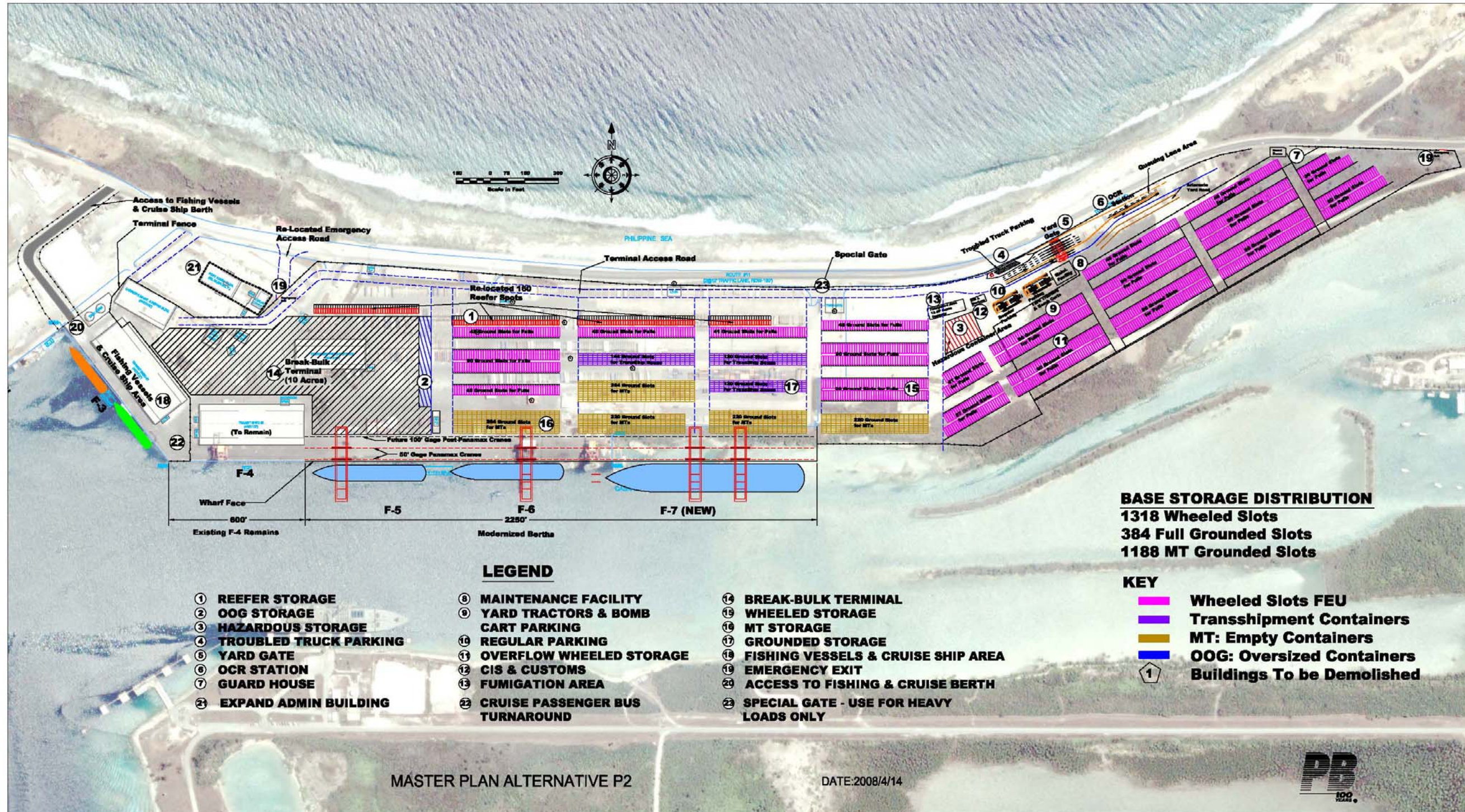

Figure 5.5-2 Selected Terminal Alternative - Break-Bulk WEST Variation



5.5.2 Cargo Berthing Facilities

Berth Arrangement & Depths

There would be a total of 2,250' of refurbished and new wharves provided as shown. A new F-7 wharf would be constructed east of the existing F-6 wharf. F-5 and F-6 will be refurbished with the Fender-line moved out about 3' and lined up with the new F-7 Fender-line. The condition and the type of design at the existing berths vary. Therefore different structural concepts such as those shown on a preliminary basis in Figure 5.5-3, 5.5-4 and 5.5-5 will be necessary to offer a modern berth to vessels over the entire 2,250' section. More details on the assumptions for capital cost estimates are provided later in Section 5.5.6 "Conceptual Basis for Wharf Modernization Estimates". In order to optimize existing structures and yet meet design vessel criteria the berth depths would be as shown on Figures 5.5-3, 5.5-4 and 5.5-5 and summarized below.

Table 5.5-1 Berth Depths after Modernization

Berth	Near-Term	Long-Term
F-4	No Change	No Change
F-5	-37'	-37'
F-6 (West)	-37'	-37' (Refurbished in 1998)
F-6 (East)	-42'	-51' (Eastern 415')
F-7	-42'	-51'

Note that the proposed Long Term Dredge Depth of -51' is consistent with the current 15.8m Apra Harbor Navigation Channel design depth.

Berth Utilization Analysis

A Berth Utilization analysis was performed for the berth configuration shown under the Peak Year 2015 when cargo flow is shown to be the maximum by the forecast in Section 4. The berth service performance was analyzed by each shipping route or service since factors such as ship size and quantity of cargo would affect performance.

Table 5.5-2 Cargo Berth Service & Utilization Analysis – Peak Year 2015 (Rev "Per Call")

Trade Route	Crane & Berth Service											Hours		
	Cargo: Peak Year 2015	Units	Vessel Calls	Per Call	Pilot / Arrival	Aver. Cranes / Ship	Crane Perf / Hour	Crane Service Hours	Dep. Hours	Aver. Berth Hours	Total Hours / Year	F-5	F-6	F-7
CNMI - Transhipment	3,672	Lifts	51	72	2	1.0	15	4.8	2	8.8	449	0	0	449
FSM/MI - Transhipment	7,280	Lifts	20	364	2	1.0	20	18.2	2	22.2	444	0	0	444
Asia Service	43,554	Lifts	122	357	2	1.0	20	17.9	2	21.9	2,666	0	2,666	0
USWC Matson/Horizon	135,450	Lifts	105	1290	2	3.0	22	19.5	2	23.5	2,472	0	0	2,472
Break Bulk Service	316,047	Tons	126	2,508	2	2.0	100	13.0	2	17.0	2,142	2,142	0	0
Total Container Cargo	189,956	Lifts								Occupancy Hours	8,173	2,142	2,666	3,365
Total Break-bulk Cargo	316,047	Tons								Berth Utilization %		25%	31%	39%

For the larger USWC vessels, the crane lifts were assumed to be an average of 22 per hour. A comparable figure for a USWC port with modern single-lift cranes is about 25 lifts/hour. However since in Guam incoming containers are placed on road chassis (as opposed to Yard Chassis) the average was adjusted down to 22. It was also assumed that crane service will consist of 3 cranes for most shifts. As can be seen from the average berth hours this will be necessary in order to service these vessels within a 24 hour period to help maintain their rotation schedule. The service rate for the smaller vessels were



adjusted down since the volume of cargo will be lower. Some vessels may also utilize their own gear or ship's cranes which can also slow performance.

The results show that F-5, F-6 and F-7 have berth utilizations of 25% 31% and 39%. This does not include lay berthing, bunkering and other incidental use by tugs etc. It is appropriate to limit total utilization to less than 50% especially at multi-user terminals such as PAG. This is because of impacts from difficulty of slotting outside the peak weekly hours, lack of control with multiple shipping lines and other similar issues.

5.5.3 Container Cranes

It was noted above that three-crane service would be required during peak conditions on the larger USWC vessels in order for them to maintain their rotation schedules. During this period it is anticipated that at least one other smaller container vessel will receive service concurrently. It is also prudent to have a fourth crane in case of breakdown. Considering these factors we recommend that the terminal be equipped with at least 4 container cranes.

PANAMAX vs. Post-PANAMAX Crane Service

As discussed in Section 5.2.1, Vessel Characteristics, the Consultant recommends that in the Near Term the facilities be designed for size of vessels up to the PMX Class of vessel. Long Term facility design should address accommodation of the highlighted PPMX vessels in Table 5.2-1.

For cranes service this means that the design should be able to service the vessels listed under each category. The PMX and lower size vessels stack containers 13 wide on deck whereas the largest suggested PPMX vessel would have containers stacked 18 wide on dock. Most of the PMX cranes in service today are designed to operate on rails at a 50' gage. Most of the PPMX cranes in service are designed to operate on rails at 100' gage. This is necessary for optimal design since the PPMX crane must reach further out past the fender line and must be designed to withstand larger overturning forces.

PAG does not need PPMX cranes in the Near Term but may need them in the Long Term as suggested by the design vessel characteristics. The cost of a new PPMX crane is typically about \$7.5 million each. PAG had recently obtained quotes as high as \$9.7 million for one PPMX crane. On the other hand there are a number of used PMX cranes available from other ports that are upgrading their capability to PPMX cranes. It is anticipated that there will be substantial savings in purchasing suitable used PMX cranes for PAG for the Near Term.

The Layout for the Selected Alternative was based on the ability to install 100' gage crane rails on the apron in the future to support PPMX cranes. Under this mode of operation, the ship hatch covers would be placed between and towards the rear crane rail during service. This leaves sufficient space between the hatch cover and the front rail to provide three access lanes (one for each yard gang service) plus an emergency access lane.

In the Near Term, the Port would install rails at a 50' gage and operate PMX cranes for berth service. Under these Near Term operating conditions the crane will place the ship's hatch covers behind the rear rail.

It is assumed that under both these conditions, the terminal will use single hoist cranes which are deemed to adequate considering the level of service.

5.5.4 Combined Wheeled + Grounded Operation

The Port selected the combined Wheeled plus Grounded container terminal operation for implementation. The selected alternative is based on the following assumptions for handling containers. Under normal or median volume operating conditions the following will apply.

Note: The description is for concept level planning purposes only. Actual handling system and operations may vary depending on Terminal Operator preference.



Wheeled Operation

The following types of full container cargo will be “Wheeled”. A container unloaded from the ship will be placed directly on to a road chassis and secured to the chassis on the apron.

- Full Standard Containers arriving from the USWC.
- Reefer Containers
- OOG Containers (Out of Gage)
- Hazardous Cargo Containers
- Full Standard Containers arriving at terminal for loading onto Matson and Horizon ships

Import Containers

For import cargo, from the ship, the Container and Chassis are moved to the yard by the Terminal Operator’s Yard Tractor and parked in “Wheeled Slots” until the consignee’s trucker comes and picks up the container. Matson and Horizon will move the road chassis into the terminal on an as needed basis.

Export Containers

For the above described export containers, the road chassis and container will be delivered to the terminal by the consignee or freight-forwarder’s trucker and directed to the “Wheel Slot” for spotting until ship arrival. The terminal operator’s yard tractor will move the container and chassis to the apron for loading.

The wheeled slots are shown in magenta on the drawings. The following Wheel Slot areas (mostly 40’) are shown on the preliminary layout.

Standard Containers	Magenta (1,300+)
Reefer Containers	Red (160)
OOG Containers	Blue
Hazardous Container Area	Orange

The Top-Pick pile is shown behind the Empty Stacks in keeping with current PAG practice.

Land Area

The number of wheeled slots required to support peak demand conditions cannot be accommodated in the area immediately behind the apron. It will require development of the terminal expansion area to the east of the existing container yard as shown.

Grounded Top-Pick Operation

The following types of full container cargo will be “Grounded” and handled by Top-Picks at the terminal.

- Standard containers arriving for transshipment
- Standard Asian service containers

For incoming cargo, the containers unloaded from the ship will be placed on Yard Chassis. The Container and Yard Chassis are moved to the yard by the Terminal Operator’s Yard Tractor. Top Picks operated by the terminal operator will remove the container from the yard chassis and store them in lots stacked maximum five high.

Inbound Guam Cargo

For inbound containers, when the consignee’s trucker comes to picks up the container he/she will go to the pile as directed at the gate. A top pick will remove and place the container on the trucker’s road chassis. The trucker will secure the container onto the chassis for transport out of the terminal.

Outbound Full Asian Service Containers

The reverse process to that described above will apply for full outbound Asian Service containers.



Transshipment Cargo

When the transshipment vessel arrives, the Terminal Operator's equipment (Top Pick, Yard Tractor and Yard Trailer) will be used to move the container from the storage pile to the apron for crane service and stowage in the ship.

The Grounded Top-Pick slots for normal operation are shown on the drawings as follows.

Standard Full Containers Pattern Shown	Purple (384 TGS shown) 3 Wide x 5 high back to back
---	--

Grounded Side-Pick Operation

The following types of containers will be "Grounded" and handled by Side-Picks at the terminal.

- Standard Empty Containers

Empties from Guam

Empty containers arriving from Guam on road chassis will be directed to the appropriate Empty Container Pile at the gate. Upon arrival at the unloading point, the trucker unlatches the container from the road chassis. The Terminal Operator will use a side pick to remove the container and store the container in the pile. Empty containers will be segregated by shipping line.

Transshipment Empties

Empty transshipment containers will be transferred from the apron to the appropriate empty storage pile by the Terminal Operator's equipment (Yard Tractor, Yard Chassis & Side-Pick).

Empty Containers for loading onto ships will be transferred from the appropriate empty storage pile to the apron for loading by the Terminal Operator's equipment (Yard Tractor, Yard Chassis & Side-Pick).

The Grounded Side-Pick slots are shown on the drawings as follows.

Empty Containers Pattern Shown	Orange (1188 TGS shown) 5 high block stow
-----------------------------------	--

The empties are shown near the apron in keeping with current PAG practice.

5.5.5 Flexibility for Extreme Demand Conditions

For the "Wheeled plus Grounded" operation it is likely that under certain extreme operating conditions the number of Wheeled Slots for full Guam import cargo will not be adequate. The conditions that may cause this may include one or more of the following.

- Extremely high weekly shipments arrive on the USWC carriers.
- Slow turnaround of chassis from Consignees and Freight Forwarders in Guam.
- Insufficient Matson and Horizon chassis available in Guam to meet peak cargo flow conditions.
- Larger than the 10 acres of land for break bulk is needed due to high flow of project cargo.

Another critical consideration is the presumed framework for deriving the Consultants' forecast. DOD base contractors in Guam are confident that it would not be economically feasible to precast housing modules off island and ship them to Guam in break-bulk form. According to these contractors, aggregate quarries in Guam can and will be expanded to support the construction. If this were not the case the volumes of cement imports would go down and the volumes of break-bulk cargo would go up substantially.

Therefore if the combined "Wheeled plus Grounded" system of operation is implemented we recommend the following be adopted as a contingency plan.

The entire yard area behind the apron showing wheeled slots up to the interior access road should be designed to stack containers using Top-Picks. Under peak demand conditions, the Top-Pick piles would be expanded east into the Wheeled Slot area so that more containers can be grounded and stored in a



denser fashion. The Wheeled Slot paving at the east of the expansion area may be designed for lighter tractor and chassis service.

5.5.6 Conceptual Basis for Wharf Modernization Estimates

The following Figures 5.5-3, 5.5-4 and 5.5-5 depict concepts that were used to assess capital costs for the modernization program. As discussed previously in Section 2, a portion of the wharf was re-built in 1998 after severe earthquake damage in 1993. The section is in good condition but consists of a different type of structure than the remaining sections. The remaining sections which are in poor condition are highlighted in green. The dark blue section represents the new F-7 section which will have to be constructed using yet a different type of design. Preliminary concepts were developed for each of these segments for the purpose of estimating capital costs.

5.5.7 Demolition

As depicted in Figure 5.5-1, the following significant building and structures would have be demolished in and current functions in these areas relocated in order to accommodate the above described selected master plan concept for modernization.

- Container Freight Station Building and adjacent tower
- Entrance Gate Canopy
- Building currently house the Harbor Police
- Site Concrete Apron, Light Poles, Fence and existing Truck Gate Building
- Miscellaneous Wharf Appurtenances

The estimated costs for demolition of these items have been included in the Capital Cost Estimate for the Selected Concept presented in Section 5.6.

Figure 5.5-3 Wharf Concept for Capital Cost Estimates at New F-7 Area

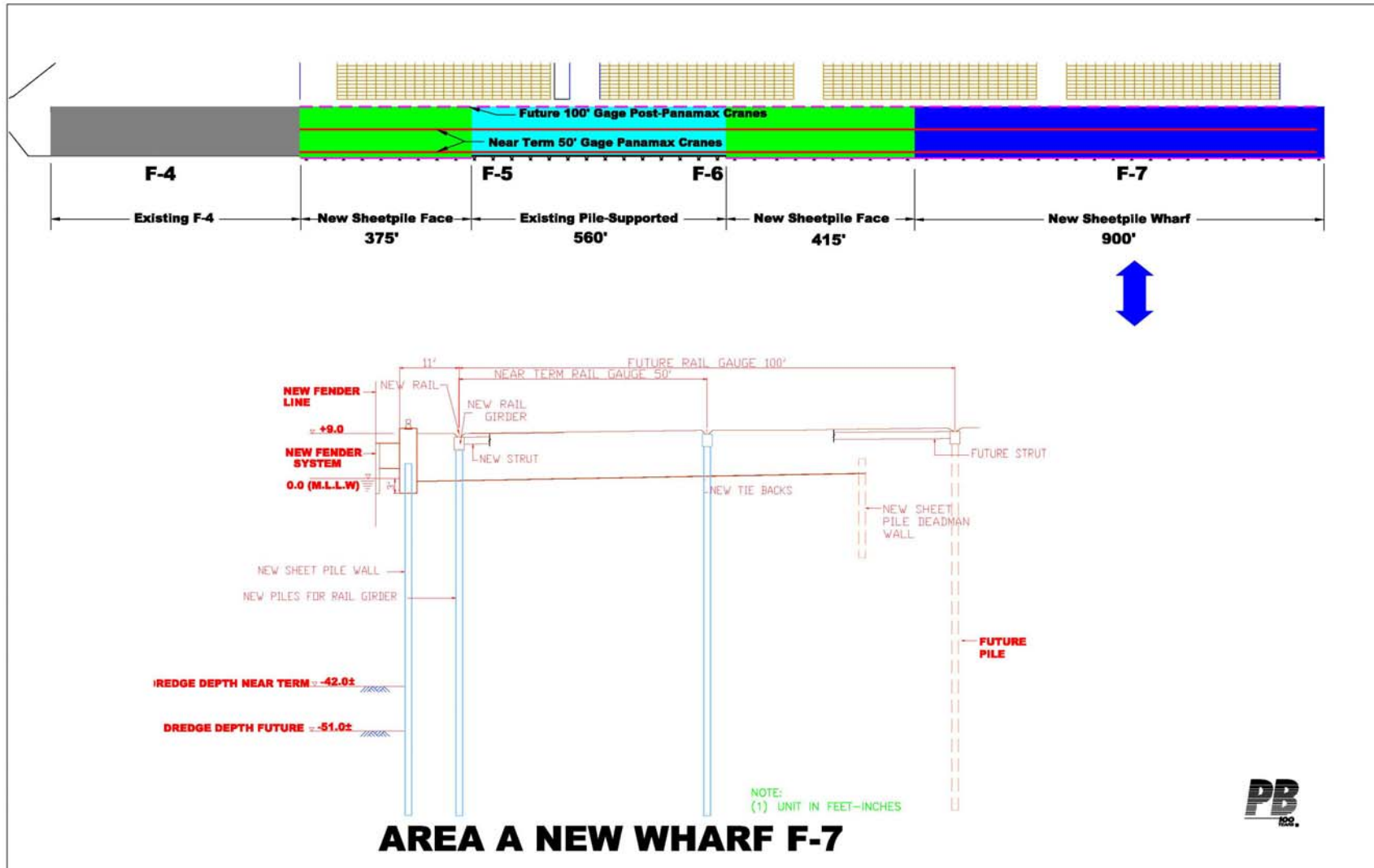

Figure 5.5-4 Wharf Modernization Concept Assumed for Cost Estimates for Area B

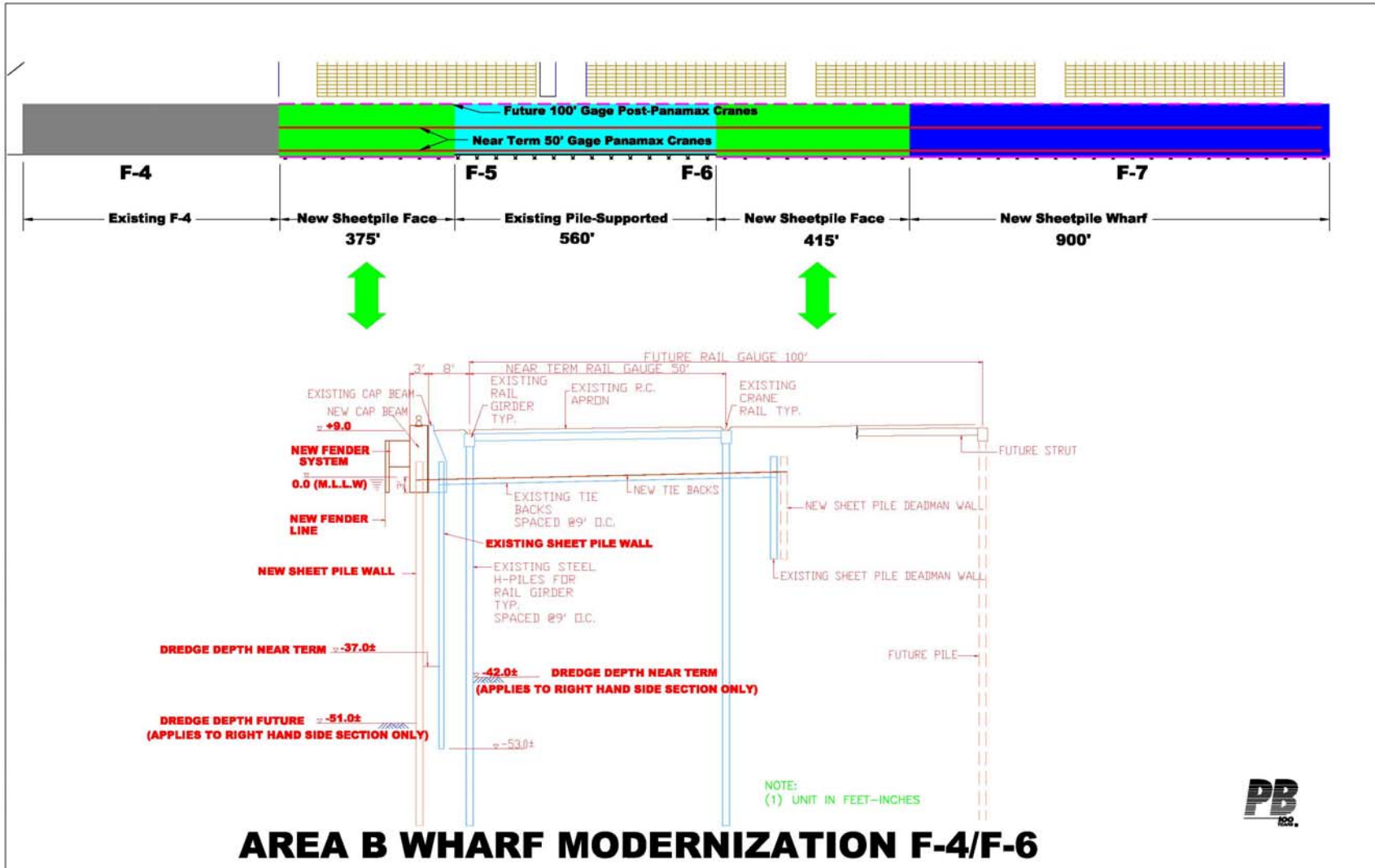
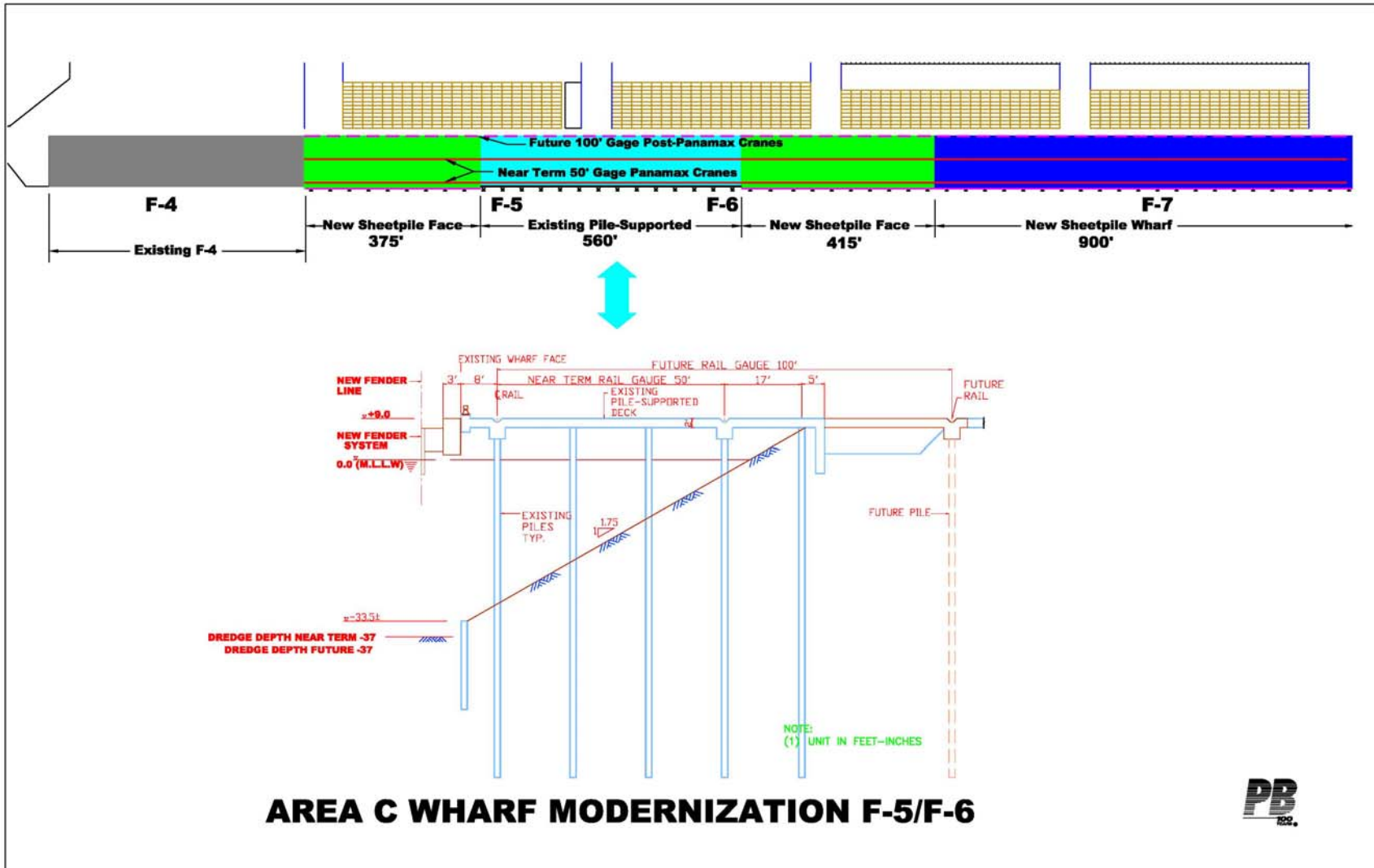

Figure 5.5-5 Wharf Modernization Concept Assumed for Cost Estimates for Area C



5.6 Capital Cost Estimates for Selected Concept

Capital cost estimates for construction and commissioning of the facilities, equipment and amenities that are required to implement the preferred concept described in this report were prepared on a conceptual basis. The estimate of Capital Costs by Major line item is presented below.

ITEM DESCRIPTION		Budget Estimate
Mobilization and Demobilization		\$ 6,640,000
All Other Contract Work not stated below		\$ 2,180,000
Demolition		\$ 7,510,000
Berth F-5 to F-7 Modernization		\$ 34,290,000
Buildings		\$ 7,950,000
Terminal Paving		\$ 14,600,000
Power, Lighting & Electrical		\$ 10,280,000
Site Utilities		\$ 20,110,000
Security		\$ 7,740,000
Container Cranes		\$ 14,500,000
Top-Picks & Spreaders		\$ 2,900,000
Side-Picks		\$ 1,500,000
Other Yard Equipment		\$ 3,700,000
Terminal Operating System		\$ 2,500,000
Gates		\$ 2,500,000
		\$ -
CAPITAL COST ESTIMATE TOTAL		\$ 138,900,000
Contingency	25%	\$ 34,900,000
Engineering/Permits/CM	15%	\$ 21,200,000
TOTAL		\$ 195,000,000

The above estimate includes all costs related to facilities that would normally be provided within a Commercial Cargo Terminal by the Port and Terminal Operator. Facilities and equipment normally provided by State (other than PAG) or Federal agencies are not included. These would include CIS, Customs Building and Scanning Equipment, Agriculture Inspection and Fumigation Facilities and other inspection and enforcement facilities. The estimate is also based on the acquisition of three used PMX Cranes as discussed in this report. Financing costs such as prepaid interest and any fees associated with acquisition of Federal funds or Private or Bond financing are also not included in the above estimate.

5.7 Federal & Local Permit and Approval Requirements

5.7.1 List of Anticipated Federal & Local Permits

It is anticipated that the following environmental permits and approvals will be required to implement the Recommended Development:

Federal Permits and Approvals:



- National Environmental Policy Act (NEPA) completion
- US Army Corps of Engineers (USACE) Section 10/404 Permit

Local Permits and Approvals:

- Guam EPA (GEPA) administered Section 401 Water Quality Certification
- Guam Bureau of Statistics and Plans (BOSAP) Coastal Zone Management Program Consistency
- Guam Development Permit (if dredging seaward of the mean high water (MHW) line)
- GEPA Erosion Control Plan Approval/Permit
- GEPA Environmental Protection Plan (EPP) Approval
- GEPA administered National Pollution Discharge Elimination System (NPDES) storm water general permit for construction activities
- GEPA Test Boring Permit
- GEPA Dewatering Permit (if needed)

5.7.2 Federal Regulations Governing the Recommended Development

Construction of the Recommended Development will require compliance with the following federal regulations:

- Clean Water Act (CWA) (Sections 401, 402, 404)
- Rivers and Harbors Act (Section 10)
- Coastal Zone Management Act (CZMA) (Section 307)
- Endangered Species Act (Section 7)
- Fish & Wildlife Coordination Act
- Magnuson Stevens Act
- National Historic Preservation Act (Section 106)
- Federal Clean Air Act (CAA)
- Migratory Bird Act

If contaminated soil, sediment, or groundwater will be encountered during construction of the recommended development, the following federal regulations may be applicable depending on the characterization of the materials:

- Resource Conservation and Recovery Act (RCRA)
- Comprehensive Environmental Response Compensation and Liability Act (CERCLA)
- Toxic Substances Control Act (TSCA)

5.7.3 Local Regulations Governing the Recommended Development

Construction of the Recommended Development will require compliance with the following local regulations:

- Guam Water Quality Standards
- Guam Coastal Zone Management Program Policies
- Guam Environmental Protection Act (Public Law 11-191)
- GEPA Soil Erosion and Sedimentation Control Regulations
- Chapter 49, Title 10 of the Guam Code Annotated (GCA), (Air Pollution Control Act (P.L. 10-74))

5.7.4 Description of NEPA and the Permit and Approval Process

NEPA Process

Federal actions such as the issuance of USACE permits and federal funding will trigger the Recommended Development's requirement to comply with the National Environmental Policy Act (NEPA). NEPA establishes national environmental policy and goals for the protection, maintenance, and enhancement of the environment, and provides a process for implementing these goals within the federal agencies. NEPA



also established the Council on Environmental Quality (CEQ) which oversees NEPA. The NEPA process is separate from the permitting process but must be complete before permits can be issued.

NEPA requires full consideration of the environmental consequences of major federal actions including their alternatives, and its vehicle to do so is the environmental impact assessment (EIA) or environmental impact statement (EIS). A federal agency prepares an EIA to determine if a federal undertaking would have a significant effect on the environment. The federal agency issues a Finding of No Significant Impact (FONSI) if the action is determined to not have a significant effect on the environment, thereby ending the NEPA process. The FONSI can include measures to mitigate potentially significant impacts. If the action is determined to have a significant effect on the environment, the agency prepares an EIS. An EIS provides a more detailed assessment of the potential for an action and its alternatives to have a significant impact on the environment. An EIS also provides for public, agency and other interested parties involvement through the scoping process and review and comment on the draft and final EIS. After the Final EIS has been prepared, the agency issues its findings, ending the NEPA process.

Per Executive Order 96-26, GEPA has established minimum requirements for EIAs. These requirements are found in the *Guam Environmental Protection Agency Environmental Impact Assessment Guidelines*, September 1997 and amended in November 1999. The GEPA Planning and Review Division determines the completeness of the scope of the EIA and is responsible for reviewing the EIA document. GEPA also may require an EIS rather than an EIA. A meeting with GEPA would be held at the outset to discuss the Recommended Development, alternatives to be considered and a draft outline of the EIA.

Permitting Process

A USACE Honolulu District Section 10/404 Permit Application would be prepared and submitted to the USACE. The GEPA form, Form 401-C, would be prepared and submitted to the GEPA. The USACE and GEPA would review the application and form respectively, for completeness first and then review and comment. The National Marine Fisheries Service (NMFS) and US Fish and Wild Service (FWS) also would review and comment on the USACE application. The USACE would issue the Section 10 and 404 Permits and the Guam EPA would issue the Section 401 Water Quality Certification.

During the EIA process, the scope of the technical studies which accompany the permit applications would be discussed with the USACE and GEPA. In this way, the technical studies, as well as any field sampling and analysis, to be performed for the EIA would be prepared to the level needed for the permit applications. Involving the agencies early and gaining their concurrence, as well as conducting the EIA studies to the level needed for the permit applications will expedite the permit and approval schedule.



Section 6 Recommendations

Based on the above described analysis and findings the Consultant presents the recommendations presented in this Section 6 for further development of the Jose D. Leon Commercial Port of Guam by the Port Authority of Guam.

This Master Plan Update was performed for a planning horizon of 20 years with the start year of 2008. Within this planning horizon for the purposes of making recommendations for development of facilities and equipment it is important to differentiate between recommendations driven by a near-term requirement and a long term need that may be subject to events and conditions that occur in the future.

Because of such intangibles the Consultants recommendations will use the following terminology for near term and long term recommendations.

Near Term July 2010 Based on Military's estimate for base construction start.

Long Term Occurs some 10 to 15 years into the planning horizon.

Where a recommendation does not specifically state "Near Term" or "Long Term" the recommendations applies to the Near Term.

It is also important to reiterate that the nature of planning requires that updates be performed in the future from time to time in or to validate and refine the recommendations made and address developments that cannot be forecast at this time.

In making recommendations for development of the Commercial Cargo Port and environs our recommendations are strongly driven by the upcoming relocation of the military bases from Okinawa, Japan to Guam and the resulting anticipated demand for cargo throughput and economic activity that it will bring to Guam.

6.1 Cargo Terminal Modernization

We recommend that the Commercial Port Cargo Terminal on Cabras Island be modernized and expanded in its current location to address the increased cargo throughput anticipated over the planning horizon. The facility improvements should be designed to support the following minimum annual cargo throughput volumes.

Containers / Year	200,000 Lifts
Break-bulk Cargo / Year	350,000 Tons

Recommendations on the need for expansion of Cement unloading are presented later in this section. We do believe that with proper maintenance and upkeep there are sufficient liquid fuel unloading capabilities available in Commercial Port area.

6.1.1 Terminal Land Area

We recommend that the current terminal areas and the designated cargo terminal expansion areas be utilized for this modernization program. This would encompass the area designated "CT" in the current land use map shown on Figure 2.1-2, Section 2.

6.1.2 Berth Modernization

We recommend that a minimum 2,250' of refurbished and new wharves be constructed at the terminal as shown in Figures Figure 5.5-1. This would consist of a 900' new Berth F-7 wharf located east of the existing berths and refurbishment and modernization of 1,350' at existing Berth F-5 and F-6. We recommend that Berths F-2, F-3 and F-4 be provided proper maintenance and upkeep for use by smaller vessels. The following berth depths are recommended.



Berth Depths after Modernization

Berth	Near-Term	Long-Term
F-4	No Change	No Change
F-5	-37'	-37'
F-6 (West)	-37'	-37' (Refurbished in 1998)
F-6 (East)	-42'	-51' (Eastern 415')
F-7	-42'	-51'

The above metrics should provide one contiguous 1,315' berth at the East end of the terminal that would be dredged to -42' in the Near Term and designed for -51' in the Long Term.

The current 15.8m Apra Harbor Navigation Channel design depth designation should be maintained to support these Long Term berth needs.

6.1.3 Design Vessels

We recommend that the berths be designed to support the following minimum representative design vessel sizes.

Short Term Minimum Design Vessels

Classification	TEU	LOA (Feet)	Draft (Feet)	Beam (Feet)	Width (Container)	DWT
Handy Size	2,200	640	33	93	11	25,000
Maunawili	2,600	712	41	105.6	13	37,752
Horizon Hunter	2,824	729	39	98	12	39,266
LMSR Military Vessel	N/A	950	37	105.6	N/A	34,000

Long Term Minimum Design Vessels (Applies to F-6 East & F-7 only)

Classification	TEU	LOA (Feet)	Draft (Feet)	Beam (Feet)	Width (Container)	DWT
Post Panamax	4,800	900	45	135	16	90,000
Super Post Panamax	8,000	1,150	48	150	18	100,000

6.1.4 Ship to Shore Container Cranes

We recommend the acquisition and installation by purchase, lease or other third party supply agreement three (3) used PANAMAX Cranes (PMX Cranes) in good condition in the Near Term. Upon acquisition of these cranes, we recommend the scrapping and removal of the two older cranes leaving the existing "Subic" crane in order to offer a total of four (4) cranes for berth service.

The crane rail system should be upgraded to support these 50' gage PMX Cranes for the Near Term. We also recommend that the three used PMX-Cranes that are purchased be powered by electrical power and not be converted for diesel power. ⁶We recommend the installation of a backup power generation system capable of supporting critical Port operations in order to address power outages.

Note that one of the two currently operating cranes is in bad condition and prone to breakdown. We recommend replacement of this crane immediately with at least one of the three used PMX Cranes discussed above.

We recommend developing the berth apron and adjacent area to support the use of 100' gage Post-PANAMAX Cranes (PPMX Cranes) in the Long Term. These new cranes would be purchased and put into

⁶ We understand that the Port will not be installing shore power for additional 50' gauge gantry cranes but would consider this only in the Long Term when 100' gage Post-PANAMAX (PPMX) cranes are deemed to be necessary. We understand that cranes identified for immediate acquisition will be converted to diesel power for use at the PAG terminal.



service at the appropriate time to service the Long Term Design Vessels described in the previous section.

We recommend that the yard design behind the rear crane rail be planned for the above referenced 100' Post-PANAMAX Crane rail gage. However because of the narrow configuration of the terminal, no space behind the rear 100' gage rail need be provided for temporary stowage of ship hatch covers as is customary in some terminals. The PPMX-Cranes should be ordered to support placement of hatch covers between the 100' gage crane rails in the future. Other current trends in PPMX features such as the ability to handle 53' containers, tandem or twin lifts etc. should be reviewed and considered at that time.

6.1.5 Cargo Storage Yard & Configuration of Terminal Area

We recommend reconfiguring the terminal area to relocate all activities and personnel not directly required for cargo handling operations to a location outside the terminal fence. One conceptual configuration is depicted on Figures 5.5-1 and 5.5-2. Tenants with non-essential functions such as Fishing Industry operations and cruise vessel calls would have a separate access at the west end of the terminal. The Admin Building, Warehouse Sheds #1 will be located outside the fence. Specific recommendations for securing this terminal are presented later in this section.

We recommend the refurbishment of the existing yard area behind the berths as for cargo storage to meet modern cargo handling requirements. This will include upgrade of the pavement as well as all new utilities and high mast lighting. We recommend relocating the existing fuel line running through the terminal to an appropriate routing outside the cargo yard.

The currently vacant expansion area to the east should be developed to support terminal cargo storage requirements. This will include paving and all utilities and lighting for operation as a cargo storage yard.

A new truck entry and exit gate should be constructed in the expansion area generally as shown in Figures 5.5-1 and 5.5-2. Other facilities and amenities that should be included within the cargo terminal fence include the following:

- Reefer Container stations
- Hazardous Container Storage Area
- Out of Gage Container Storage Area
- Incorporation of a large expandable Break-bulk Cargo Yard to support base construction cargo
- Visitor, Yard Chassis and Trouble Truck Parking areas
- Space for Accommodation of Customs, Agriculture Inspection and Fumigation Facilities
- Internal Terminal Area Access and Circulation Roads
- Emergency Gates

In order to accommodate configuration changes, we recommend demolition of certain existing buildings and relocation of functions currently performed from these buildings to another area. The proposed structures for demolition are identified in Figures 5.5-1 and 5.5-2.

Between the two terminal master plan alternatives, Break-Bulk East (Figure 5.5-1) and Break-Bulk West (Figure 5.5-2) terminal users generally preferred the Break-Bulk West configuration. The Break-Bulk West alternative will be about \$2 Million more costly due to the need for relocation of LC#4 and the wheeled refrigerated container slots. However we concur that the Break-Bulk West alternative will result in a more efficient operational arrangement. The Capital Cost Estimate presented in Section 5.6 was based on the Break-Bulk West alternative shown on Figure 5.5-2.

6.1.6 Container Handling System

The container handling system selected by PAG for further planning and the one preferred by the USWC shipping lines is a combination "Wheeled" and "Grounded" system akin to the current operation. Generally full containers from the USWC would be stored in the yard by placement on road truck chassis. Other containers will be handled by Top-Picks, Side-Picks and Yard Tractor/Trailers and stored in piles in



the container yard. The Consultant's recommendations linked to yard design were therefore developed on the basis of the above container handling system.

Public Law 27-60 and Public Law 29-23 allow for the Port Authority of Guam to either enter in a contract with a terminal operator or enter into a public private partnership through a performance management contract for the management, operation and maintenance of the port cargo handling equipment and/or facilities associated with such equipment and/or other aspects of port operations. . . It should be mentioned that if this were to take place, such terminal operators or private partners often have a preference for a particular type of container handling system. This can significantly change the yard area and requirements. Some terminal operators may wish to invest in their own cargo handling equipment (normally excludes the ship to shore container cranes) as part of the operating agreement. Depending on the timing and identification of a terminal operator and equipment preference some recommendations in this Section 6 may not apply.

During final design of the terminal and implementation of the container handling system and arrangement, consideration should be given to a suitable plan for taking into account the typhoon level weather conditions that can affect the Port of Guam.

6.1.7 Yard Flexibility for Extreme Demand Conditions

For the "Wheeled plus Grounded" operation under certain extreme operating conditions the number of Wheeled Slots that can be accommodated in the terminal area may not be adequate. The conditions that may cause this may include one or more of the following. These conditions could include peak shipments arriving the same week, turnaround of Shipping Line chassis in Guam, insufficient chassis availability, higher than anticipated peak demand for break-bulk project cargo during base construction.

Therefore we recommend that a portion of the "Wheeled Chassis" storage areas be designed for stacked heavier container storage equipment loads so that these areas can be used as stacked container storage areas under these peak conditions.

6.1.8 Truck Gate

We recommend implementation of semi-automated gate design that can process container trucks in a fast efficient fashion. Target design time for container truck processing should be as follows:

Target Inbound Truck Processing Time	180s
Target Outbound Truck Processing Time	60s

This will require several facility and system features in order to incorporate and maintain. While final design will depend on a number of issues for discussion with the Port, Shipping Lines and Vendors during design implementation, it is recommended that the following features are considered, analyzed and adopted as needed.

- Purchase of recognized and proven gate processing system
- Electronic transfer of documents between the terminal and the shipper or steamship line prior to arrival at the terminal.
- Optical Character Recognition (OCR) or RFID (as applicable for user or shipping line) before arrival at the gate to identify container number, type size code, IMO labels, seal presence and cameras for reading vehicle license number to verify that the truck is expected.
- Automatically read and verify electronic container seals.
- Cameras are used to identify container damage.
- Radiation scanners are used to scan for radiation.
- Gamma Ray scanner for checking empty containers. (option)
- Trucks are weighed to determine the weight of the container. (option)
- For certain types of PAG cargo highway limit requirements point to the need for a weigh scale.
- The driver scans an electronic identification card (ID card) that identifies the truck and / or driver.

- The driver enters the booking number on a touch pad screen and is given a slip that tells the driver where to go in the container yard.
- If there is a problem that is discovered at the verification station, the truck is directed to proceed to a trouble truck area to resolve the issue.
- Turnaround lanes for rejected trucks.
- Empty containers can be checked to determine if they are, indeed empty. This can be done by opening the doors or by using Gamma Ray scanning devices to be installed in the verification station.
- In addition, OOG (Out of Gauge) containers must be handled separately.
- Reversible gate lanes to address peak demand periods.

6.1.9 Minimum Equipment Requirements

For the Container Handling System assumptions discussed in Section 6.1.6, we recommend equipping the terminal with the following minimum list of equipment.

Equipment:	Ea.
Container Quay Cranes - Existing	1
Container Quay Cranes - Additional	3
Top Picks	5
Yard Tractors - Existing	8
Yard Tractors - Additional	17
Yard Chassis	50
Side Picks (Empties)	6
B/B Ship Cranes	2
Mafi Trailers	8
Forklifts 30T	1
Forklifts 10T	1
Forklifts 7.5T	2
Forklifts 5T	6
Shipper Supplied Chassis*	As Needed
*By S/L or Consignee	

Based on the demand cargo forecast presented in Section 4 and the selected container handling system, the above minimum list of equipment will be required for the entire planning horizon. Note that unless specifically labeled as existing, all other equipment would have to be acquired.

Note that the above minimum equipment requirements were developed for the selected Combination “Wheeled and Grounded” operation selected by the Port for implementation and described previously. Since it is the Port’s intent to handle the majority of the full containers moving through the terminal on chassis’s using a “Wheeled” operating concept the volume of full grounded containers is not high. The equipment selected for handling this smaller proportion of containers are Top Picks which provide more flexibility and adaptability to varying operating conditions and demands than other types of equipment systems for handling grounded containers. Accordingly under the Combination “Wheeled” and “Grounded” mode of operation selected by the Port for implementation RTGs have not been included in the above minimum equipment list.

6.1.10 Terminal Operating Systems

It is recommended that the Port transition to a proven vendor-furnished Terminal Operating System compatible with systems used by major shipping lines and terminals. These would include.

- Terminal Management and Operating System with Invoicing System
- Integration or Interface a Financial Management System and
- If preferred by the Port a Maintenance Work Order System (Equipment and Building)
- Gate Automation System



6.1.11 Labor Availability & Productivity

The capacity planning and analysis for developing the recommendations in this report were based on the ready availability of trained labor to address peak cargo handling operations. We therefore recommend that PAG set up an organizational scheme that can furnish skilled labor for the various tasks and activities at the modernized PAG terminal and meet peak demands. We also recommend that professional training be provided to the various categories of skilled labor in order to operate using new technologies, procedures and equipment consistent with a modern container terminal.

6.1.12 Separate Access for Non-Cargo Related Operations

Terminal layouts in Figures 5.5-1 and 5.5-2 show a separate terminal access for non-cargo related tenants at Berth F-3. It would very likely be necessary to renegotiate a strip of right of way along the Northeast edge of the CASAMAR lease property area in order to implement this and separate the non-cargo and commercial cargo terminal operations. As described below the above proposal will provide a separate entrance to the Fishing Industry operations at Berth F-3, Cruise Passengers and Warehouse #1. Access to the Commercial Cargo Terminal and Warehouse #2 will be through the new Truck Gate towards the east. We recommend that these facilities be separated as described.

6.2 Fishing Industry Operations and Warehouse #1 & #2

The Terminal Layout Design shown in Figures 5.5-1 and 5.5-2 demonstrate the viability of providing cargo handling facilities at the terminal without the need to include Warehouse #1 within the terminal boundary. A number of Long-liner Fishing support businesses are located in this building. The scheme also does not affect their berthing access to F-3. With the proposed new wharf extension the Port will have sufficient berthing at F-4, F-5, F-6 and F-7 to support commercial cargo terminal related vessel operations. Thus F-3 will become available for other non-cargo related uses.

Since the Cruise Vessel calls are not expected to increase dramatically in the Near Term, F-3 should be continued to be shared by these two types of users. Warehouse #1 will also be outside the Commercial Cargo Terminal area. Therefore we do not see the immediate need to relocate the Fishing Industry tenants in Warehouse #1 with commensurate under utilization of F-3 and Warehouse #1 and loss of revenue to the Port. Non-berth operations related businesses in Warehouse #1 should be relocated away from port area.

Warehouse 2 as shown is within the cargo terminal area is needed for certain types of break bulk cargo that requires covered storage during the Military Base construction program. We understand that it will also be needed to store sensitive military cargo that cannot be stored outside in the yard. Because of these reasons, we recommend that all operations in Warehouse #2 which are not directly related to cargo handling be moved outside the Commercial Cargo Terminal fence.

About half of Warehouse #2 is currently occupied by Port staff. The staff consists of a mix of some direct cargo related functions and a number of non-cargo related port functions. There are three Long-liner related tenants in Warehouse 2. We recommend that the non-cargo related Port staff and the Fishing Industry tenants in Warehouse #2 be moved outside the Commercial Cargo Terminal fence. The Port staff with direct Cargo related functions would remain in Warehouse #2. The vacated areas should be consolidated and converted for covered storage use.

It will be necessary to extend the existing Port Administration Office building to accommodate the Port staff moved out of Warehouse #2 and other Port staff displaced from buildings identified for demolition within the new Commercial Cargo Terminal fence.

In the Near Term, if feasible, the Fishing Industry tenants in Warehouse #2 should be given preference for relocation to Warehouse #1 (subordinated to Port needs) adjacent to Fishing Boat operations at F-3. However, if there is insufficient space in Warehouse #1, they would have to find space elsewhere.



In the Long Term, as demand for space adjacent to the container terminal becomes more valuable the Long-liner Fishing Industry operations should be relocated to Hotel Wharf as designated under the current master plan. Note that the CASAMAR lease is a long-term lease and is not affected by the master plan except for the strip of land that is needed for access as described in Section 6.1.12.

It is also important that adequate maintenance funds be allocated for maintenance of berths F-2 and F-3 during the 20 year planning horizon.

6.3 Cruise Vessels & Passenger Traffic

The Cruise Vessel traffic forecast is presented in Section 4. In the absence of substantial investment in a dedicated cruise call port, our forecast did not show substantial growth. Under these circumstances, it would be important to maintain and provide amenities to support the existing traffic and any incremental growth.

As described in Section 6.2, we recommend that in the Near Term the cruise passenger traffic and the long-liner Fishing Boat traffic share the F-3 Wharf and be segregated from Commercial Cargo Terminal operations. With this in mind the cruise vessel traffic access should be directed through the alternate entrance described above for long-liner fishing operations.

Space needs to be provided for a covered arrival area, customs and immigration protocols for the cruise traffic. In the absence of space in Warehouse #1 this function would have to be housed in a new prefab building or trailer to be located near the gate providing access to Berth F-3 (See Figure 5.5-1). This need should be considered when renegotiating property from CASAMAR for the Berth F-3 access road. Sufficient area Southeast of Warehouse #1 should be provided to support Tour Bus turnaround and parking during cruise vessel calls. However it is likely that for larger cruise vessel calls, buses will have to be shuttled in from an offsite parking area for passenger pickup and drop-off. Fishing industry operations would have to be suspended during Cruise Vessel calls as is the practice currently.

In the Long Term if Cruise Calls increase to a sufficient volume to economically warrant dedicated facilities, the Port should locate such a facility within the areas under its control for supporting oceangoing deep draft vessel traffic at that time.

6.4 Cement Unloading

The cement unloading demands during the base construction period will exceed the current capabilities in Guam for unloading this cargo. The capacities required and what is available at the Hanson Cement Unloading terminal is summarized below for both the low forecast and the high forecast scenarios.

Cement

	Low Forecast	High Forecast
□ Highest Throughput Yr 2006:	100,000	100,000 Tons
Est. Hanson Capacity	125,000	125,000 Tons
Peak Future Demand during Construction	250,000	500,000 Tons
	-----	-----
Shortfall in Peak Year	125,000	375,000 Tons

Note, the type and extent and the type of new construction both for the military and support infrastructure in Guam is not readily known at this time. For example refurbishment of existing buildings for use as base housing would result in lower cement usage and use of concrete highway construction for infrastructure modernization would increase cement usage. Since these variables are not readily apparent at this time it would be prudent to ensure that there is a base plan to cover the low or likely forecast and also a contingency plan if demand is much higher than anticipated. Note that as contracts are awarded for base construction and other infrastructure development projects the extent of cement demand will become more apparent.



Hanson Cement has indicated it is capable of increasing throughput up to 250,000 to 300,000 Tons/Year if their current unloading barge area dredge depth is increased. Additional dolphins, equipment and storage facilities would have to be put in place by Hanson. Under the low forecast scenario these facilities will be sufficient to address Guam's needs for cement during base and infrastructure development.

If cement needs are towards the high end of the forecast, this would leave a considerable shortfall. We recommend the following in order to address both contingencies.

We recommend reviewing the feasibility of increasing dredge depth at the Hanson unloading dock. If feasible this work should be done during construction dredging of the commercial cargo wharf (F-5 to F-7). This would better assure that the dredging is done at a reasonable cost as part of the much larger wharf project. A suitable adjustment in lease terms to pay for this is reasonable if appropriate under the terms of the agreement. This could be in the form of future wharf revenue to the port. This should be addressed in conjunction with an assurance of upland and unloading facility improvements to support the cement demands.

Under the high volume forecast scenario it may be necessary to attract a new cement supplier who would be located at the Seaplane Ramp property or Golf Pier for construction of an alternate cement supply point. Please note that there could be environmental permit ramifications with the Seaplane Ramp option depending on the extent of dredging required by the supplier. Section 6.5 below recommends certain land use designation changes consistent with such uses. The Golf Pier option would have to be compatible with and supplementary to the current lease agreement with Mobil for use as a fueling pier. The third option would be for Hanson to substantially increase capacity to support any high volume demand scenario.

6.5 Land Use & Zoning

The Existing land use environment around the Commercial Port area was described in Section 2.1.3. The current land use designations are presented in Figure 2.1-2, "Commercial Port & Vicinity Land Use Designations".

In addition to the recommendations described previously for addressing the Port's ongoing needs for the existing types of cargo the Consultant's assessment of the commercial port area showed certain additional deficiencies that should be addressed in order to support the long term waterborne transportation needs of the people of Guam. These deficiencies related to the availability of developable land immediately adjacent to deep navigable waters for oceangoing vessels for the movement of future cargo and waterborne transportation not supported by the existing terminals. Successful ports identify and reserve such land areas with access to navigable waters for uses that are critically dependent on access to deep draft navigation in order to serve the future needs of the community.

The Commercial Port area in Apra Harbor is the only area available in Guam for locating industrial facilities that are dependent on access to deep-draft marine transportation for their activities. With Dry Dock Island and other lands in Inner Apra Harbor no longer available for civilian development, there is little vacant land available for locating future marine dependent industrial facilities that may be critical for Guam's economy. During the course of our investigations we encountered proposals from private industry for development of such facilities but there was a dearth of suitable land with access to navigable waters. The Area designated "FC" for similar use on Figure 2.1-2 no longer has vacant land for development.

Our review showed that there is very little land available to the Port in Apra Harbor with access to deepwater, inland transportation links and minimal conflict with other critical uses that cannot be fulfilled elsewhere. There were only two areas that we were able to identify with these prerequisites. One was the area adjacent to Outhouse Beach, Golf Pier and Seaplane Ramp outside the ESQD zone with access to deepwater in Apra Harbor and Route 11. The amount of land currently available here is limited. The second area we identified was across Cabras Channel from the Container Terminal with access to Route 18.

Figure 6.5-1 Recommended Land Use Change

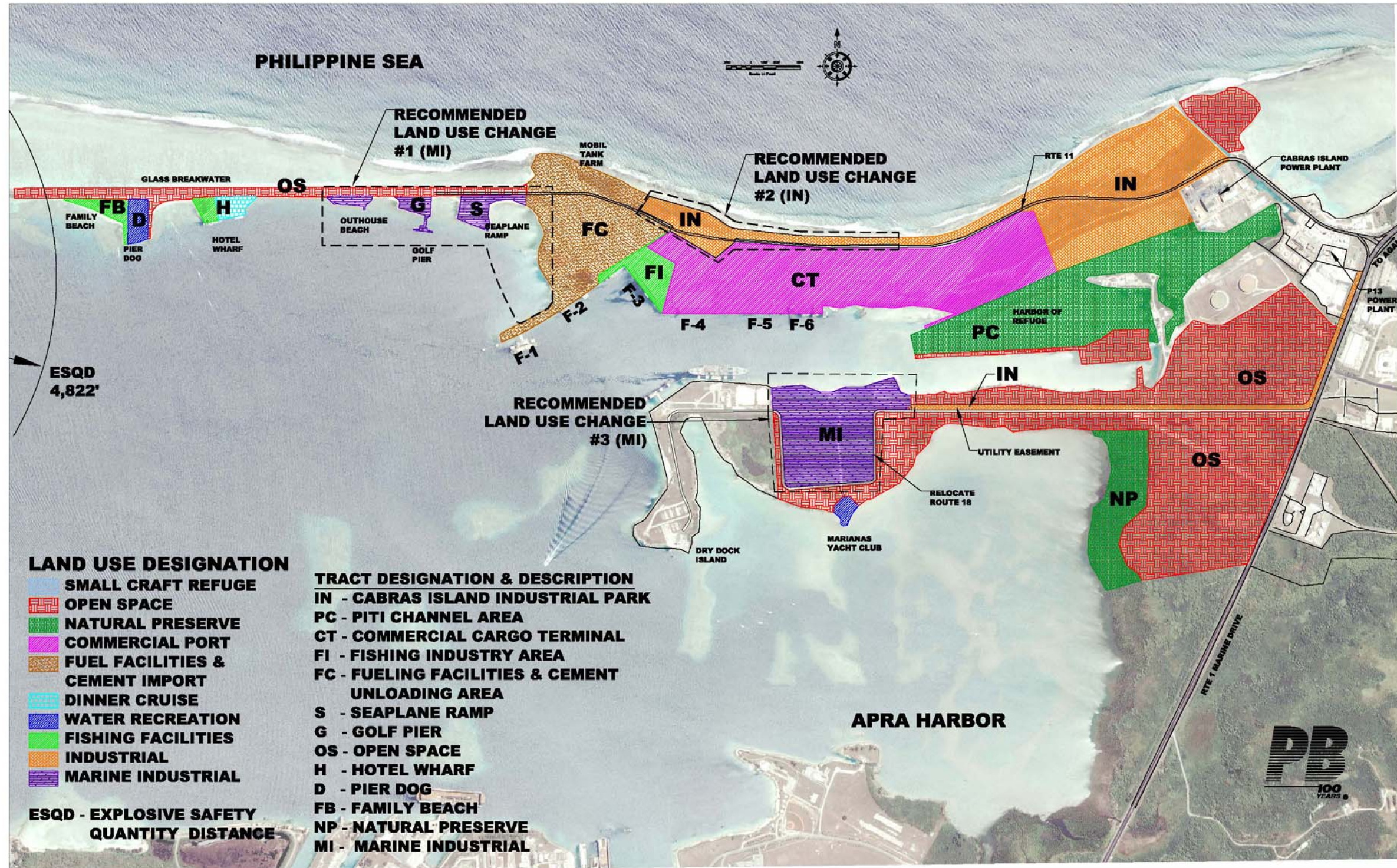
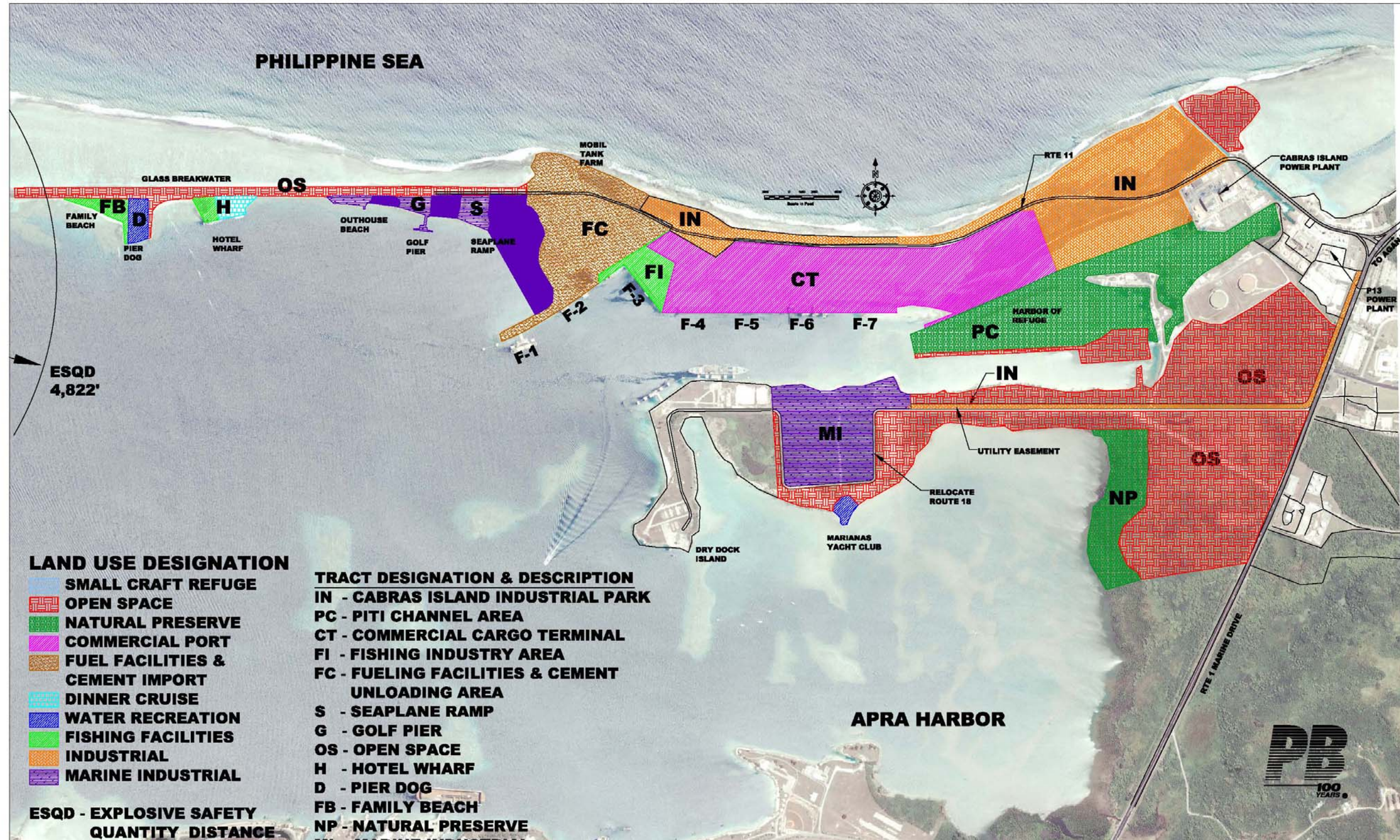

Figure 6.5-2 Creation of New Industrial Land



6.5.1 Recommended Land Use Changes

The Consultants therefore recommend the following port related land use changes to the land use plan adopted in 2000.

Marine Industrial Designation

In reviewing the current land use designations we noted that certain designations have been defined narrowly to support certain types of industries only. For example the designation "FC" applies to Fueling Facilities and Cement Unloading which presumably would not apply to other types of marine dependent industrial uses. We therefore recommend that the proposed land use changes described below under "Land Use Change #1" and "Land Use Change #3" and shown on Figure 6.5-1 as designated for "Marine Industrial" use encompass any industrial or commercial facilities that are dependent for their operation on access to deep-draft oceangoing vessels with associated water borne transportation needs directly to or from their facilities.

Land Use Change #1

We recommend that the land use for the area highlighted "Recommended Land Use Change #1" in Figure 6.5-1 encompassing Outhouse Beach, Golf Pier and Seaplane Ramp be changed to "Marine Industrial" use.

The Consultants further recommend that additional land be created on an opportunistic basis within this Marine Industrial Zone in locations where it is feasible from an engineering and economic perspective. Figure 6.5-2 illustrates one conceptual approach proposed in PAG's "Draft EIS for the Master Plan for Deep-Draft Wharf and Fill Improvement in Apra Harbor". Other feasible configurations within the framework of Federal and Local Environmental regulations should also be considered.

Land Use Change #2

We recommend that the land use for the designated area highlighted "Recommended Land Use Change #2" in Figure 6.5-1 be changed from "Open Space" to "Industrial". Industrial use of land along this area should be performed in conjunction with sound coastal engineering protection practice in order to shelter the road and port areas from storm wave conditions. This sets aside a contiguous area within the Commercial Port with more flexibility for fulfilling the needs of the various terminals.

Land Use Change #3

We recommend that the land use for the designated area highlighted "Recommended Land Use Change #3" in Figure 6.5-1 be changed from "Open Space" to "Marine Industrial" use. This change would relocate Route 18 to the south and around this zone in order to provide land adjacent to deep draft navigation in Cabras Channel. It is recommended that the alignment of Route 18 along the east boundary of the newly designated Marine Industrial area be located as shown including a buffer to the east of the new road in order to minimize the impact on existing wetlands along the eastern shoreline of this open space area. We also recommend setting aside a utility corridor adjacent to and north of Route 18 and West of Route 11 as shown to provide utility service to the newly designated area.

6.5.2 Other Land Use Designations Remain Unchanged

All other land uses in the vicinity of the commercial port would remain unchanged from the current designations adopted in 2000. The proposed activities to be permitted in the various areas are shown on Figure 6.5-1.

6.5.3 Conveyance of Ancestral Lands

In recent years there have been claims made by several heirs to the original landowners for certain properties now under port inventory. Specifically, these parcels front the Sasa Bay preserve. These lands, partially wetland, have sat idle for many years.

We understand that for the conveyance of unused PAG lands to ancestral property owners to occur, Section 818 of the U.S. Public Law 96-418, which governs the Quitclaim Deed that transferred current

Port lands from the Federal Government to PAG, must be amended. A draft resolution for adoption by the Board of Directors of PAG requesting the Governor of Guam and the Legislature to solicit Guam's Delegate to the U.S. Congress to introduce a bill to amend Section 818 of U.S. Public Law 96-418 was once considered but no record of adoption was available to the Consultants.

It is recommended that PAG review the status of these claims using appropriate legal and technical resources and adopt a policy that clearly states its position on the return of these unused ancestral lands. If PAG decides to convey such lands to ancestral property owners, it is recommended that it adopt a resolution requesting assistance from the Government of Guam and its representative in Congress to work for introduction of a bill for amendment of the said Public Law such that the conveyance of said property can occur. It is also then recommended that PAG work with the Ancestral Land Commission which is charged with returning lands to original land owners where appropriate.

6.6 Port Security

CONFIDENTIAL INFORMATION
NOT INCLUDED IN PUBLIC REPORT

CONFIDENTIAL INFORMATION
NOT INCLUDED IN PUBLIC REPORT

CONFIDENTIAL INFORMATION
NOT INCLUDED IN PUBLIC REPORT

CONFIDENTIAL INFORMATION
NOT INCLUDED IN PUBLIC REPORT

CONFIDENTIAL INFORMATION
NOT INCLUDED IN PUBLIC REPORT

CONFIDENTIAL INFORMATION
NOT INCLUDED IN PUBLIC REPORT

6.7 Marinas

The Port of Guam owns the three major public marinas and associated small boat harbors on the island of Guam. Together they provide opportunities for most of the public's small boat needs. However the condition of these facilities does not allow the public to benefit fully from their amenities. To make the most use of the facilities, they must be in good condition and provide the services appropriate to their location and existing layouts. All three marinas should be considered as a whole when making decisions on maintenance and improvements.

General Operational Improvements

A number of major improvements are necessary at these marinas in order to bring these on par with similar modern amenities in the country. With this as the benchmark we recommend that the following general operational improvements be made at these marinas.

- Improve and maintain safety to contemporary modern codes and standards.
- Improve and maintain security control including gates, lighting, restrooms and patrols.
- Standardize utility services at the floats.
- Provide reliable sanitary sewage disposal facilities at each marina.
- Place the management of marinas under the control of one marina manager.
- Provide timely response to tenant requests and complaints and maintain a log of all issues that are addressed.
- Prioritize capital improvements.
- Develop and implement a standardized slip vacancy filling procedure.

General Marina Rates

Marina Rate Recommendations include:

- Implement the rates proposed in the amended Marina Rules and Regulations of the Port Authority of Guam as adopted by the Port Authority Board of Directors on March 19, 2004 with the exception that the marina rates for the Gregorio D. Perez Marina should be the same as those proposed for the Agat Marina. While the condition of the Gregorio D. Perez Marina is poorer than that of Agat, it has a better location (proximity to the main business district) and the current slip demand far outweighs the supply. The rate increase for the marinas should be concurrent with capital improvements discussed herein.
- Open Space storage fees should be increased.
- Re-evaluate and increase the rate structure for commercial vessels. Commercial vessel rates at Gregorio D. Perez Marina should not be less than recreational rates at Agat.
- Businesses that use marinas for tourist related or other activities should be charged additional fees consistent with traffic and usage.

The following specific recommendations are made for each marina and harbor.

6.7.1 Gregorio D. Perez Marina

Gregorio D. Perez Marina is in the poorest condition of the three facilities. Safety repairs should be made immediately or the unsafe marina areas should be placed off limits to personnel until safety corrections are made. These areas include areas where the handrails have broken away from their concrete bases and the floating docks. The repairs needed to correct all discrepancies identified at the marina are so great that replacement, not repair, is recommended for the long term. The estimated cost of replacing the marina in the same configuration is approximately as follows:

Estimated Capital Costs: \$3.5 Million.

While the safety repairs stated in the condition survey need to be accomplished, the long term goal of the facility should not be to merely repair the existing facility "as is". As part of this replacement the marina should be expanded and reconfigured with a different mix of slip lengths and fairway widths. The marina should be a magnet for recreational, charter, and local fishing boats. The marina should emphasize and support the local recreational, tourist and fishing economy. Current law states that the marina should emphasize recreational uses. The language should be re-evaluated and changed to emphasis recreational, tourism and fishing equally. All are important to the local citizens of Guam.

A realistic expansion would include increasing the size of the West Basin by excavating and expanding to the west toward the sewage treatment plant access road. The fill area separating the East and West Basin should be excavated and removed. Parking and any required building structures should be relocated to an area west of the West Basin and border the Sewage Treatment Plant access road. The marina can then be reconfigured to optimize the boating use types and increase the number of boat slips

available. Heavy duty concrete floats with properly designed guide piles should be used. This type of marina float system can yield a 50-year life and sustain typhoon winds and accompanying tide surges. Concrete sheet pile walls in lieu of steel sheet piles should be used to enclose the basin. The two boat ramps can be replaced with one. Boat haul-outs for inspection, maintenance and repair should no longer occur here, but rather at a newly constructed facility at the Harbor of Refuge. Recreational design guidelines for ADA accessibility should be used. Security should be increased.

Estimated Capital Cost of Expanded Alternative: \$4.8 Million.

If the marina were in a condition that was comparable to Agat Marina, lease rates should be greater than that of Agat's due to Gregorio D. Perez's close proximity to the downtown area, tourist base and community activities. Unfortunately this is not the case so appropriate rates cannot be realized until improvements are made. Opposition to rate increases are understandable but higher rates are appropriate if the facility condition and/or location merits it.

Gregorio D. Perez Marina has great potential, but it will also cost the most to realize that potential. The marina should be improved and/or expanded with the funding coming from increased slip lease rates. Depending on the final configuration, rental rates, cost of improvements, financing framework and the demand some form of funding or subsidies maybe necessary.

6.7.2 Agat Marina

Agat Marina is the newer of the two marinas. It is located farther away from the downtown core than the Gregorio D. Perez Marina and has a greater capacity for recreational boats. In addition to recreational boats, charter boats use this facility to not only moor their boats, but to pick up passengers when wave conditions preclude charter trips outside of Gregorio D. Perez Marina. These two uses are appropriate for this marina. In addition, larger boats that cannot be accommodated at Gregorio D. Perez Marina are moored here. While this is an appropriate use, the facility is not currently designed to accommodate the mooring of heavy boats. These heavy boats cause damage to the floats and guide pile system and until the floats can be replaced to accommodate them, heavy and large boats should not be allowed to moor here. Heavier duty floats are needed for this use.

Recommended changes and improvements to this marina include the following:

- Replace existing slips at A dock with larger boat slips and floats that can accommodate larger and heavier boats.
- Remove sunken boats and chains attached to the breakwater.
- Improve security.
- Repair the refueling pier and boat ramp boarding piers.
- Dredge the marina, near D dock.
- Evaluate enclosing the boat basin by extending the existing breakwater around D dock and connect to shore. Water circulation within the marina must be taken into account and designed for. This is an expensive improvement and should only be undertaken if the marina occupancy increases above 80 percent.

The estimated cost of these improvements including extending the breakwater is estimated to be as follows:

Estimated Capital Cost: \$2.3 Million,

Due to the relatively good condition of the marina, the improvements could be prioritized and phased in over time.

6.7.3 Harbor of Refuge

The primary goal for the Harbor of Refuge is to provide a reliable shelter for non-trailerable boats from typhoons and other significant storm events. To that end the main goal is to provide secure anchorages that will not fail in the event that they must be used for that purpose. All anchorages should be inspected and those with obvious or questionable deficiencies repaired or replaced. A bathymetric survey

of the entrance channel and harbor should be made to verify that advertised depths can be achieved. Maintenance dredging should be performed as required. This must occur before other investments are made at this location.

This site should also be further evaluated for potential use as a location for an inspection, maintenance and repair facility. Located out of the main downtown district, this would allow activities that may not be consistent with tourist and recreational activities. There is a need on the island for a location to perform inspections and minor maintenance of boats. This location is preferred over the site currently being used at the Gregorio D. Perez Marina. A boat ramp can be installed at this location similar to what is currently in place at Gregorio D. Perez Marina. A user survey should also be performed to determine the demand for a boat haul-out facility. The haul-out facility could consist of a hydraulic trailer with mule or a mobile boat hoist. If the demand exists, both alternatives should be evaluated for feasibility.

Other areas of the harbor should continue to be leased out at appropriate market rates. Agreements should include sufficient language to hold lessees accountable to cleaning up their sites after their lease is terminated or expires so the Port does not have to cover these expenses.

6.8 Terminal Facilities & Buildings

6.8.1 Building Structures

Most of the buildings/structures in Port were built in year 1970, with the majority constructed using 3000psi concrete and 20,000psi reinforcement steel. The lateral forces in the design were dominated either by wind load or earthquake load. Shallow footings (spread type or strip type), with 1.5~3 ft. below the finish floor of 1st floor, were utilized to support the building/structures; the allowable soil pressure was designed based on 1100 to 2500 pound per square foot. The buildings appear to be acceptable for their current use subject to certain improvements discussed in this report. For such buildings constructed 35+ year ago, a code compliance check (especially seismic design aspects) is highly recommended. In addition the following is recommended.

A detailed inspection and estimate of costs for upgrading the various buildings was performed as part of security and hazard review by others within the last five years. Due to security considerations details from this document or its findings are not described in the report (See Appendix A1.3, Table A1.3-1, Item 123 for label only). However, the refurbishments recommended in this report should be performed and the buildings upgraded accordingly. The capital cost estimates for modernization of the terminal include estimated costs for these upgrades.

6.8.2 Facility Entrance

According to the Guam 2010/2020 Highway Master Plan, no short-term or long-term improvements have been recommended for Route 11, which provides sole-access to the Commercial Port. However, the Plan did not consider the volumes associated with the future military build-up. Yet, a remedial proposal was studied for protecting the Route 11 from wave run-up damage. Implementation was chosen by applying "Remove rocks & rubble AND construct a Single / Double Layer Revetment".

Only some minor cracks and ponding were found in limited areas on pavements of the container yard, Regular maintenance to correct the above described deficiencies is necessary. Significant corrosion was observed on the metallic part of gates and fences. Corrosion protection for metallic part of fences is recommended.



6.9 Site Utilities

Although a majority of the site utilities were basically established with the development of the Port since 1970's, upgrading of various equipment has been carried out (or will be carried out shortly) on most of the systems. The equipment reviewed in the field appeared to be in acceptable condition for current use with a few exceptions (e.g. the aged gate valves for the underground domestic water pipes and asbestos pipes). However, as site utilities have been modified or extended to cope with various extension stages of the Port, together with the change of use of some of the areas, certain underground utilities are no longer located at the best location for both operation and maintenance (e.g. water pipe serving areas outside the Port is running through the container yard of the Port). A full review on the utilities routings as a whole is recommended should major upgrades to the utilities be required. In addition, since some of the existing utilities (e.g. storm drain direct discharge to sea and mixed supply for fire water and domestic water) were designed to meet the codes or engineering practices some 35+ years ago, a code compliance check or review is highly recommended. For new service routes, they should be located as far as possible along the edges of the access roads and not be located under any of the container stacking areas.

Apart from the above factors, the site utilities need adjusting due to the changes and expansion in Port areas including the container yard, reefer areas, entrance, new buildings, etc. In addition, in view of the growing importance to maintain uninterrupted service for various Port activities, it is worth considering an upgrade to the security and reliability of the site utilities.

6.9.1 Electrical Services & Load Center

With the proposed extension of the Port towards the eastern site, a new Load Center (namely LC-5) would be required in the eastern area to provide power supply to the new buildings and container yard. Subject to final confirmation on detail design, the equipment capacity of LC-5 would at least be comparable with the existing LC-1.

With the expansion of the reefer areas, it would be too far for away for LC-4 to feed the reefer outlets at the western end. Also, additional equipment, including a step down transformer for 240V supply, would be required in other Load Centers. However, since LC-4 is closer to the reefer area and has spare space available to expand, the additional equipment is recommended to be installed in LC-4.

No major changes would be anticipated in LC-2 and LC-3, except the need to modify the low voltage distribution system to suit the changes in loads introduced by the demolition of certain buildings and the expansion of the container yard areas around LC-2 & LC-3.

As mentioned in Section 2.4.1 above, the power supply to the Port is tapped off from one single GPA 13.8kV overhead line along Route 11 outside of the port with limited capacity and shared use with other piers and facilities along the road. With the growing importance to maintain electrical power supply to the Port, enhancement on both the supply security level and flexibility for further expansion is recommended. A second 13.8kV main supply feeder should be applied with GPA to feed LC-5. RMU (Ring Main Units) should be installed in LC-1, LC-4 and LC-5 to form an open ring arrangement. In normal operation, LC-5 and part of the load from LC-4 would be supplied from the new main supply feeder while the rest of the Load Center (i.e. LC-1 to LC-3 and part load of LC-4) would be supplied from the old main supply feeder. By suitable changing of the switches positions of the RMUs, the supply to each of the Load Centers can still be maintained (although it may require the shedding of non essential loads depending on the available capacity limits of the main supply feeders from GPA) during failure of one of the main supply feeders.

6.9.2 Storm Water Drainage System

Instead of direct discharging to sea as per the existing system, an oil /sediment in-line unit is recommended to provide basic treatment to the storm water before discharging to the sea.



A gravity drainage system with additional new outfalls would be required for F-7, the Break-Bulk & Bulk Terminal, and the extended container yard.

6.9.3 Sanitary Sewer System

Direct gravity fall of the sewer from the new extended area at the east part of the Port to the existing central lift station (pump house) is considered too far away as the burial depth of the underground sewer pipes is too deep to maintain the minimum fall along the pipe route. An additional new pump station, located at the eastern part of the Port to pump the sewer to the gravity line in Marine Drive, would be required. Depending on further negotiation to be carried out with GWA, the new pump station would either be built by PAG or GWA.

6.9.4 Domestic Water System

The existing 16-inch main water supply pipe from GWA is sufficient to provide water supply to the extended Port. However, improvement works on the existing underground pipes as detailed below would be recommended. According to the Guam Fire Department the water pressure is marginally low.

A large portion of the water supply pipe serving Shell is routed inside the Port (some of them are under the container stacking areas). Any maintenance works for the pipe would need to be carried out within the Port areas and may interrupt the Port operation. In order to avoid unnecessary interruption to the Port operation, relocation of the pipe outside the Port area should be considered.

Currently the Port experiences water outages from GWA 3 to 4 times every year. As the fire and portable water supplies are mixed and directly fed from the water supply line without any storage tank or pump, a water outage from GWA would also mean an outage of domestic water and fire water. In order to increase the supply security, a new water storage tank should be considered.

Many of the existing gate valves for the underground water pipes are not in good condition. Only a small portion of the valves have been replaced so far from the first installation of the underground water pipe system which dates back several decades ago. Water leakage in one section of the pipe would require the shutting off of more than one valve to stop the leakage. Re-arrangement of the valves should be considered to provide zoning of the water supply to ease future maintenance work.

Some of the underground water pipes are still using asbestos which is a concern for the quality of the water supply and a potential hazard to health. A detailed survey is recommended to be carried out to locate those pipes and arrange replacement.

6.9.5 Yard Lighting

High mast lighting (or light tower) is considered better than the pole mounted light fittings in the existing configuration. This would allow much more flexibility (coverage per high mast or light tower can be much wider) on laying out the lights to suit the efficient operation of the yard and would also be easier to maintain (by both reducing the locations and ease of access to the light fittings).

An initial estimate has been carried out with the illumination level criteria of 50 Lux average for container yard areas. With the use of 50m high mast (with six 2000kW lamps per high mast), the distance between masts can be 300 feet and can fit in with the pattern of the container stacking areas.

NOTE: The Port requested comment on the use of High Mast Lighting in Typhoon prevalent zones. We consider this to be a detailed design issue that should be considered carefully but offer the following comment.

The container terminals that we know of in Taiwan, Hong Kong and mainland china are using light towers. Most of the operators would like to minimize the number of obstructions to their yard resulting in the need to install a large amount of high power light fittings at each lighting location. Hence, it is very difficult to design the light mast to hold the required numbers of light fittings. Thus a balance design approach is necessary consistent with codes, operational efficiency and costs. Another more robust



alternative is light tower. Structural engineer can always design a light tower to cater for certain wind speed requirements. That's also why we have used the term "high mast or light tower" on section 6.9.5

6.9.6 Fire Protection System

As mentioned in Section 6.8.4, the fire hydrants and sprinklers are directly tapped off from the main water supply pipe network (mixed with the domestic water supply system) within the Port. A water outage from GWA would also mean an outage of the fire water supply. In order to increase the fire water supply security, water storage tanks with booster pumps should be considered.

A reliable alternative with lower installation & running cost and no fire water supply security issues is a seawater fire hydrant system for the berths and container yard. A seawater hydrant system consists of diesel-engine-driven fire pumps, cement-lined cast iron pipes, shore fire hydrant and seawater inlet facilities.

Hoses not currently in place adjacent to the fire hydrants should be provided. It is recommended to install the hose cabinets next to the fire hydrants to house the hoses.

6.9.7 Other Building Services

Site lightning protection is recommended to protect both the operating personnel and valuable equipment. Air terminals, down conductors and ground pits should be installed on the high mast lighting and buildings.

6.10 Tenants & Lease Agreements

6.10.1 Current Lease Agreements

We offer the following recommendations with respect to implementation of the Master Plan update as relates to lease agreements summarized in Table 3.2-1.

- PAG should work closely with existing tenants to mitigate the impacts of relocation in order to accommodate future redevelopment.
- Location of tenant pipelines and utilities must be considered in any redevelopment plan.
- PAG should review existing leases without escalation clauses to ensure that the rent reflects current market rates.
- Zoning and land use designations suggested in the current master plan need to be updated to reflect future cargo handling requirements.
- The agreement with the developers of Hotel Wharf needs review and either enforcement or renegotiation.

6.10.2 Recycling Enterprise Zone

Public Lay 28-92 is an act dealing with the creation of a Recycling Enterprise Zone at the Jose D. Leon Guerrero Commercial Port. Our assessment showed that the most suitable location within port property for this facility would be Cabras Island Industrial Park. This would be consistent with the Land Use recommendations in this report.

6.10.3 Cabras Island Industrial Park

The Cabras Island Industrial Park was designated under the previous master plan adopted in 2000. As shown in the Land Use recommendation map in Figures 6.5-1 and 6.5-2 there is no change to this designation. Development of the Industrial Park should proceed consistent with this zoning in support of industrial tenants and for port related industrial support activities and services provided by potential tenants.



6.10.4 Lease Agreements to Encourage Facility Investments

In order to encourage development by the private sector it is recommended that when a tenant makes significant investments in facilities and equipment the Port has the authority to negotiate leases extending up to 20 years in duration in order to provide the tenant with sufficient time for depreciation and amortization of its investment in facilities and equipment.

Development such as those discussed in Section 6.5 adjacent to deep navigable waters for the movement of future types of cargo and waterborne transportation, can especially benefit by providing this flexibility.

6.11 Implementing Near Term Needs

The prime near term driver for modernization of the Port's commercial cargo terminal facilities is the imminent relocation of the military base to Guam. According to DOD's Latest Port Readiness Requirement we understand the latest construction commencement target is July 2010. The extent of the modernization requirements identified in this report and the timeframe available to effect improvements constitute a challenge.

We therefore recommend immediate commencement of various Program Elements that are needed to meet the constrained timeframe. While development of a detailed implementation plan is not part of the master plan scope of work, we offer the following outline of key tasks and activities that should be initiated forthwith in order to begin the modernization program:

- Perform a Financial Feasibility Analyses and Identification of potential Funding & Financing Options.
- Develop detailed alternative Implementation Plans consistent with the findings of the Financial Feasibility results.
- Begin the Site Characterization Work required for engineering and environmental design development.
- Initiate Environmental Analysis and the necessary Federal and/or Local Permitting Process related to typical port development.
- Perform Facility Design Sufficient for supporting the above activities.
- Consistent with Government and Port policy begin a concurrent process to identify potential private and public investment and funding partners.
- We anticipate that the award of a typical form of accelerated delivery method will be required in order to target the anticipated base construction schedule. The findings from the above tasks should be used as the basis for identifying the most appropriate alternative consistent with financial and schedule goals.
- Prepare documents and procure the various forms of contracts necessary to implement the modernization program and begin operations at the new modernized Port of Guam.

We estimate that the schedule for completion of port modernization in time for commencement of base construction is very challenging. Consolidation of appropriate activities may optimize the time frame. A program to initiate the above activities should be planned and put in place forthwith.



Appendix 1-1 Master Plan Update Scope

This Appendix describes the Consultant's Scope of Work for performing this master plan update.

**SCOPE OF SERVICES
FOR THE
JOSE D. LEON GUERRERO COMMERCIAL PORT/
PORT AUTHORITY OF GUAM**

SCOPE OF SERVICES: Update the Port Authority of Guam's Master Plan to include an Impact Assessment on the Port Authority of Guam Facilities due to relocation of Okinawa-based Military Personnel and related ancillary activities to Guam and other anticipated major developments.

Introduction:

The enabling act of the Jose D. Leon Guerrero Commercial Port/ Port Authority of Guam calls for the Port to provide for the needs of ocean commerce, shipping, recreational and commercial boating and navigation of the territory of Guam. PL-27-60 also known as the *Port Public-Private Partnership Authorization Act of 2003* authorizes the Commercial Port Board of Directors to enter into a Public-Private Partnership (PPP) Contract for terminal operations and maintenance and lease of the land known as the Commercial Port area, as well as existing buildings, and operational machinery, vehicles, tools and equipment with the permit to operate the same as a common use port.

Facilities at the Commercial Port

What is now the Commercial Port is a series of wharves and facilities that were started in 1964 and completed in 1969. Primary facilities include the following:

- Berths F-1 – Management and Use Agreement Shell Oil / Hanson Permanente
- F-2 long term lease to Casamar
- F-3 normally accommodates fishing vessels / Vessel Bunkering
- F-4, F-5 and F-6 Main Cargo Piers

- The Port Administration Building
- Container Freight Station- Carrier's Maintenance and Repair Building
- Transit Sheds 1 (Tuna Operations) and 2 (Tuna and Breakbulk Operations)
- Container Yard
- Equipment Maintenance Facility
- Oil Tank Farm – Use and Management Agreement(Mobil Oil)

The Port Authority of Guam is the only civilian commercial cargo handling on Guam and as a result also functions as multi-purpose port. It accommodates containerized, breakbulk, RO-RO, fisheries operations, fuel oil storage and distribution facilities and passenger terminal activities. The current Port Master Plan was last contracted to GMP and Associates, subsequently amended in February 1999 and passed into law in 2000.

Since that report was issued, key assumptions that were made with respect to the Government of Guam's acquisition of military property in the inner portion of Apra Harbor for Port development are no longer valid. For example, the U.S. military had determined that certain BRAC 95 properties such as the Drydock Island would be retained for future use.

Other areas under the Commercial Port umbrella include the Golf and Hotel Piers, Family Beach, Port Beach, Aqua World Marina, Piti Channel/Harbor of Refuge, Gregorio D. Perez Marina in Hagatna and the Agat Marina.

Other developments have occurred that have impacted the long term strategic plan of the Port Authority. One such development is the signing of a long term lease for the development of fisheries facilities between the Port Authority and the Guam YTK Corporation. Another is the approval of a grant from the Economic Development Agency for the architectural and engineering services for a deep draft wharf in Apra Harbor. Still another is the development and

implementation of the Facility Security Plan for the Port Authority of Guam. This plan was a requirement of all marine terminal operators as mandated by the Maritime Transportation Security Act of 2002.

The home-porting of nuclear submarines at Polaris Point is a positive indication of the efforts to boost the military's presence on Guam as well as the recent announcement of the relocation of over 8,000 Marine troops and their dependants to Guam.

The Port Authority of Guam is issuing this request for proposal to obtain the services of a qualified CONSULTANT or firm to determine the impact of the proposed military relocation and other anticipated major developments on the Port's infrastructure and to utilize the information compiled to update the Port Master Plan.

SCOPE OF SERVICES

- 1.) The CONSULTANT will conduct on-site interviews with Port management and staff to obtain input for consideration in the update of the Port Master Plan.
- 2.) The CONSULTANT will conduct interviews with Port user groups such as the Guam Chamber of Commerce and other private sector community members such as the logistics sector, fisheries sector, tourism related sectors and others to determine their future needs for consideration or inclusion in the Port Master Plan.
- 3.) The CONSULTANT will conduct interviews with pertinent government agencies such as Guam Economic Development and Commerce Authority (GEDCA), Bureau of Statistics and Plans (BOSAP), Guam Visitor's Bureau, Department of Public Works, Guam Waterworks Authority, Guam Power Authority, Mayor's Council of

Guam, A.B. Won Pat International Airport Authority, Committee on Tourism, Maritime, Military, Veterans and Foreign Affairs, the Office of the Washington Delegate and other government agency stakeholders for input to the Port Master Plan. All pertinent and relevant data and statistics will be made available and included in the Port Master Plan.

- 4.) The CONSULTANT will conduct interviews with the local DOD representatives of the Guam Surface Deployment and Distribution Command responsible for moving military cargo and/or other DOD components, US Coast Guard and federal agencies to assess their needs with respect to the Port's cargo handling capability.
- 5.) The CONSULTANT will provide demand traffic forecasts for five (5), ten (10), fifteen (15) and twenty (20) year projected container and break-bulk cargo volumes.
- 6.) The CONSULTANT will examine the Port Authority of Guam's present infrastructure and provide projections for five (5), ten (10), fifteen (15) and twenty (20) year future infrastructure requirements in the areas of oil storage, water, sewer, electrical, communications systems, wharf waterfront expansion, warehousing and/or container yard expansion to accommodate realistic and expected future expansion. Provide an assessment of existing facilities and present alternatives for the highest and best use of the Port facilities. Provide construction cost estimates for infrastructure improvements.
- 7.) The CONSULTANT will review all existing agreements and other binding documents and identify those that may pose as an impediment or may be beneficial to planned Port development.

- 8.) The CONSULTANT will utilize available data to determine facility utilization rates for the different types of cargo operations and passenger terminal operations. The CONSULTANT will conduct interviews with Port users and obtain input in the update of the master plan.
- 9.) The CONSULTANT will conduct an assessment of the capability of the PAG equipment inventory to handle existing cargo volumes due to local consumption, tourism, transshipment and military presence. The CONSULTANT will assess the Port's capability based on the projected increase of cargo due to the planned military buildup, maximum surge volume capacity and the increased baseline of local consumption cargo. Provide recommendations as to optimum equipment inventory and optimum use of equipment.
- 10.) The CONSULTANT in consultation with the US Coast Guard will address adequacy of navigational aids for the harbor and marina waters under the Port's jurisdiction.
- 11.) The CONSULTANT will identify and list all local and federal requirements for recommended Port projects, such as environmental assessments, environmental impact statements or other types of compliance requirements.
- 12.) The CONSULTANT will conduct interviews with marina users and stakeholders. The CONSULTANT will review operations at both Port-operated marinas and present alternatives as to management regimes, make recommendations to reduce overall expenses and/or recommend improvements in operations, recommendations in the marina rates charged to users to provide funding for necessary capital improvements. Increases in rates or fees charged may necessitate an economic impact study.

- 13.) The CONSULTANT will review current Port security procedures and practices and to provide additional recommendations as or if necessary. The proposed recommendations must be in compliance with the edicts of the Maritime Transportation Security Act of 2002 and other pertinent local and federal regulations such as Guam Customs and Quarantine, etc.
- 14.) The CONSULTANT with consultation from the Department of Parks and Recreation Guam Historic Preservation Officer will conduct a site survey of Port properties to identify and inventory historic sites.
- 15.) The CONSULTANT will provide monthly progress reports summarizing the work performed during the preceding month and significant findings. The CONSULTANT will submit copies of the interviews conducted in support of the Port Master Plan as well as provide the formulas used and the methodology followed to obtain the results reported. The monthly reports will be submitted in both electronic media (CD) and at least 8 hard copies.

Additional Information

The CONSULTANT is aware that public hearings must be held and that the Master Plan Update must be approved by either the Application Review Committee or other such agency body, and in addition the Governor and the Guam Legislature.

The Port Authority of Guam intends to hold two Port Development Conferences, one in Spring of 2007 and the other in Fall 2007, the Consultant will be required to attend each conference. During the public hearing phase and other such meetings such as the Board of Directors' meetings the CONSULTANT will be required to be present to answer questions regarding the Master Plan Update.

Appendix 1-2 Meeting Notes

List of Meetings

	Company, Organization or Individual	Meeting Date
1	Ambyth Shipping & Trading Co., Inc.	08/10/07
2	Casamar Guam, Inc.	08/10/07
3	Marianas Steamship Agencies, Inc.	08/08/07
4	PAG Operations Staff	08/08/07
5	Military Surface Deployment and Distribution Command (SDDC)	08/10/07
6	Bureau of Statistics and Plans & Coastal Zone Management	08/08/07
7	Department of Labor	08/08/07
8	Guam Economic Development and Commerce Authority (GEDCA)	08/07/07
9	Horizon Lines	08/08/07
10	Matson Navigation Company	08/08/07
11	PAG Finance Department	08/10/07
12	Seabridge, Inc. & Cabras Marine	08/08/07
13	Director of Department of Public Works (DPW)	08/09/07
14	Guam Power Authority & Guam Water Authority	08/09/07
15	PAG Maintenance Department	08/10/07
16	Parks & Recreation Department / Historical Preservation Division	08/31/07
17	Oceaneer Enterprises, Inc.	08/10/07
18	Marianas Express Lines / CTSI Logistics	08/08/07
19	Port of Guam Commercial Facilities Field Tour	08/07/07
20	Shell Oil	08/09/07
21	Maritime Affairs Committee	08/09/07
22	U.S. Coast Guard	08/27/07
23	Marina Fishing Boat Users	08/29/07
24	U.S. Coast Guard	08/27/07
25	PAG Security	08/27/07
26	Watts Constructors	09/09/07
27	Guam Visitors Bureau	09/12/07
28	Guam Power Authority	09/09/07
29	Black Construction	09/12/07
30	PAG Operations	09/12/07
31	PAG Equipment Maintenance Staff	09/12/07
32	PAG Lease Review	09/12/07
33	Horizon Lines	09/14/07
34	Fishermen's Cooperative & Long-liner Tenants	09/12/07
35	Harbormaster	09/12/07
36	Two Day Port Development Conference	9/13-14/2007
37	Guam Development ICA Meetings, Washington D.C.	11/19/07
38	FRC Meetings, San Francisco, CA	12/12/07



Port Authority of Guam Master Plan Update

Meeting: Ambyth Shipping & Trading Co., Inc.

Attendees: Andrew Miller, Group General Manager, Ambyth Shipping
Nira Ratnathicam, PB
Paul Sorensen, PB Team Member
Bob Hrdlicka, PB Team Member

Place: Port Authority of Guam Conference Room

Date: August 10, 2007

Discussion Notes:

- Ambyth is a steamship agent for Maersk, Swire Shipping and Seabridge. They also do trucking of container, break-bulk cargo and bulk oil products. In addition, they also do warehousing and distribution, operate an off dock CFS; arrange air freight; do ship husbanding for MARAD vessels as well as ship repair in Saipan.
- They handle approximately 20 – 30 containers monthly including 2 x 20 foot containers for Shoemart for which they do distribution.
- Mr. Miller offered a tour of their distribution facility in Harmon.

PAG Operations Issues:

- PAG staff has the knowledge and ability, but Ambyth is hopeful that the new leadership at PAG is less political. Ambyth feels that there needs to be a more commercial mindset. They feel that there are too many “easy out” clauses in the PAG tariff for lack of availability of manpower and equipment.
- Equipment maintenance and availability is a major issue. On their feeder vessel, they need a port crane.
- Ambyth feels that PAG needs more staff at the terminal operating level.
- Ambyth would like to see night deliveries and a continuous operation during the day with no lunch breaks.
- The dwell time on their inbound containers is about 2 days.



Port Authority of Guam Master Plan Update

Meeting: Casamar Guam, Inc.

Attendees: Kwang (Kay) Kim, General Manager, Casamar Guam
Luis Serrano, Asst. General Manager, Casamar Guam
Nira Ratnathicam, PB
Paul Sorensen, PB Team Member
Bob Hrdlicka, PB Team Member

Place: Port Authority of Guam Conference Room

Date: August 10, 2007

Discussion Notes:

- Casamar is located at Berth F-2.
- They do ship repair on 250 to 270 fishing boats. In addition, they also repair fishing nets.
- Most of their customers are Korean.
- They have a 250 ton capacity crane at the facility for lifting boats from the water for dry docking.
- Their facility may need dredging. Water depth is currently 24 to 26 feet. They would like to have 30 feet of depth.
- Tuna prices have been steady to falling over the last few years, but costs keep going up which makes it difficult for the fishing fleet.
- It is getting increasingly difficult for fishing boats to come into Guam due to increased US Coast Guard security requirements.
- Casamar's original lease was with GEDCA, but the lease is now administered by the port authority. They have over 40 years remaining on the lease and have no intention of moving as was called for in the last master plan.
- Their facility is located on a "corner", and because of this, when the wind is wrong oil and debris float into their facility. The Coast Guard fines them for this even though they did not cause the problem. They also get waste water from the fishing dock at berth F-3 which causes an odor.



Port Authority of Guam Master Plan Update

Meeting: Marianas Steamship Agencies, Inc.

Attendees: Byron Valera, Operations Supervisor, Marianas Steamship Agencies
Nira Ratnathicam, PB
Paul Sorensen, PB Team
Bob Hrdlicka, PB Team

Place: Port Authority of Guam Conference Room

Date: August 8, 2007

Discussion Notes:

Marianas Shipping Agencies is the agent for Kyowa Steamship Co. Kyowa operates a feeder service that connects with NYK and MOL out of Asia.

The vessels call every two weeks. Inbound volume from Asia to Guam averages 50 TEU to 60 TEU per voyage, 10% of which is transhipped to Micronesia. Outbound volume to Asia averages 16 TEU to 24 TEU per voyage. Volume has dropped over the last 5 years. Their main competitor is Matson.

Issues of Concern with Guam:

- Main concerns are availability of manpower and equipment, primarily chassis.
- Only Matson and Horizon have chassis. Port generally gets by with what they have, but needs to acquire bomb carts.
- Marianas Shipping Agencies would like to see more berthing space. Suggest that fishing vessels should be moved.
- Harbormaster schedules berthing, so suggested that PB team talk to the harbormaster for berthing information.
- All Marianas' vessels have their own gear, so cranes are not an urgent concern to them.
- Marianas uses Warehouse #2 for loose cargo. They encounter problems when delivering cargo since consignees have to go through security in order to enter the secured area of the terminal. They suggested that it would be better for them if the warehouse were located closer to the gate with access that would not have to go through security. They cited the delivery of autos as an example.



Port Authority of Guam Master Plan Update

Meeting: Interview with PAG Operations Staff

Attendees: John Santos, Operations Manager
Joe Ulloa, PAG Operations Staff
John Borja, PAG Operations Staff
Nira Ratnathicam, PB
Paul Sorensen, PB Team Member
Bob Hrdlicka, PB Team Member

Place: Port conference room

Date: August 8, 2007

Discussion Notes:

- PAG operations staff is currently doing a trucker survey regarding traffic congestion which will show commercial truck and chassis needs. It will help in determining whether to go grounded or wheeled in the container yard.
- Current RTG's are 1 over 4, 5 containers plus truck lane wide.
- They use a graphic tracking system from a Philippine company to track containers in the yard. There is a tie-in with computers for Horizon and Matson only. Marianas Steamship Agencies doesn't use the tie in.
- 80% of the containers in the yard are wheeled and 20% are grounded.
- Most of the grounded containers are empties and handled with a side pick lift truck.
- Foreign containers are handled with the RTG's.
- Ship gang manning (one crane operation) is as follows: Ship side: 2 crane operators, 5 truck drivers, 1 side pick driver, 1 RTG operator, 1 crane leader, 1 equipment leader and 6 lashers. On the terminal side: 1 planner, 1 dockside clerk, 1 van control, 1 yard man, 1 supervisor, 1 reliever.
- They work 2 shifts of 12 hours each against the ship.
- Normally have 5 people at the gate. Starting wage for a checker is \$8.48 per hour.
- Vessel agent does the stow plan, except on foreign ships where the captain does the stow plan for the containers loaded.



Port Authority of Guam Master Plan Update

Meeting: Military Surface Deployment and Distribution Command (SDDC)

Present: Gordon Lowe, Director, SDDC
Pete Lujan, SDDC
Lt. Cdr. Dean Hansen, NAVFAC
Paul Sorenson
Nira Ratnathicam
Bob Hrdlicka

Place: Port conference room

Date: August 10, 2007

Discussion Notes:

Military Surface Deployment and Distribution Command (SDDC) manages surface cargo movements and logistics planning, does port and highway engineering and roadwork, and operates military cargo ports, e.g. Naha, Busan and Yokohama.

Naval Facilities Command (NAVFAC) does military contracting.

- The Guam inner harbor is controlled by the Navy.
- For military support only and only handle Navy ships (no Navy ships "home ported out of Guam).
- The Navy has their own harbormaster.
- There is no commercial cargo handled in the inner harbor.
- The planning for the shift from Okinawa is currently in the NEPA process and expect that this process will be done by 2010.
- It is expected that the shift will be done by 2014 based on the treaty with Japan.
- If there is any delay on the front end of the preparations for the shift, it will cause a higher spike in cargo traffic since the back end of the shift is fixed by treaty.
- SDDC anticipates a peak volume of 62,000 TEU in 2015 of inbound cargo. Outbound empty containers will double that volume. This cargo includes break-bulk cargo calculated at 23 measurement tons per TEU.
- From 2018 onward, expect 26,000 TEU of growth over present base volume in support of the new personnel.
- The cargo volume estimates do not include any commercial cargo (i.e. non-military) for support personnel, construction workers, etc. (e.g. food & clothing purchased from K Mart).



- The cargo shifted from Okinawa will be on the basis of "Cargo Preference" meaning that U.S. flag ships will be required if available.
- The U.S./Japan treaty is not yet clear as to who pays for shipping.
- Even construction material will be under "cargo preference" rules.
- For family housing they are leaning toward using pre-cast concrete panels that would be fabricated off shore and shipped in.
- Anticipate 3520 homes, no high rises.
- Watts Construction would be a good data source.
- Cost for shifting the Marines is anticipated to be USD \$10.3 billion, not including furnishings for family housing homes, off-base housing, off-base infrastructure and any expenses connected with Army, Navy or Air Force personnel. The other service branches will add an anticipated 20% to the cost.
- Lt. Col. Pete Ridilla (Air Force) would be a source of information for costs connected to Anderson AFB.
- The EIS is into the scoping phase with a draft report anticipated in July, '08 with a record of decision in January of 2010. There will likely be law suits.
- We will likely need to plan for an off terminal staging area – contractors are usually responsible for setting this up.
- Dwell time for inbound military cargo is usually 2 to 3 days. In order to keep dwell time down it will be necessary for PAG to set demurrage rates high enough to be a true penalty.
- SDDC concerned that PAG will not build enough facilities to handle the surge due to the fear of what will happen to volumes after the surge.
- The pilots would be a good source of information about dredging needs.



Port Authority of Guam Master Plan Update

Meeting: Bureau of Statistics & Plans

Present: Tony Lamorena, Director, Bureau of Statistics and Plans
Evangeline (Vangie) Lujan, Administrator Guam Coastal Management Program
Frank Dayton, USACE
Nira Ratnathicam, PB
Paul Sorensen, PB Team
Bob Hrdlicka, PB Team

Place: BSP offices

Date: August 8, 2007

Discussion Notes:

Consultants opened the meeting with a brief discussion of the master plan update and the purpose of the meeting; and solicited input from BSP.

Tony had just returned from a trip to Washington DC with Ken (Port Manager). They met with several agencies (USDA, HUD, Environmental agencies et al).

Tony provided us with an EIR for Kilo wharf (Nira has this). He suggested we also get the Powerpoint presentation for the EIR.

Vangie stressed that recreational opportunities around the Port should be stressed because they are very important to the community. The area needs a balance between local and tourist quality of life and DOD buildup. Tourism is a year round activity.

Regarding economic statistics, Vangie and Tony suggested the following:

- Bureau of Statistics Annual Year Book (we obtained 2005 report, latest available)
- Convention & Visitors Bureau
- Guam Economic Development Plan
- KMPG has just been hired to assess economic development needs
 - "The contract with consulting firm KPMG to produce an investment-grade strategic plan and guide local decisions in preparation for the military buildup was signed today in Washington, D.C. Guam Economic Development and Commerce Authority Administrator Tony Blaz signed the contract with KPMG representative Chris Melling, beginning a professional relationship that will improve the quality of life for Guam's residents as Marine forces realign here. "The signing of this contract is an important step as we prepare for unprecedented military growth," Governor Felix P. Camacho said. "We are working quickly with a growing partnership of people committed to ensuring that the growth over the next decade benefits our people." The \$499,591 contract, which is entirely funded by the Office of Economic Adjustment under the leadership of OEA Regional Director Anthony Gallegos, initially will involve the creation of a management organization to coordinate and oversee GovGuam actions in support of military build-up. KPMG also will develop an initial characterization of challenges facing the island with follow-on actions and establish a public information program. The initial work under the contract will be completed by November 2007, coinciding with the military's expedited timeline. Follow-on grants from OEA are expected to provide more of the resources



required to allow Guam to complete its preparation. KPMG was selected through the competitive procurement process from a slate of 12 highly qualified companies that responded to GEDCA's request for proposals."

Vangie/Frank discussed GIS and CZM issues.

The issues for development in the harbor normally include Coral, Fish, Sea Grass and the eco system. Baseline of what exists is used to identify impacts and mitigation requirements.

There is a huge coral bed offshore from the proposed Berth F-7 location. There had been previous discussions with others who indicated that the coral was not alive. Tests have been done to determine if the coral is alive. The Master Plan team should follow-up on available information.

Frank Dayton recommended that PB contact James Hatashima, USACE in Honolulu for more information on what is likely to be needed for getting approvals on a port expansion. Another name for contact was Milton Yoshimoto also out of USACE, Honolulu. There is a development guide available for issues such as Storm water treatment. Any development in the harbor will require Federal consistency.

The coastal management team also has an extensive GIS database that it has created including LIDAR information on the underwater bathymetry in the harbor. It made arrangement to have this information made available to the team.



Port Authority of Guam Master Plan Update

Meeting: Department of Labor

Present: Gary Hiles, Chief Economist, Department of Labor
Paul Sorensen, PB Team
Vincent Munoz, PB Team

Place: DOL offices

Date: August 8, 2007

Discussion Notes:

Consultants opened the meeting with a brief discussion of the master plan update and the purpose of the meeting; and solicited input from DOL.

Gary suggested several data sources:

- Gary has an extensive trend series of employment by industry (he will provide).
- Bank of Hawaii and First Bank of Hawaii Economic Outlooks.
- Guam Power Authority had Dr. Peter Mayer and Clem Farney do a study about a year ago.
- Guam Customs has manifest documents which Gary used to summarize important imports and exports. This is now done by another agency.
- Income stats from US Bureau of Census.
- Economic Census from Bureau of Census.
- Convention & Visitors Bureau – They recently did a study of economic impacts of tourism, but Gary believes this is overly conservative. Study done by Global Insight (we have a copy).
- In addition to DOD and tourism, there is manufacturing for local market consisting of food processing, printing and ship repair. There are also exports of fish (a large portion of which goes by air).
- Presentation to S&P in May 2007 (we have).
- Revenue and Tax – Monthly revenue statement of taxes by industry.
- Governor's Budget has useful data on economy.



Port Authority of Guam Master Plan Update

Meeting: Guam Economic Development and Commerce Authority (GEDCA)

Present: Sheila Suguitan, Industry Development Specialist, GEDCA
Greg Sablan, Industry Development Specialist, GEDCA
Nira Ratnathicam, PB
Paul Sorensen, PB Team
Bob Hrdlicka, PB Team

Place: GEDCA Office

Date: August 7, 2007

Discussion Notes:

Consultants opened the meeting with a brief discussion of the master plan update and the purpose of the meeting; and solicited input from GEDCA.

GEDCA is a public corporation (12GCA Chapter 50) with broad responsibility for the centralized direction, control and supervision of an integrated plan for the economic development of Guam. GEDCA's mission is to develop a sound and sustainable economy through innovative programs that preserve and promote local culture, economic opportunities and quality of life. Greg noted that GEDCA's main job is to attract investors to Guam. Their website is investguam.com.

Greg and Sheila discussed the potential for distribution centers in Guam. A representative of Nike's (Mike McBreen) indicated that there may be an opportunity to consolidate cargo from Asia to the mainland US through Guam. A study was undertaken to evaluate this option and found that sea/air was viable (i.e., sea-air cargo by water from Asia with clearance at Guam and air shipment to mainland US). This is a priority of GEDCA's and is supported by Horizon and Matson.

GEDCA has a real property division (RPD), which is responsible for the development and management of GEDCA's industrial park program. The properties consist of 26 individual property leases on 177 acres of developed lands in order to generate new jobs, revenue and increase economic opportunities. According to GEDCA's website, the program has generated average annual employment of 1,000 jobs, average annual payroll of over \$20 million, average annual gross sales of \$70 million, and annual gross receipts tax of \$2 million. The property includes some land around the port. Contacts for RPD are Mike Cruz and Larry Tovus.

GEDCA is active with the Industry Fair which was held Aug 23 and 24, 2007.

Regarding data for economic development, Greg suggested the following sources:

- Investguam.com
- Bureau of Statistics and Plans
- Bureau of Budget and Management
- Department of Labor (Maria Connelly)
- Guam Customs (Acting Director, Col. Rafaelle Sgambelluri)
- Airport (Rolinda Bojan, marketing).

Port Authority of Guam Master Plan Update

Meeting: Horizon Lines

Present: Rick Agustin, Operations Manager, Horizon Lines
 Nira Ratnathicam, PB
 Paul Sorensen, PB Team
 Bob Hrdlicka, PB Team

Place: Port Authority of Guam Conference room

Date: August 8, 2007

Discussion Notes:

Consultants opened the meeting with a brief discussion of the master plan update and the purpose of the meeting; and solicited input from Horizon Lines.

Rick has had an extensive career in shipping in the islands, beginning with SeaLand through CSX and to Horizon Lines.

Horizon Lines operates a weekly service with five ships between Tacoma, Oakland, Hawaii, Guam, Asia (Yantian, Hong Kong and Kaohsiung). Voyage takes 35 days. Feeder service is provided to the Commonwealth of the Northern Marianas.

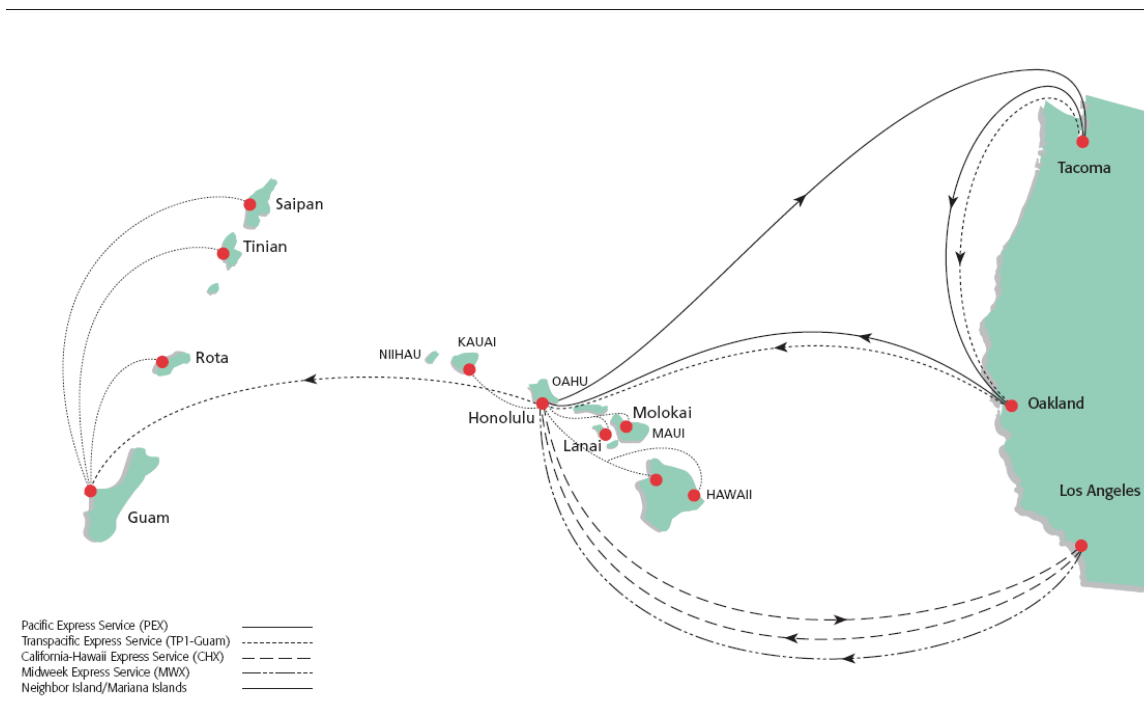

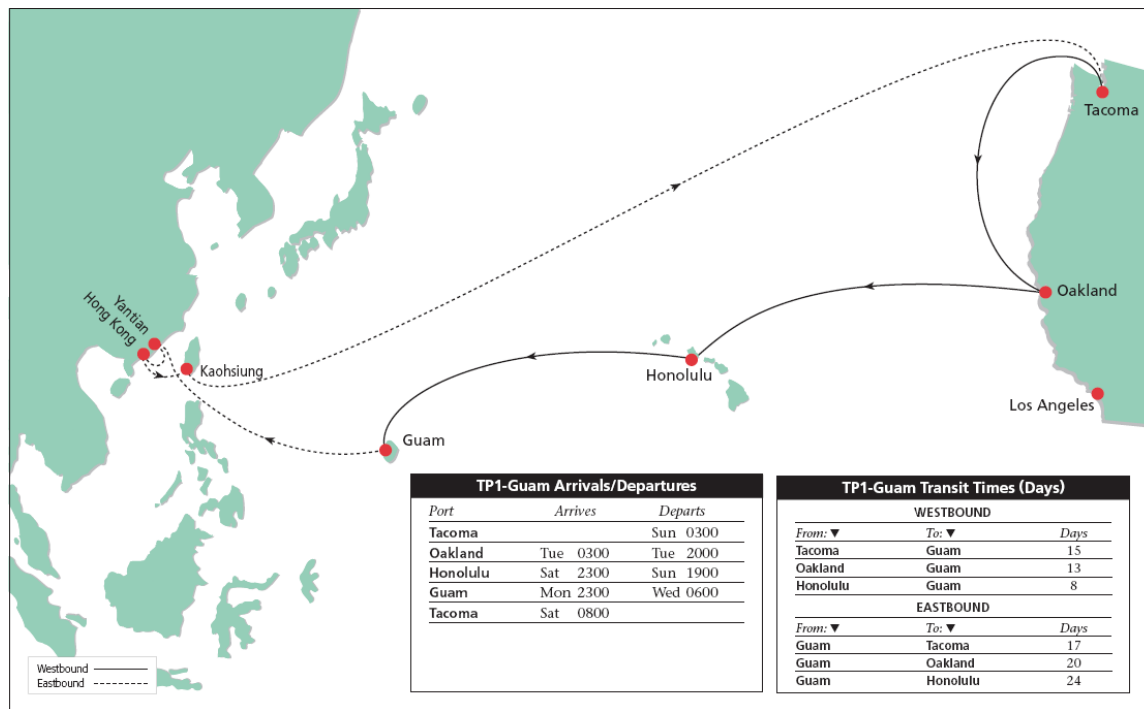

The Horizon Lines ships are new, with service to Guam by five Hunter class vessels, all with a carrying capacity of 2,824 TEUs and service speed of over 23 knots. They are U.S.-flag, foreign built vessels that Horizon Lines is chartering from subsidiaries of Ship Finance International Limited under definitive long-term charters and related agreements. The ships are:

- Horizon Hawk
- Horizon Hunter
- Horizon Falcon
- Horizon Tiger
- Horizon Eagle

Rick gave Nira specs on these ships.

The Guam service has approximately 250 lifts per call. Approximately 70% are 40s, 20% are 20s and 10% are 45s. The mix is changing somewhat over time.

Volume is growing due to new big box retailers (Home Depot) and DOD buildup. Approximately 50 of the 250 lifts at the present time are DOD but this is expected to grow as the military's presence increases. The Horizon Spirit has serviced the Red Horse squadron buildup, with service from Incheon to Guam. There is also new DOD activity in CNKI, particularly at Tinian. Horizon works with Seabridge to serve Saipan and the CNMI. Horizon also serves Micronesia with Kyowa.

Issues at the Port of Guam include the following:

- There isn't enough labor to service all vessels during peak periods
- Equipment is deficient (gantry crane doesn't work, takes up room)
 - Average productivity is 19 lifts per hour with existing equipment but should be 28 lifts per hour.



- Delays in Guam affect the whole schedule
- Horizon brought chassis to Guam to better service the customers
- Warehouse 2 needs to be demolished to create more chassis space



Port Authority of Guam Master Plan Update

Meeting: Matson Navigation Company

Present: Vic Angoco, General Manager, Horizon Lines
Nira Ratnathicam, PB
Paul Sorensen, PB Team
Bob Hrdlicka, PB Team

Place: Port Authority of Guam Conference room

Date: August 8, 2007

Discussion Notes:

Consultants opened the meeting with a brief discussion of the master plan update and the purpose of the meeting; and solicited input from Matson.

Vic has been with Matson since Dec 2006 but worked with Young Bros in Hawaii. He used a top-pick system there which worked well. He is encouraging the Port to get 6 new top-picks. Matson brought a top-pick to Guam to use when needed. Matson has 30 employees in Guam and around 200+ in Hawaii.

Current productivity with the cranes is 16-19 moves gross (1st to last with no deduction for breaks). He would like to see 22+ moves per hour.

Matson had a relationship with APL for service to Guam. But according to the company's website:

"2006 is a transition year for Matson and its Guam service. After serving Guam and Micronesia for 10 years as part of a Matson/APL alliance agreement, the company is launching a new Matson-dedicated service. Guam will now be served weekly by Matson's five most modern, fuel-efficient vessels, four of which have been built in the past four years. In addition, Guam operations on the West Coast will be supported by Matson-dedicated facilities in Long Beach, Oakland and Seattle. Developing this successor service has been a high priority for Matson and one that represents a long-term commitment in terms of financial investment and service offerings. That commitment extends to all of Guam's neighboring islands. Equally important is the fact that Matson's knowledgeable Guam staff will continue to work closely with the customer community in delivering personalized, high quality customer service".

The Long Beach Express has the following characteristics according to Matson's website:

- Container volume both westbound (Hawaii and Guam) and eastbound (China)
- Competitive transit times in China - Long Beach trade lane: Ningbo to Long Beach in 13 days, Shanghai to Long Beach in 11 days
- Fast, reliable, weekly service provides the best total cost solution
- Newer, fuel efficient vessels
- Dedicated Matson Long Beach facility & fast, efficient gate turn times (avoiding congestion of large multi-user international container terminals)
- Online technology that provides total in-transit cargo visibility
- Subsidiary Matson Integrated Logistics can expedite shipments to virtually any inland U.S. destination



The Matson Lines ships are new with a carrying capacity of 2,500 to 2,800 TEUs. The ships calling at Guam are:

- MAUNALEI
 - CV2500 Class Vessel
 - Length: 681 ft.
 - Max. Speed: 22.1 Knots
 - Max. Deadweight: 33,480 LT
 - TEUs: 2,500
- MANULANI, MAUNAWILI, MANUKAI
 - CV2600 Class Vessels
 - Length: 712 ft.
 - Max. Speed: 22.5 Knots
 - Max. Deadweight: 37,752 LT
 - TEUs: 2,600
- MAHIMAHI
 - C9 Class Vessel
 - Length: 860 ft. 2in.
 - Max. Speed: 23.0 Knots
 - Max. Deadweight: 30,167 LT
 - TEUs: 2,824

In 2005, Matson developed agreements with Kyowa and Marianas Express Lines Limited (MELL) to ensure continued service to Palau, Yap and the FSM as a result of the dissolution of PM&O Lines. Matson now works with MELL but not Kyowa. Kyowa began to work with Horizon Lines. According to Matson's website, the vessels used on this service include:

- STADT HAMBURG
- ISLANDER
- SYLVETTE
- HANEBURG

Port was thinking that they should go 80% grounded and 20% chassis but Vic doesn't think this is the way to go. Chassis help to get the cargo out of the yard faster which is desirable to customers (including DOD).

Issues/challenges at the Port of Guam include the following:



- Lack of equipment or poor maintenance (cranes, top-picks and RTGs)
 - RTGs not used enough and have become maintenance problem
 - Weather conditions make maintenance very difficult (even for company owned equipment (like chassis)
- Need more berth space and upland space
 - Need to tear down warehouse and admin office area
 - Could develop these functions at the nearby Cabras industrial park
- Need to fix the gates – systems don't communicate well because Port has a standalone system.
- Lack of labor (there are no casuals)
- Lack of equipment and labor make it difficult to turn the ship in 24 hours



Port Authority of Guam Master Plan Update

Meeting: PAG Finance Department

Present: Jose "Jojo" B. Guevara, Financial Affairs Controller, Port of Guam
Nira Ratnathicam, PB
Paul Sorensen, PB Team
Bob Hrdlicka, PB Team

Place: Port Authority of Guam Finance Department

Date: August 10, 2007

Discussion Notes:

Consultants opened the meeting with a brief discussion of the master plan update and the purpose of the meeting; and solicited input from Financial Affairs Controller.

Jojo explained the loans underway at the present time to pay for new equipment (2 gantry cranes, 2 top-lifts, 1 RTG):

- USDA loans at 4.5% interest
- Local bank loans at 5.75% (with 90% guarantee by USDA)

Tariff has not changed since 1993. It was reviewed in 2000 (Cornel Group) but recommendations from the study were not implemented. Changes to the tariff have several steps to become enacted:

- Public hearing
- Legislative approval
- Governor's approval

Jojo discussed rates for container operations (\$185/container for chassis, \$255 for grounded) to cover port and labor charges. A different rate is assessed for trans-shipment.



Port Authority of Guam Master Plan Update

Meeting: Seabridge/Cabras Marine

Attendees: Joseph Cruz, President, Seabridge
Paul Blas, General Manager, Seabridge
Nira Ratnathicam, PB
Paul Sorensen, PB Team
Bob Hrdlicka, PB Team

Place: Port Authority of Guam Conference room

Date: August 8, 2007

Discussion Notes

Consultants opened the meeting with a brief discussion of the master plan update and the purpose of the meeting; and solicited input from Seabridge/Cabras Marine.

Seabridge operates as a feeder service for Matson and Horizon with the schedule matched to Matson's and Horizon's on Guam. They have 1 voyage per week to Guam with volumes averaging 150 TEU's per voyage.

Historically, one of the major markets they have served has been Saipan. However, with the decline in the garment industry in Saipan, they have seen a dramatic decline in their liftings to/from Saipan. This is partially due to a shift of the industry to China as well as the US government imposing higher minimum wage requirements on Saipan. They currently handle approximately 50 TEU's per week, but expect that the liftings of outbound garment shipments from Saipan to go to zero sometime next year. They will continue to handle cargo to Saipan, however.

The decline in the Saipan garment industry has had a significant impact on Seabridge revenues and the need for the Port Authority of Guam to become much more efficient in order for Seabridge to control its costs.

Issues at the Guam terminal:

- Vessel production is too low. They currently average only about 11 moves per hour on the vessels. They have a goal of 33-35 moves per hour.
- Main issues that they see are crane and support equipment availability, manpower availability and crane reliability.
- The efficiency of moving freight in and out of the gate is needs to be improved.
- They feel that employees need additional training, especially in maintenance.
- Berthing of the vessels is OK.
- Seabridge would like to see the warehouses removed in order to open up more yard space and working area next to the ships.
- They are concerned also about highway access into the terminal following a typhoon.



Seabridge is interested in a potential for sea/air shipments to/from Micronesia in conjunction with Matson.

Seabridge will be handling cargo to Tinian for a new Marine Corps training facility.

*They suggested that we contact Rubin Domingo of Shell to discuss tanker issues.



Port Authority of Guam Master Plan Update

Meeting: Department of Public Works (DPW)

Attendees: Lawrence P. Perez, Director of Department of Public Works (DPW).
Ibrahim Soudy, PB
Nelson Wu, PB
KP Leung, PB
LC Wang, PB

Place: DPW conference room

Date: August 9, 2007

Discussion Notes:

Questionnaire regarding roads accessing to GUAM Commercial PORT (PORT) is presented to the authorities as listed below:

1. Collect existing road conditions, e.g. road capacity, alignment & profile parameter, etc., and service conditions for road access to PORT, including Route 11 and Route 18 (Causeway Road).
2. Collect road extension or improvement for coming years (in 5, 10, 15, & 20), considering Route 11, Route 18, and intersection with Route 1 (Marine Drive).
3. Collect historical records for road blockage, especially during the typhoon season (flooding).

Below is the summary of what was discussed and exchanged at the meeting.

Information Exchanged

- Minor constructions (regular maintenance) for road are in progress by DPW on an annual basis.
- Protection for road along seashore to prevent flooding from overtopping sea water to road during the typhoon season, is under study by support of Army Corps of Engineers. This will provide feasibility of shifting the Route 11 toward the seashore, and consequently expanding the footprint for Port Master Plan Update.
- Existing Route 11 is 2 traffic lanes (with shoulders), aligned within the Right of Way (ROW) of 100 feet, some bridges (Width is to existing width only) are included. Widening of Route 11 within ROW is feasible.
- As-built drawings for Route 11 & 18 and Route 1 (intersection) are to be provided by DPW after meeting via project communication channel (Mr. Joe John).
- Guam Master Plan 2010 & 2020 indicated that generally the road is in a good condition for both bearing capacity and traffic flow (V/C ratio). DPW is able to provide photocopy for PB as reference via project communication channel. Both plans did not reflect on the military requirement. Guam Master Plan (2030) is being updated by designated consultant (EarthTech), and is foreseen to be available by January 2008.
- Traffic flow will be delayed by 10~20 minutes between peak hour and regular time.
- Traffic Escort can be arranged for particular requirement, such as oversized materials, hazardous materials, etc, during the night time (22:00 to 06:00). Head clearance 15' (4.6 meters) shall be considered for road transportation.



Port Authority of Guam Master Plan Update

Meeting : Guam Power Authority & Guam Water Authority

Attendees: John Benavente, Chief Executive Officer of CCU
Andy Balajadia, Acting GM of Guam Power Authority (GPA)
Nelson Wu, PB
LC Wang, PB
KP Leung, PB

Place: Guam Water Authority (GWA) conference room

Date: August 9, 2007

Discussion Notes:

The attached questionnaire regarding the power supply and water supply was presented and discussed with the authorities. Below is a summary of what was discussed at the meeting.

Power

The power supply to the Port is tapped off from an overhead line along the road outside of the port and this overhead line also feeds other piers and facilities along the road. The line goes underground out from the power station and turns into an overhead line along the road. The line is radial fed and is without ring arrangement.

GPA agreed to provide further details on the present provision to the port and would also provide single line diagram to illustrate the connection arrangement on the distribution side for the feeder feeding the port.

GPA advised that their master plan would be finished by Dec 2008 and they have already got the plan to have generation capacity upgraded from 40MW to 60MW by the time of 2012, 2013 and then further upgraded to 80MW in 10 to 20 years time. A power point extract to illustrate the projection of generating capacity was provided (see attached) for easy reference. GPA indicated that they would pass on to PB the power point presentation to the Navy, which contained an updated version of the projection. GPA indicated that right now diesel would be the most efficient way for electricity generation; however GPA also indicated that they may also consider having a coal-fired power plant. GPA was also considering the possibility of using the unoccupied lands in the port. GPA agreed to provide a rough estimate of the footprint for the power plant in the preparation of the master plan for PB reference.

GPA indicated that the general capacity for 13.8kV feeder would be around 8 to 9 MW. Further feeder could be arranged for the port with rise in demand and to increase the redundancy of the supply. GPA also advised that they have no policy for capacity limitation on each supply voltage level. The next higher supply voltage level is 34.5kV; however, there is only one client (Navy) for GPA using such high supply voltage level. GPA indicated that a bulk tariff would be applied for the 34.5kV supply level consumer. A sample to illustrate the tariff calculation would be provided for reference.

GPA confirmed that the feeder feeding the port is not under the frequency load shedding scheme. In fact, the supply priority for the port has been set at the same level as for the hospital.

GPA expressed their concern to get the updated electrical loading demand estimate of the port in time to feed back to their plan for power generation upgrade.

GPA also advised that should they opt to use the coal-fired plant, then coal unloading facilities may also be required in the port.



Water Supply & Wastewater

GWA advised that the water supply pipe for the port was fed from two systems, i.e. Navy and GWA. However, GWA indicated that the cost of the water supply from Navy would increase tremendously from \$2.1 to \$4.5 per kgal. GWA is planning to reduce the water supply from the Navy system.

GWA agreed to provide further details on the present water consumption and provision to the port and would also provide single line diagram to illustrate the connection arrangement of the water pipe feeding the port, including the water pipe size and pressure.

GWA advised that the water supply and sewage system upgrade projections have been included in the Master Plan, which is available on their website. However, they would still compile a set of information to illustrate their upgrade projection and provide to PB.

GWA indicated that they have recently incorporated a master water meter for the port water supply that would be able to monitor the total water consumption for the port. GWA expressed their concerns on the water linkage problem for water pipe network inside the port. GWA would compare the sub-metering reading with the recently installed master water meter.

GWA advised that no oiled water would be treated by GWA anymore. An oil water separator would need to be installed to separate the oil from the water.

GWA would provide the capacity of the wastewater pumps in the GWA pump house and the volume of present wastewater discharged from the Port.

GWA agreed to arrange a meeting with their chief engineer for wastewater system should further details on the wastewater system are required.



Port Authority of Guam Master Plan Update

Meeting: **PAG Maintenance Department**

Attendees: Ernest G. Candoleta, PAG Maintenance Manager
Jorge R. Javelosa, E&M Superintendent
Joe A. Ragasa, Superintendent
Ibrahim Soudy, PB
Nelson Wu, PB
LC Wang, PB
KP Leung, PB

Place: GPA conference room

Date: August 10, 2007

Discussion Notes:

The following points have been advised by the Maintenance department of PAG regarding the crane and general E&M systems conditions.

Crane

- There are three Container Cranes and two RTGs in the port.
- The Container Cranes are, in general, 30 years old (1983 for the Hitachi and 1978 for the two Paceco) and are obsolete. There are no spare parts on the shelf on the island, and the parts need to be made to order.
- The average down time for the Container Cranes is 3 to 4 hours per week, and in general, was caused by fault on non major components such as limit switches, etc.
- The last major down time for a Container Crane was about 3 years ago when the main motor on one of the Container Cranes failed. The Container Crane was down for 3 months waiting for the delivery of a new motor.

E&M Systems

- Upgrade of the hydrants, sprinkler and fire alarm system has been completed recently. However, "as built" drawings are still not yet available.
- The load centers LC-1, LC-4 are relatively new installations completed with 500kVA backup generator and ATS. The current loading on LC-1 and LC-4 are about 45% and 55% respectively.
- The load centers LC-2 and LC-4 of (275kVA capacity) are almost fully loaded and will be upgraded to match with LC-1 and LC-4 soon.
- The maintenance team has planned to replace all the main circuit breakers and power panels in the year 2008.
- Underground cables were replaced 2 years ago, and hence the cables should still be in good condition.
- Fire hydrants and sprinklers are directly connected with the water supply main pipe without pumps or tanks.
- There is no direct link between the port fire alarm systems with the local fire station. Fire alarm raised in the port would need to report to fire station by telephone. The closest fire station is 3 minutes away from the port.
- A fire accident happened in the Mobil area (Tank I Farm) about 5 years ago, and lasted for 5 days.
- Presently, there is one fire hydrant not functioning but there is already a contract out to replace it.
- Hose is not in place with each individual hydrant.

- There is no lightning arrestor provided to either the buildings or the cranes. Lightning arrestor may have been installed on the light poles (*Post meeting note: site survey confirmed that no lightning arrestor installed on the light poles*).
- There is one 12" main water supply pipe from GWA feeding the port and another 16" feeding Shell but routed inside the port. Maintenance team recommended that to avoid any possible conflict the water pipe for Shell should be relocated outside the port.
- Currently there is a water outage 3 to 4 times every year and the maintenance team recommended a water tank should be installed for the fire services system.
- There are still some cases with water leakage from the underground water pipes. Whenever water leakage was reported, the maintenance team would assign water leakage detecting company to find out the fault location and have it repaired.
- Gate valves for the underground water pipes are not in good condition; only three valves have been replaced so far. Sometimes water leakage in one section of the pipe may require shutting off more than one valve to stop the leakage.
- As advised by the maintenance department, some of the underground water pipes are still using asbestos.
- Water seepage from the roof is a general problem for all the buildings.
- Blockage of the sewage pipe is very rare, but there were two times caused by someone flushing their underwear in the sewage system.
- Currently the storm drainage is directly discharged to the sea without any treatment, which goes contrary to the existing code, as per advised.
- All repair works for the E&M systems can be traced back from the past work orders, which contained all the details of the repair works done. Maintenance department agreed to provide the work orders for the past two years for PB reference.



Port Authority of Guam Master Plan Update

Meeting: Parks & Recreation / Historical Preservation

Attendees: Vic April, State Archaeologist; Guam Historical Resources Div.
Joe John Mantanona, PB team

Place: Office of the Dept. of Parks & Rec.

Date: August 31, 2007

Discussion Notes:

- In review of the property boundaries within the subject Project site (PAG), V. April noted that there is no issue listed on the Historical Register.
- V. April mentioned that because federal funds are used for the development of the PAG, Sec. 106 will apply.
- Sec. 106 instructs developers who use federal funds to obtain the necessary clearances from the Army Corp. of Engineers (Hawaii).



Port Authority of Guam Master Plan Update

Meeting: **Oceaneer Enterprises**

Attendees: Jurgen Utenburg, Oceaneer Enterprises Inc.
Ibrahim Soudy, PB
Nelson Wu, PB
LC Wang, PB
KP Leung, PB

Place: GPA conference room

Date: August 10, 2007

Discussion Notes

Dr. Utenburg is a Marine Surveyor who has done underwater inspections of the different facilities of the Port of Guam over the years. He has made the following comments and observations during the meeting based on the underwater inspections he has undertaken.

- The sheet piles of the F2 through F6 facilities are damaged extensively at several locations along the length of the berths.
- The damage in the sheet piles is in the form of corrosion, permanent deformations, and openings in between the sheet piles (splits between the sheets).
- The permanent deformations and the openings in between the sheet piles might have been caused by the major earthquake that happened in August of 1993.
- The 1993 earthquake caused significant damage to a portion of the sheet piles and that portion of the facility was replaced by a pile supported concrete wharf.
- The pile supported section of the facility causes waves to go under the dock and disturb the riprap above the fill and potentially the fill itself.
- Facility F-1 berth consists of a number of berthing and mooring dolphins. It is operated by Shell for berthing oil tankers.
- The dolphins are supported on steel pipe piles and have cast-in-place concrete caps.
- Shell has recently undertaken a major retrofitting of the dolphins. The deteriorated portion of each pile was cut and replaced with a new section. The new section was welded to the remaining portion using under water welding. The top of the new pile section was connected to the concrete cap which had part of it recast as well.
- The new sections of the piles were also wrapped in protective sheeting.
- The reports of the underwater inspections conducted by Oceaneer Enterprises Inc. are all available on file in case they are needed.
- The port also should have copies of all the inspection reports on file.



- Copies of two inspection reports of the F-1 facility were provided. The inspections were carried out in 2001 and 2002 and significant damage was reported at that time. The findings of those and similar inspections resulted in Shell doing the recent retrofitting of the dolphins.



Port Authority of Guam Master Plan Update

Meeting: Marianas Express Lines/ CTSI Logistics

Attendees: Ken Constantino, Shipping Department Manager, CTSI
Philip Goh, Port Captain, Mariana Express Lines
Nira Ratnathicam, PB
Paul Sorensen, PB team member
Bob Hrdlicka, PB team member

Place: Port Authority of Guam conference room

Date: August 8, 2007

Discussion Notes

Consultants described the purpose of the interview as an integral part of the information gathering process connected with their work for the Port Authority of Guam Master Plan Update. CTSI and Marianas Express Lines described their business and key issues connected with their port calls on Guam.

- CTSI is a logistics provider that acts as general agent for Marianas Express Lines. In addition, they also provide drayage and other logistics services.
- Marianas Express Lines (MEL) provides weekly service to Guam with 3 vessels of 800 TEU, 850 TEU and 1001 TEU.
- They average 150 – 200 TEU per week inbound and 50 TEU outbound per voyage. 80 % of the containers are 20 footers and 20% are 40's. Approximately 5% – 10% of these containers are reefers.
- MEL is seeing "some increase over the last couple of months." They do not carry any government cargo.
- CTSI and MEL expect a volume increase for the total port of about 50% due the military buildup. However, they are uncertain about any increases to their volume.
- Their main issue in serving any port including Guam is quick turnaround of their vessels. However, they experience delays on virtually every port call on Guam due to shortages of equipment and manpower.
- They have a berth window every Saturday.
- They run a totally grounded operation and average 10 – 12 moves per hour gross productivity on the vessel, however, they can get up to 17 per hour if everything goes right.
- Their average dwell time is about 3 days.
-
- MEL has ample unutilized vessel capacity so they are not concerned about volume increases and would welcome it.
- CTSI operates and off dock CFS.



Port Authority of Guam Master Plan Update

Meeting **Port of Guam Commercial Facilities Field Tour**

Present: John Santos, PAG Operations Manager & Staff

PBI Team Members:

Ibrahim Soudy

Nelson Wu

KP Leung

LC Wang

Bob Hrlicka

Paul Sorenson

Joe John Mantanona

Nira Ratnathicam

Place: Port of Guam Terminal Facilities

Date: August 7, 2007

Notes

John Santos and members of his staff conducted a tour of the terminal area for the PBI Master Plan team members. A total of about one hour was spent on the tour. After completion of the tour the PBI Team facility specialists conducted a more in-depth tour in order to assess the type and condition of facilities. Description of this subsequent assessment is not included in this document but is included in other notes. The following miscellaneous topics related to the various terminal areas were discussed during the tour.

- Proposed F-7 Wharf Expansion Area: There is a coral bed located offshore from this location. However, recent test had shown that the coral was dead.
- There is recent interest in locating a coal fired power plant near the port. Under this proposal, material would have to be unloaded at the port and conveyed to the site.
- Visited the Warehouse area where long-line tuna support operations are currently underway by port tenants. The 1999 Master Plan recommended relocation of these tenants to the Hotel Wharf property which is currently under lease to YTK. However this relocation had not taken place.
- Break-bulk cargo handling: After the last Typhoon, there was a surge of break bulk cargo to support restoration work. This impacted port operations.
- Visited the old CFS, de-vanning, maintenance areas. Port staff prefers relocation of these functions outside the port area due to modern security considerations.
- Container Yard: Predominantly a wheeled operation. Three Container Cranes at berths but only two are operational. Two RTG's at end of yard are used on a limited basis for grounded operations. See other meeting and discussion notes for more detail on cranes and other equipment.
- Gate Area: Manual gate operation with three inbound and one outbound lanes and building.
- The Reefer slot area is located along the fence line near the main road. Reefer stations are all 220/440 volt outlets. The Port Authority of Guam has a total of 95 reefer outlets (56 (240V), 39 (440V)), with work underway to install an additional 25 (440V) outlets. PAG indicated that dwell times varied from 2 days to 7 days. More specific dwell time records will be provided later based on specific type of container.
- Visited the recent expansion area where we the port had created additional paved area to receive autos and other vehicles.



- See facilities meeting discussion and description for additional details on the commercial port facilities.



Port Authority of Guam Master Plan Update

Meeting: Shell Oil

Attendees: Glenn Leon Guerrero, Chairman, Shell Oil
Al Leon Guerrero, Matson Navigation
Paul Sorenson, PBI Master Plan Team
Bob Hrdlicka, PBI Master Plan Team
Nira Ratnathicam, PBI Master Plan Team

Place: Port of Guam Administrative Offices

Date: August 9, 2007

Discussion Notes

Shell leases the F-1 pier from the port on a long term lease. With respect to the base relocation demand for petroleum products, Shell has more than enough storage and berth capacity to address the additional requirements. Current berth utilization at F-1 is not high and is in the lower double digit range. Shell has 250,000 barrels of storage capacity. This is Shell's own offsite storage form to which refined petroleum products are pumped.

Shell discussed the need for repair of the fuel line running through port property. There are 2-16" and 2-24" lines. One of the 16" lines is not used.

Under the terms of the lease the Port performs upgrade and maintenance. Shell is currently making arrangement to perform work on the line since funds for not available for port repair of this line. It has ordered steel and plans to make repairs in November. The fuel line runs through the container yard.

The Port owned tank farm is leased and managed by Mobil.



Port Authority of Guam Master Plan Update

Meeting **Chamber of Commerce, Maritime Affairs Committee**

Present: Glenn Leon Guerrero, Chairman, Maritime Affairs Committee
Al Leon Guerrero, Maritime Affairs Committee
Paul Sorenson, PBI Master Plan Team
Bob Hrdlicka, PBI Master Plan Team
Nira Ratnathicam, PBI Master Plan Team

Place: Port of Guam Administrative Offices

Date: August 9, 2007

Discussion Notes

The Maritime Affairs Committee (MAC) of the Chamber of Commerce includes members from Port stakeholders and other government agencies such as the Coast Guard, Guam Customs and private sector stakeholders such as Shell and Matson. It also includes subcommittees as needed to provide an interface with specific elements of Port operations. For example a Trucking Sub-committee was established when there was need for focus in this area. The MAC committee meets once a month and focuses on issues such as formulation of recommendations for legislation related to Port business.

The MAC committee also works on identifying funding issues such as availability of Federal funds. Discussion also centred on recent identification of USDA funds to partially support the purchase of container cranes. Also works closely with GEDCA.

The committee members emphasized the need to improve efficiencies at the port in order to address upcoming demands from the base relocation. They also emphasized the need to establish a plan for modernizing and expanding the port quickly and begin the work program necessary so that Guam will be able to handle the cargo associated with the base relocation.

The attendees discussed examples of previous DOD base construction and personnel relocation efforts such as Red Horse which involved the construction of some 200 plus housing units.

The attendees discussed the fact that virtually everything necessary to complete the upcoming marine forces transfer from Okinawa will come from outside Guam, including workers under the Federal Government's H2 temporary worker program. There were numbers ranging from 18,000 to 22,000 discussed by the group. During the Vietnam war there were at one time up to 38,000 defence personnel stationed on Guam.

Matson has expended US\$550 Million on 4 new vessels for the China service which makes weekly calls at Guam. It is possible that there could be other Asian carriers who would begin calling during the construction phase to support movement of Japanese funded goods. However this was unclear at this time.

Discussed the September 13, 2007 MAC sponsored port development conference and for PB representation at the conference.



Port Authority of Guam Master Plan Update

Meeting: E-mail Correspondence with U.S. Coast Guard

Attendees: Jeffrey Neumann, USCGC Sequoia Commanding Officer
Ralph Peterreit, PB

Date: September 6, 2007

Place: Via E-mail

From: jNeumann@cgsequoia.uscg.mil on behalf of Neumann, Jeffrey LCDR
[jNeumann@cgsequoia.uscg.mil]
Sent: Thursday, September 06, 2007 3:13 PM
To: Peterreit, Ralph
Subject: RE: Guam WAMS

Ralph,

First, hello and thanks for the note. Collin Bronson, who you info'd is no longer the operations officer, so you probably got a kick back on his e-mail.

As you're an engineer, you'll probably find our WAMS process to be fairly un-scientific (we're merely a bunch of ship drivers!). Every 5 years or so, we advertise in the notice to mariners that we're conducting a survey and give people the opportunity to comment (similar to the process to build a bridge, or modify something in a port). We follow that up with mailed or e-mailed surveys to the known waterways users, the big partners that we know

of: pilots, tug companies, tour companies, other government agencies, etc.

After the deadline has passed, we compile the information and write a report that summarizes the current state of the aids, waterway, and any proposed changes.

We're actually behind with Guam, our thought was to get it done in the spring (which is why we advertised it in February, as you noted), but we got caught up with some other stuff, then we had transfer season, and now we're in Hawaii conducting bi-annual training with the Navy. So, what we'll have to do when we get back is probably advertise and start over again.

However, I think I can safely answer your questions, mostly due to the fact that we rarely receive any comments on any WAMS. So, the short answer to your e-mail is:

1. We were working on it, but have been over taken by other events. We'll return full force in a month or so.
2. As far as I know, we have received no comments from either the Notice to Mariners, or surveys.
3. None, but I'll double check.
4. I end up commenting on any comments made, then make a recommendation to the District (my supervisor) to go with them or not. As I'm sure you know, any changes within marine environment don't happen quickly. Cost, environmental impact, feasibility, responsibility, all are taken into account. The final decision rests with the District.

WAMS are more of an informational document, not so much a planning tool, although sometimes in comments you hope to get agencies' future plans.



For example, it would be nice if the Navy would let us know their anticipated increase (or decrease) in vessel traffic and type. A comment on that would prompt me to recommend status quo, or a change to the waterway, and the District would evaluate. Another example is the Port of Tinian. They recommended a range be added to the channel due to the frequency of the buoys being washed off station and it sometimes takes us weeks to get up there and replace them. The range would allow them to continue limited use of the channel without buoys. That recommendation has actually been sent forward for study to determine cost & impact.

So, that's probably a longer answer than you were looking for. In a nutshell, we're kind of in the middle of the WAMS, but I don't anticipate any off the wall comments or recommendations, although I'm fairly certain there will be big changes to both the Navy and commercial side of the port.

Any information you care to provide is appreciated, you can just e-mail me.

I'll look around for one of our surveys (the current OPS is on emergency leave) and forward that to you so you can see what we're looking for. I'll also dig up a recently completed WAMS for Saipan/CNMI so you can see what goes in it. Again, it's not a real scientific study, more of an overview.

Personally, having worked the harbor for two years now, I'm not sure from an aids to navigation standpoint if there is much improvement to be done.

Obviously, if the Navy or commercial port were going to add piers, or dredge new channels, then some things would change. There's a totally separate process for that (as I'm sure you know), that we would be involved with to determine if it changes the aids to navigation system.

Best regards,
Jeff
LCDR Jeffrey Neumann
Commanding Officer
USCGC SEQUOIA

-----Original Message-----

From: Petereit, Ralph [mailto:Petereit@pbworld.com]
Sent: Thursday, September 06, 2007 11:32 AM
To: JNeumann@cgscsequoia.uscg.mil
Cc: CBronson@cgscsequoia.uscg.mil
Subject: Guam WAMS

Jeff,

Your name and e-mail address were provided to me by Capt Bill Marhoffer. I am working with the Port of Guam to update their Master Plan. As part of that work I need to address the aid to navigation system, in particular the aids that are at the entrance to and within Apra Harbor, as well as the aids at the entrance to Hagatna and Agat boat basins. I understand that you are conducting a WAMS for Guam. The latest information that I received from BM1 Calloway at Sector Guam was that a Local Notice to Mariners dated February 6, 2007 was issued requesting comments for the Guam WAMS study. BM1 Calloway did not know the status of the study. My questions are as follows:

1. What is the status of, and schedule for, the WAMS analysis for Guam?
2. Have you received comments relating to the island of Guam?
3. What are those comments?



4. Will, or have, any of the comments resulted in changes to the Guam WAMS?

Your assistance with these questions would be appreciated.

Ralph Petereit, PE
Senior Project Manager

.....
PB
999 Third Avenue, Suite 2200
Seattle, WA 98104-4020

Direct: 206-382-8306
Fax: 206-382-5222
E-mail: petereit@pbworld.com

www.pbworld.com <file://www.pbworld.com>

NOTICE: This communication and any attachments ("this message") may contain confidential information for the sole use of the intended recipient(s). Any unauthorized use, disclosure, viewing, copying, alteration, dissemination or distribution of, or reliance on this message is strictly prohibited. If you have received this message in error, or you are not an authorized recipient, please notify the sender immediately by replying to this message, delete this message and all copies from your e-mail system and destroy any printed copies.



Port Authority of Guam Master Plan Update

Meeting: Marina Fishing Port User Representatives

Attendees: Dan Ridlon, Recreational Boating Representative
Masao Tembata, Ten Boat Charter
Steven Kasperbauer, Alupang Beach Club
Roy Brown, Sea Spinner; Sea Odyssey
Ralph Peterreit, PB
Peter Blaz, PAG, Hagatna Marina Manager

Place: Port Authority of Guam Conference room

Date: August 29, 2007

Consultant opened the meeting with a brief discussion of the master plan update and the purpose of the meeting; and solicited input from the users of the Hagatna and Agat Marinas, as well as the Harbor of Safe Refuge.

The floats in Hagatna marina are extremely deteriorated and need to be replaced. Material other than wood should be considered. Wood does not hold up well in this environment.

There is a need for a bathymetric survey in Hagatna Marina. There is a coral head in the channel near the police boat that boats can hit when the tide is low. There is also one near the boat ramp by the street. In addition, there is sand build-up at the storm water outflow into the basin. The boat basin needs to be dredged to a uniform depth.

Out of the 1 million plus visitors to Guam there are about 300,000 that will get onto a boat. They board the boats at Hagatna and Agat marinas. The boarding areas need to be safe and attractive to tourists.

There is a need for a covered bus passenger holding area where tourists can wait for their bus. This will protect them from rain and sun until their bus comes.

There is a need for competitive fueling options. Fueling is an issue to some. Currently there is only one vendor at Hagatna, and that is through the fisherman's co-op. At Agat, the fuel pier is unsafe and they no longer have fueling there. There is a fuel truck from MDA that comes out on Mondays and Fridays but you have to be there when they are or you miss out on fuel delivery. Fueling of recreational craft is an issue. The logistics of the fueling site is an issue. There is only a ladder getting you up from the floating fuel dock to the pier.

The guide piling at the marinas are too short. During the last large typhoon, the floats rode up and hung up onto the tops of the guide piles. The piles need to be extended and made taller.

Guam Law (Public Law 17 – 71) limits the size of vessels in Hagatna Boat Harbor to 55 feet in length. [Statement not verified]

The Master Plan needs to address the growth in use of personal watercraft.

Need to regulate what levels of boat repair are authorized at each marina.



There needs to be a way to haul out a large fish caught on a charter fishing boat without having to wait at the fuel pier, which is often congested.

The fueling and ice unloading is “monopolized” by the fisherman’s co-op. They get this exclusive vendor service at a cost of \$1/year for a period of 50-years. [Lease agreement not verified]

The Consultant team should look up the lease for the fisherman’s co-op.

The lease rate for a pleasure boater should not be the same as that for a commercial vessel.

At Hagatna, it can take years to get a slip. While there is a waiting list, it is not maintained nor are the rules for filling vacancies clear or followed (i.e.: person waiting the longest does not get the first opportunity when there is a vacancy). The waiting list is essentially non-functional because slips rarely turn over. Corporations own many of the vessels and these don’t turn over. Having a slip at Hagatna is a valuable asset.

The language of slip leases needs to deal better with termination clauses.

There is a need for clean restrooms. The restrooms at Hagatna are so bad that tourists are advised not to go in them.

At Hagatna, the Port should consider acquiring more land for expansion.

Security is a problem at both marinas. At Hagatna, the gates are never locked. At Agat, the kids just swim around the fences and get up on the docks. There have been thefts and destructive vandalism. Need better security.

A sewage pump out is needed at Agat marina (there is one at the co-op facility in Hagatna).

There needs to be a launch fee at each of the marina boat ramps.

At Agat, the breakwater was never finished. As a result, there is a lot of silt and sediment buildup at the north end, so much so that the slips at that end can only be used by smaller boats. During extreme tidal surges, the water races through the marina. The floats are very light duty, not built at all for a marine environment that can be subject to severe storms.

Except for the entrance buoys, the aids to navigation into the boat basin are privately maintained. When they are damaged, it takes a long time to get them repaired/replaced.

Harbor of Refuge

The mooring at the Harbor of Refuge are in extremely bad condition. Some are unsafe and need replacing. These have been in place for 17 years and the steel in them has corroded away so that there is nothing to tie to. This will be a problem during the next typhoon. There is room for 53 or 54 boats, but only space for 25 boats have secure moorings.

There should be a cooperation agreement with the Navy or Air Force to keep the boats in the event of a typhoon, because the Harbor of Refuge will not be able to handle all of the requests.

Some have suggested the acquisition of a travel lift, especially at the Harbor of Refuge. This would make it easier to haul out vessels for their Coast Guard mandated inspections.



Port Authority of Guam Master Plan Update

Meeting: Coast Guard (Aids to Navigation)

Attendees: BM1 Calloway, Ralph Petereit, PB

Place: Coast Guard Sector Guam Building 2

Date: August 27, 2007

Consultant opened the meeting with a brief discussion of the master plan update and the purpose of the meeting; and solicited input from the Coast Guard on Aids to Navigation at the marinas.

BM1 Calloway is the secondary aid to navigation contact at Coast Guard Sector Guam. The primary contact is the Coast Guard Cutter Sequoia. This buoy tender is currently in Hawaii undergoing training with the Navy and is unavailable for questioning.

Agana Boat Basin

There are two entrance fixed aid to navigation structures. These frequently go out. There is also a channel range with fixed dayboard structures. The front is at 19 feet and the rear is at 37 feet.

Agat Boat Basin

There are three federal buoys here. Every 6 years or so the Alpha buoy gets washed ashore. There are several private aids to navigation owned by the Government of Guam. The police department maintains these. Contact is Brad Hokinson (671) 475-8447.

Apra Harbor

The buoys and three sets of ranges are in good condition here. All aids are federal with the exception of some private aids going up Piti channel into the power plant.

The CGC Sequoia is currently conducting a WAMS analysis in Guam. They should be contacted for additional aids to Navigation information.

CONFIDENTIAL INFORMATION
NOT INCLUDED IN PUBLIC REPORT

CONFIDENTIAL INFORMATION
NOT INCLUDED IN PUBLIC REPORT



Port Authority of Guam Master Plan Update

Meeting: Watts Constructors

Attendees: Bill Beery, General Manager
Roy Patten, VP Operations
Nira Ratnathicam, PB Team
Paul Sorensen, PB Team

Place: Watts Constructors

Date: September 9, 2007

Consultants opened the meeting with a brief discussion of the master plan update and the purpose of the meeting; and solicited input from Watts.

Watts is involved in construction projects at Andersen AFB (value ~\$30 million) and on the Navy project (value ~\$80 million).

They are working with Perez Brothers on the Navy project – 102 structures (204 units – all are duplexes). Perez has a batch plant on site. The units are being built as concrete cast in place structures. All work is done on site. They think this is the best method of construction for the Marines project.

On the Navy project, they are working with Hawaiian Rock, with a similar process.

They mentioned that they have run out of cement five times so far on this project.

Much of the internal product is containerized and comes from the US West Coast (cabinets, sinks, tile, drywall, HVAC piping, appliances, etc). Most is containerized except for long beams (oversize and on flat racks). They estimated 700 to 800 containers for the two jobs. For Andersen, they have received 12 loads of steel – there will be 60-70 loads total with 45,000 to 50,000 pounds per load.

Aggregates are available on Guam. Hawaiian Rock and Perez have quarries and have applied for permits. The best product is at the north-end of the island. They don't think aggregates will be a problem but there is a need for more pits or expanded pits.

They estimated there were 4,000 local construction workers now and will add 1,000 locals to the force but most additional labor will come from off island.



Port Authority of Guam Master Plan Update

Meeting: Guam Visitors Bureau

Attendees: Ana Cid, Research & Statistics Analyst
Paul Sorensen, PB Team

Place: Guam Offices

Date: September 12, 2007

Consultants opened the meeting with a brief discussion of the master plan update and the purpose of the meeting; and solicited input from GVA. Specifically sought info regarding cruise vessel ops and tourism.

Ana provided data on passenger vessel trends for past five years. She noted that the stats include all passenger boat activity (could be a private yacht).

BST joined the GVA and she explained other sources of data that would explain visitor trends.

She also recommended looking at the Hawaiian Tourism Assn for their cruise studies...



Port Authority of Guam Master Plan Update

Meeting: Guam Power Authority

Attendees: John Cruz, GPA Strategic Planning
Jennifer, GPA
Frances, GPA
Paul Sorensen, PB Team

Place: Guam Power Authority offices

Date: September 9, 2007

Consultants opened the meeting with a brief discussion of the master plan update and the purpose of the meeting; and solicited input from GPA. Specifically, we sought input for forecasts.

GPA has recently worked with Dr Kemm Farney to update their forecast model for their strategic plan. They are awaiting the final write-up. They provided his e-mail address:

Kemm C. Farney, PhD
President
P&L Economics, Inc.

PO Box 561
Newtown Square, PA 19073-0561
(Philadelphia)

610-356-4677
kemm.farney@comcast.net

GPA has 550 MW capacity with a current peak of 280. They will need up to 120 MW for the military. The Navy also wants a larger volume of backup materials (inventory) than GPA currently maintains. This could increase storage requirements.

They have evaluated several ways to expand capacity and are going to present results in community meetings. One of the options is a coal-fired plant. If this were chosen, they would need land for the plant.



Port Authority of Guam Master Plan Update

Meeting: Black Construction

Attendees: Leonard K. Kaae, Sr VP & Gen Mgr
Paul Sorensen, PB Team

Vince Munoz, PB Team

Place: Black Construction

Date: September 12, 2007

Consultants opened the meeting with a brief discussion of the master plan update and the purpose of the meeting; and solicited input from Black.

Black has a 50 year history of construction on Guam and in the islands.

They think cast in place is the best method of construction for the Marines project. The additional cost of re-handling the products is too expensive.

They estimated the local construction work force would be 5,000 to 6,000 to serve the DOD. Would need ~15,000 workers from the Philippines.

Port Authority of Guam Master Plan Update



Meeting: PAG Operations

Attendees: John Santos, PAG Operations Manager
Bob Hrdlicka, PB Master Plan Team

Place: PAG Office

Date/Time: September 12, 2007, 11:45 AM

The purpose of the meeting was to confirm current equipment inventory, discuss remaining useful life and review other operational issues.

- John provided a matrix which shows estimated remaining useful life of the current equipment inventory.
- There was a discussion of the issues surrounding wheeled vs. grounded yard operations. John's concern on a grounded operation is interference between outside trucks picking up or delivering cargo and truck trying to service the vessel.
- John's original plan was to go 80% grounded and 20% wheeled, but now are looking at keeping the status quo, i.e., 80% wheeled and 20% grounded.
- Kyowa Shipping is the only break-bulk carrier currently calling at PAG. They use berth F-4 and do both break-bulk and containers on their vessels.
- PAG is currently running 14,000 lifts more volume YTD than at this time last year.
- PAG is looking to replace their computer system next Fiscal year and have budgeted for it.



Port Authority of Guam Master Plan Update

Meeting: PAG Equipment Maintenance Staff

Attendees: Ernest Candoleta, Maintenance Manager
Two other members of the PAG Maintenance Staff
Bob Hrdlicka, PB Master Plan Team

Place: PAG office

Date: September 12, 2007

The purpose of the meeting was to update the PAG current equipment list and to discuss maintenance issues.

- The equipment list was presented by PAG staff. The information on the list was reviewed in detail and will be used to update the equipment matrix prepared by consultants.
- Plan to replace lift trucks in the current fleet with the following: 6 – 5 ton lifts, 2 - 7.5 ton lifts, 1 – 10 ton lift and 1 – 20 ton lift. All but 2 of the current fleet of lift trucks have 1 year or less of useful life remaining.
- PAG currently has 4 generators: 2 – 500 kw and 2 – 275 kw. Staff feels that the 2 – 275 kw generators need to be upgraded to 500 kw each.
- The environmental conditions at PAG tend to shorten the useful life of equipment due to the salt air and acid rain caused by the power plant adjacent to the facilities.



Port Authority of Guam Master Plan Update

Meeting: PAG Lease Review

Attendees: Glenn Nelson, Commercial Manager, PAG
Bob Hrdlicka, PB Master Plan Team

Place: PAG Office

Date/Time: September 12, 2007/3:45 PM

The purpose of the meeting was to update the preliminary review of leases done as a part of Task #7 of the consultants' scope of work.

- The original Casamar lease was done between Casamar and Guam Economic Development Authority (GEDA), now called GEDCA. Subsequently PAG assumed the lease. Glenn will provide a copy of the original lease for review.
- Glenn will provide a map, in electronic form, showing how all the old GEDA tracts are currently divided.
- The location of the Shell pipeline was discussed. Glenn advised that PAG has the right under the lease to require Shell to relocate the pipeline at Shell's expense.
- Glenn to provide sketches, in electronic form, of the warehouses and the open area near the gate showing the location of tenants in those areas.
- A potential tenant for cement imports wants to lease a piece of land near the seaplane dock on a turnkey basis to develop an import cement facility. However, PAG feels that they cannot offer a lease to this customer since the current master plan describes the area as "possible industrial or recreation." Because it is now used by the public for recreational purposes, PAG feels that they would challenge such a change in use.
- The water depth at the Hansen Cement facility was discussed. It is Hansen Cement's responsibility to dredge their own berth.



Port Authority of Guam Master Plan Update

Meeting: Horizon Lines

Attendees: Dave Tokeshi, Vice President/ General Manager, Horizon Lines of Guam
Bob Hrdlicka, PB Master Plan Team

Place: Hilton Hotel ballroom following the Port Development Conference

Date: September 14, 2007

This was an informal ad hoc discussion immediately following the conference.

- Dave advised that in the spring of 2007, Horizon Lines changed their vessels and rotation into Guam.
- Under the old scheme, they used 2000 TEU vessels on a rotation of: Tacoma, Oakland, Honolulu, Guam, China, and Tacoma. On that service, they allocated 600 TEU for Guam and 1400 TEU for Honolulu leaving the USWC.
- Under the new deployment scheme, they are using 2800 TEU vessels on the same rotation of port calls, however, they take no cargo for Honolulu off the west coast since, unlike the ships used in the old deployment, and the new ships are not "Jones Act" ships, even though they are American flag. Therefore they cannot take cargo to Hawaii off the USWC, although they can to Guam. This means that the former Hawaii space allocation is available for full W/B containers going to Guam. They still call in Honolulu with these vessels, but only to load empty Maersk containers destined for China, which is permissible under the cabotage laws.
- The message from the above discussion is that Horizon feels that they will have ample space available to handle additional cargo to Guam to accommodate the growth due to the military buildup.
- While Horizon doesn't like providing chassis, they are concerned that PAG would not be able to handle a grounded operation efficiently.
- PAG still prepares EIR's and hand delivers them to Horizon 2 times per day where a Horizon clerk enters the data into Horizon's computer.
- Dave feels that PAG could probably get by with used cranes rather than new ones if they could find some with at least 5 – 10 years of useful life left. This would buy time to handle the military surge and then the used cranes could be replaced with new ones in the future.



Port Authority of Guam Master Plan Update

Meeting: Long-liners & Fishermen's Cooperative

Attendees: Manny Duenas, Guam Fisherman's Cooperative
Mr. Tom Cepeda, Tidewater
Nira Ratnathicam, PB Master Plan Team

Place: Port Offices

Date: September 12, 2007

F-3 Tenant Facilities

Mr. Cepeda expressed the concerns of the Long-liners currently operating out of Warehouse #1 and #2 within the Commercial Port area. The discussions are summarized as follows.

- Mr. Cepeda was in the process of setting up a tenant organization of long-liners. He subsequently e-mailed a document with the signatures of the members of the organization. Copy on ProjectSolve site.
- Warehouse #1: The group is opposed to any move from the area.
- The current master plan proposed relocating the tenants to Hotel Wharf which under a long term lease to YTK. The group views YTK as a competitor and the terms that it anticipates receiving from YTK they expect would force them out of business or relocate to other islands.
- Both gentlemen contended that YTK had not met their obligation under the lease with the Port and this made relocation to Hotel Wharf more untenable.
- Tidewater has invested in installing cold storage rooms in Warehouse#2 and has not amortized the investment as yet. It would be a financial burden for them to relocate at this time.
- The long-liners use 75' to 100' boats with drafts of 15' to 20'. It brings in Tuna to F-3 and sometimes must double berth its vessels. Catch sizes vary normally from 5 Ton to 35 Tons but could reach as high as 50 Tons. It takes about 3 to 5 hours to offload. The prime portions are packed in ice and air freighted to Japan. The reject fish not sent to Japan is offloaded to the adjacent operation at United Fisheries and processed for local consumption.
- Discussed how fisheries were much higher in 95 but only about 100 boats come to Guam now due to coast guard enforcement of immigration regulations applicable to the crew and other factors.
- Bunkering services are provided by Shell.
- FSM boats use the facilities due to the 3 to 4 daily flights out of Guam which are not available in other islands.
- The tenants would like to be part of the planning process.

Agat Marina

- Mr. Duenas represented the Fisherman's Cooperative which uses the marina for fishing. The marina is also used for recreational purposes related to tourism.
- He complained about the lack of maintenance at the marina. The north-side of the causeway should not have been removed. Siltation is a problem.
- There is no place to put 50' plus boats in the marina.
- Agat was meant to be for community based use and not planned for these boats.



- The commercial users of the marina do not mind a user fee provided that proper maintenance and facilities are provided in return.



Port Authority of Guam Master Plan Update

Meeting: Long-liners & Fishermen's Cooperative

Attendees: Frank Santos, Harbor Master
Nira Ratnathicam, PB Master Plan Team

Place: Port Offices

Date: September 12, 2007

- The Harbor Master's office provides marine traffic control in Apra Harbor 24/7 and includes both commercial and navy vessels.
- It coordinates vessel operations and assigns berths when vessels arrive in harbor. Meetings are held five days a week with representatives from the various harbor users attending.
- Three pilots are available with Tugs available from Cabras Marine. The tugs include two 2600 HP and two 3,200 HP tugs. They generally use two tugs for most vessels but sometimes for aircraft carriers four tugs are needed. Horizon ships have bow thrusters and normally need only one tug except when it is windy.
- Any vessel over 500 GRT requires a pilot.
- Fishing vessels need a pilot the first time that they ever come to Guam for orientation purposes and after that they do not normally need pilotage.
- Class C-9 and C-10 are ok to handle at the berths but class C-11 vessels have facility draft limitations.
- There is dead coral 115' out from the #23 Bollard on F-6.
- Santos does not see any limitations on the distance between the commercial berths and the Navy wharf some 750' across the slip. There is sufficient room for tug maneuvering when bringing vessels in. Vessels are first turned in the harbor and backed into the berth.



Appendix 1-3 Data Collection

The following is a summary of the various types of data that were collected during the assignment.

Table A1.3-1 List of Collected Data

Port Facility or Report Topic	Information	Status		Comments
		Rec.	Date	
1 Task 3 Pertinent government agencies	EIS Kilo Wharf Extension	X	07/09/07	Navy expansion across slip
2 Task 3 Pertinent government agencies	2005 Guam Statistical Yearbook Release 4	X	07/09/07	
3 Task 3 Pertinent government agencies	2005 Guam Statistical Yearbook Release 1	X	07/09/07	
4 Task 3 Pertinent government agencies	Planning for Military Growth	X	07/09/07	Guam Civilian Military Task Force - Governor's Office
5 Task 4 DOD	Joint Guam Program Office Update	X	07/09/07	P/P Presentation from DC Aug 07
6 Task 1 Port Interviews	Master Plan Questionnaires	X	09/07/07	Harbor Master
8 Task 2 Port user groups	Guam Saipan Sailing Schedule	X	09/07/07	Operations manager Horizon Lines
9 Task 2 Port user groups	Employee Count FY2007	X	09/07/07	
10 Task 2 Port user groups	Organizational Chart 2007	X	09/07/07	
11 Task 2 Port user groups	Staffing Pattern 2007	X	09/07/07	
12 Task 7 Agreements	Subic Crane Agreement	X	09/07/07	
13 Task 3 Pertinent government agencies	Guam DVD	X	09/07/07	
14 Task 3 Pertinent government agencies	Protect Our Reefs, Coastal management plan, Seashore Management Plan, Development requirements Guam	X	09/07/07	
15 Task 3 Pertinent government agencies	Management Audit 2000	X	09/07/07	
16 Task 4 DOD	Leo Palace Marketing Plan	X	09/07/07	Industry Development Specialist Guam Economic Development and Commerce Authority 590 South Marine Corps Drive Ste 511, ITC Bldg. Tamuning, GU 96911 Tel: (671)647-4332 Fax: (671)649-4146
17 Task 4 DOD	SDDC Brochure	X	09/07/07	SDDC: Military Surface Deployment and Distribution Command
18 Task 6.1 Examine Infrastructure	Existing Cranes Information	X	09/07/07	
19 Task 6.1 Examine Infrastructure	Geotechnical Status Report -June 10,1994	X	09/07/07	Description of report on ProjectSolve site

Table A1.3-1 List of Collected Data (Continued)

	Port Facility or Report Topic	Information	Status		Comments
			Rec:	Date	
20	Task 6.1 Examine Infrastructure	Oceaneer Enterprises Inc. Underwater Inspection Reports of F3 2006	X	09/07/07	Done to see if there is oil leakage in wall, Description of report on ProjectSolve site
21	Task 6.1 Examine Infrastructure	2006 Equipment Maintenance Quadrennial Inspection Discrepancies	X	09/07/07	
22	Task 8 Facility Utilization	Historical Service Logs	X	09/07/07	Harbor Master
23	Task 8 Facility Utilization	Cargo Statistics	X	09/07/07	Total Cargo statistics for Guam 2000-2006
24	Task 8 Facility Utilization	Container Forecast	X	09/07/07	
25	Task 13.1 Port Security	Ports & Customs Information	X	09/07/07	
26	Task 3 Pertinent government agencies	Navy Execution Plan	X	09/07/07	Navy Execution Plan from Vincent Munoz
27	Task 5 Forecast	Annual Census of Establishments Release Rev 082807	X	09/07/07	
28	Task 6.1 Examine Infrastructure	Crane Bid Specification	X	09/07/07	
29	Task 6.1 Examine Infrastructure	Port water Consumption	X	09/07/07	PORTCONS.pdf
30	Task 2 Port user groups	Dept. of Labor June 2007 Employee record	X	09/07/07	cesjun07.pdf
31	Background	Deep Water Wharf EIS	X	09/07/07	
32	Task 12.1 Marinas	Guam _ AGANA Boat Basin Regulations	X	09/07/07	
33	Task 12.1 Marinas	Guam _Harbor Refuge Application	X	09/07/07	
34	Task 12.1 Marinas	Guam - Public Law 17-071	X	09/07/07	
35	Task 12.1 Marinas	Guam - Repair Permit	X	09/07/07	
36	Task 12.1 Marinas	Guam Marina Proposed Rules	X	09/07/07	
37	Task 3 Pertinent government agencies	Proposed Legislation developments	X	09/07/07	Bill Nos. 146, 160, 165-PAG relates.pdf
38	Task 3 Pertinent government agencies	EIS Info from CORPS	X	09/07/07	
39	Task 6.1 Examine Infrastructure	PAG Drawings for Commercial port	X	09/07/07	Drawings & Plans for commercial port
40	Task 6.1 Examine Infrastructure	PAG Drawings for Cantainer yard Expansion projects	X	09/07/07	Drawings & Plans for container yard expansion projects
41	Task 6.1 Examine Infrastructure	PAG Drawings for Electrical Sub-Station upgrade project	X	09/07/07	Drawings & Plans for Electrical Sub-Station upgrade project
42	Task 6.1 Examine Infrastructure	PAG Drawings for Liftech	X	09/07/07	Drawings & Plans for Liftech

Table A1.3-1 List of Collected Data (Continued)

	Port Facility or Report Topic	Information	Status		Comments
			Rec:	Date	
43	Task 3 Pertinent government agencies	Study of economic impacts of tourism done by Global Insight	X	09/07/07	Mentioned during Meeting with Department of Labor
44	Task 3 Pertinent government agencies	GPA Presentation to S&P	X	09/07/07	Mentioned during Meeting with Department of Labor
45	Task 6.1 Examine Infrastructure	As-built drawings for Route 11 & 18 and Route 1			Expected from DPW
46	Task 6.1 Examine Infrastructure	Guam Master Plan 2020 section related to road condition			Photocopy Expected from DPW
47	Task 6.1 Examine Infrastructure	Details from GPA and single line diagram to illustrate the connection arrangement on the distribution side for the feeder feeding the port.	X	09/07/07	Mentioned during meeting with GPA
48	Task 6.1 Examine Infrastructure	GPA Powerpoint presentation to Navy			Mentioned during meeting with GPA
49	Task 6.1 Examine Infrastructure	GPA Sample bulk tariff calculation			Mentioned during meeting with GPA
50	Task 6.1 Examine Infrastructure	GWA Single line diagram illustrating the connection arrangement of the water pipe feeding the port			Mentioned during meeting with GWA
51	Task 6.1 Examine Infrastructure	Capacity of the wastewater pumps in the GWA pump house			Mentioned during meeting with GWA
52	Background	Aerial Photos of the port & facilities (color high res preferred)	N		None were received, using Google downloads.
53	Background	Land Use Map and Zoning designations	N		None received, use sketch from Port Website to recreate.
54	Task 2 Port user groups	Horizon Lines 2006 Annual Report	X	09/07/07	
55	Task 2 Port user groups	Matson Transportation Presentation	X	09/07/07	
56	Task 7 Agreements	Guam Transport WH	X	09/07/07	
57	Task 7 Agreements	Guameco Corp.Parcel3.HW	X	09/07/07	
58	Task 7 Agreements	Guameco Corp.WH1.B5&6	X	09/07/07	
59	Task 7 Agreements	GYTK	X	09/07/07	
60	Task 7 Agreements	Horizon Lines	X	09/07/07	
61	Task 7 Agreements	Matson.Admin.Ste103.104	X	09/07/07	
62	Task 7 Agreements	Matson.AdminBldg	X	09/07/07	

Table A1.3-1 List of Collected Data (Continued)

	Port Facility or Report Topic	Information	Status		Comments
			Rec:	Date	
63	Task 7 Agreements	Matson.Amendment	X	09/07/07	
64	Task 7 Agreements	Matson.CFS	X	09/07/07	
65	Task 7 Agreements	Matson.Parcel1	X	09/07/07	
66	Task 7 Agreements	Mobil Oil.Assignment	X	09/07/07	
67	Task 7 Agreements	Mobil Oil.Mgt Agreement	X	09/07/07	
68	Task 7 Agreements	PDD	X	09/07/07	
69	Task 7 Agreements	Shell.Bunker Line	X	09/07/07	
70	Task 7 Agreements	Shell.DogLeg Pier	X	09/07/07	
71	Task 7 Agreements	Shell.Extend Easement	X	09/07/07	
72	Task 7 Agreements	Shell.Finger Tip	X	09/07/07	
73	Task 7 Agreements	Shell.Main Pipeline	X	09/07/07	
74	Task 7 Agreements	SPPC	X	09/07/07	
75	Task 7 Agreements	TideWater.WH1.B3&4	X	09/07/07	
76	Task 7 Agreements	TideWater.WH2.B9	X	09/07/07	
77	Task 7 Agreements	V.Angoco Trucking	X	09/07/07	
78	Task 7 Agreements	CASAMAR			This was initially done between Casamar and GEDCA and may be under that name.
79	Background	CADD layout map of the entire port	N		Seems like CAD drawings not available, PB Taiwan to formulate
80	Background	Property line drawing showing leaseholds and expansion areas	N		No drawing received, Bob Hrdlicka to discuss with Dot Harris and update on PB CAD.
81	Background	Navigation map of channel and turning basin including navigation aids	N		None received, Ralph to followup and get from Coast Guard
82	Background	Identify changes in marine property transfer plans since 1999 master plan			
83	Background	Detailed CADD drawings of facilities and terminals	N		CAD Drawings not available, use scanned images.
84	Background	Information on access and transportation corridors, utilities and adjacent land for expansion			Check with Nelson on whether we have the data we need.
85	Task 6.1 Examine Infrastructure	Feasibility or preliminary engineering reports or descriptions of facilities	N		Not Received, assumed to be not available.

Table A1.3-1 List of Collected Data (Continued)

	Port Facility or Report Topic	Information	Status		Comments
			Rec:	Date	
86	Background	Marketing, financial or operations reports for the commercial port	N		Not Received, assumed to be not available.
87	Background	Environmental information and reports related to port and surrounding properties	X	09/07/07	Kilo Wharf EIS and Deep water wharf EIS are available.
88	Task 6.1 Examine Infrastructure	Report on Guam Port First Increment (Year 1966);			
89	Task 6.1 Examine Infrastructure	Report on Guam Port Second Increment (year 1967);			
90	Task 6.1 Examine Infrastructure	Report on Guam Port Third Increment (Year 1968);			
91	Task 6.1 Examine Infrastructure	Report on Berth F3 to F6 Earthquake repair (Year 1998);	X	09/07/07	Contained in PAG Drawings for Liftech
92	Task 6.1 Examine Infrastructure	Report on Observation Report existing Berth (Around Year 2005)			
93	Task 6.1 Examine Infrastructure	Report on Past two (2) year maintenance log (e.g. Works order);			
94	Task 6.1 Examine Infrastructure	Report on Survey Report' video of F5;			
95	Task 6.1 Examine Infrastructure	Report on Repair Report of F1;			
96	Task 6.1 Examine Infrastructure	Report on Rail Repair information.			
97	Background	Industry Trends & Forecasts for tourism			
98	Background	Summary of policies regarding historic preservation			
99	Background	Labor contract information	N		None received, base on interviews.
100	Background	Download of operating statistical database	X	09/07/07	PBUS to receive from Vince
101	Background	PAG Harbor Rules & Regulations from PAG website	X	09/07/07	Downloaded from PAG website
102	Task 9.1 Equipment	Container Yard and handling Equipment Meeting Info	X	09/07/07	
103	Task 2 Port user groups	Weekly report from budget department of employee utilization	X	09/07/07	Weekly Reports.pdf
104	Background	PAG Objectives & projects	X	09/07/07	
105	Task 8 Facility Utilization	Monthly board report on Container Comparison	X	09/07/07	Contains container counts and service times for Matson and Horizon vessels

Table A1.3-1 List of Collected Data (Continued)

	Port Facility or Report Topic	Information	Status		Comments
			Rec:	Date	
106	Task 8 Facility Utilization	Crane Performance 3rd quarter report	X	09/07/07	Crane Utilization for 3rd quarter FY 07 for the port
107	Task 2 Port user groups	Vessel particulars for Horizon Vessels	X	09/07/07	Contains vessel sizes for horizon ships, named vessel particulars.pdf
108	Task 8 Facility Utilization	Yard Capacity	X	09/07/07	
109	Background	Port Authority - Material handling & Storage Strategies	X	09/07/07	
110	Task 8 Facility Utilization	Daily MTs Receival	X	09/07/07	Contains count and source for Mts received in the week of 6/10/2007
111	Background	Bodallo Press Release	X	09/07/07	Contains article on Armed Forces Bill authorizing \$244 million construction in Guam
112	Task 8 Facility Utilization	Weekly Crane performance	X	09/07/07	Weekly Crane performance for week of 22-28 July 2007
113	Task 8 Facility Utilization	Monthly Container Out turn report	X	09/07/07	Contains statistics for July 2007
114	Background	Ports & Customs Subcommittee report	X	09/07/07	
115	Background	Info on Coral Reef adjacent to future F-7			
116	Background	GIS Info from Coast Zone Management	X	09/07/07	PBUS to receive from Vince
117	Industry Forum	Guam Deptt. Of Labor Presentation Aug 23-24	X	09/07/07	
118	Industry Forum	Guam Industry Forum Agenda Aug 23-24	X	09/07/07	
119	Industry Forum	Inter Agency Forum Aug2, 2007	X	09/07/07	
120	Industry Forum	PAG-GIAA Industry Forum	X	09/07/07	
121	Task 12.1 Marinas	Hagatna Marina Info	X	09/07/07	
122	Task 12.1 Marinas	Marina Developments - PAG Presentation	X	09/07/07	
123	Background	Appendix F (Costs) & building/structure description from Comprehensive Hazards, Vulnerabilities, Risks Assessment	X	01/23/08	Partial material with estimates and descriptions of detail building structural inspections performed with last five years (date not on material)
124	Task 9.1 Equipment	Crane Inspection Report, PACECO Portainer Crane S/N 852.	X	01/23/08	
125	Background	Public Law 28-92 describing recycling land needs to be provided by PAG	X	01/23/08	

Note: "X" indicates that material was received.

Appendix 2-1 Facility Assessment Methodology & Limitations

A2-1.1 METHODOLOGY

The Consultant performed the facilities data collection and assessment according to the methodology described below.

A2-1.11 Kick-off & As-built facility Reorganization

- ◆ Arrange kick-off meeting with Port authority of Guam on 06 August 2007, to confirm the inventory list. At the kick-off meeting, discuss known information about the facilities or components of as-built.
- ◆ Work procedures for PB survey team (Surveyor) were defined right after the kick-off. The team of Survey was established as:
 - Project Manager: Nira Ratnathicam
 - Team Lead: Nelson Wu
 - Port Facility (Structural) Engineer: Ibrahim Soudy
 - Port Facility (Civil) Engineer: L. C. Wang
 - Port Facility (MEP) Engineer: K. P. Leung
- ◆ Organize a one-day, Port-led orientation tour of the JDLGCP with the Surveyor, recognized the target facilities as listed below:
 - Berths, Piers, & Marinas
 - Berth F1
 - Berths F-2 through F-6
 - Rails on Berth F-4, F-5, & F-6
 - Other Piers (Hotel Wharf, Dog Leg Pier, Golf Pier, Family Beach)
 - Hagatna Marina, Agat Marina, & Aqua world Marina/Harbor of Refuge
 - Buildings & Structures
 - Port Administration Building
 - Horizon Lines d Offices
 - Container Freight Station
 - Equipment Maintenance & Repair Building
 - Warehouses 1 & 2
 - Welding Shed
 - Miscellaneous Structures (Port Police Station, Control Tower, Gas Station, Sewer Pump House, Oil Tank Farm)
 - Site Utilities
 - Electrical Service & Load Center
 - Storm Water Drainage System
 - Sanitary Sewer System
 - Domestic Water System
 - Yard Lighting
 - Fire Protection System
 - Other Building Services System
 - Facility Entrance
 - Container Yard Pavement
 - Gates & Fence
 - Access Roadway (Route #11)



- Equipment
 - Rail Mounted Gantry Crane (40 LT)
 - Mobile Harbor Crane (1040 ST)
 - Rubber Tire Gantry Crane (45 ST)
 - Other equipment (Top Lifter, Side Loaders, Heavy Lift Forklift, Tractor-Trailer, Forklift)

A2-1.12 On-Site Inspection/Survey

- ◆ The Surveyor performed a standard visual survey of the asset.
- ◆ The Surveyor documented the overall condition of the facilities for use in preparing the final assessment report.
- ◆ The Surveyor took a photograph of each target facility, if allowed by PAG escort; additional photographs may be required to adequately describe the details. The registered log of each target facility is attached at bottom of this section.
- ◆ The Surveyor documented the location of every deficiency (including asset-wide) found on a single line drawing drawn by the Surveyor indicating the approximate layout of the facility.
- ◆ The Surveyor notified the PAG escort or maintenance manager of any immediate safety deficiencies or dangerous situations found while surveying the facility and document the item.

A2-1.13 Interview & Data Collecting

- ◆ Interviews were conducted with Maintenance department of PAG (Port Authority of Guam), GPA (Guam Power Authority), GWA (Guam Water Authority) and GPW (Guam, Department of Public Works); observations were made by Surveyor during their survey of the existing Port area on 6 to 11 August 2007.
- ◆ This information is established based on following as-built information provided by PAG, GPA, and GWA:
 - Drawings for Guam Port first Increment (year 1966). (PAG, Record Drawing June 1970)
 - Drawings for Guam Port Second Increment (year 1967). (PAG, Record Drawing May 1970)
 - Drawings for Guam Port Third Increment (year 1968). (PAG, Record Drawing May 1970)
 - PAG Drawings for Container yard Expansion projects (year 1990).
 - PAG Drawings for Container yard Expansion projects Phase-II (year 1998). (PAG, Bid Set July 1998).
 - PAG Drawings for Electrical Sub-Station upgrade project (year 2003).
 - PAG Drawings for Berth F3 to F6 Earthquake Repairs (year 1996).
 - Details from GPA - single line diagram to illustrate the connection arrangement on the distribution side for the feeder feeding the port.
 - Details from GPW - single line diagram to illustrate the connection arrangement of the water pipe feeding the port.

The existing facilities, including domestic water supply, fire hydrants, site drainage, sewerage, manholes, yard lighting poles, mounted crane tracks, gates, fence, and its location associated with buildings and berths is presented as attached map. Site photos are also collected during the site visit dated 06 to 11 August 2007.



A2-1.14 Review data

- ◆ Review and assessment of all available literature, plans, land-use data, documents, and reports during the scheduled working period (Week 2 to 7).
- ◆ Request further information, when needed, from PAG through project communication channel.

A2-1.15 Assessment Report Assembly

- ◆ Surveyors documented their field observations of the overall condition of the facility in the following parts:
 - Description & Metrics
 - Condition Survey
 - Recommendations for Maintenance and Operational Improvement
 - Appendixes
- ◆ The Surveyors wrote standard overall descriptions and recommendations of the asset and for the architectural, structural, mechanical, electrical, and civil systems.

Site Photos were collected during the site visit dated 06 to 10 August 2007, and been categorized by facility I.D. listed as below.

Table A2-1.15-A Photography Registered Log

Facility I.D.	Facility/Building Title
01	Berth F-1
02	Berth F-2
03	Berth F-3
04A	Berth F-4
04B	Berth F-5
04C	Berth F-6
04D	Crane Track
05A	Port Administration Building
05B	Horizon Lines Building
06A	Container Freight Station
06B	Equipment Maintenance & Repair Building
07A	Warehouse 1
07B	Warehouse 2
08	Container Yard
09A	Welding Shed
09B	Miscellaneous Structures
10	Oil Tank Farm
11	Port Marinas
12	Load Center
13	Site Utilities
99	Others



A2-1.2 LIMITATIONS

- ◆ The private tenant controls facility access for most of Berths F-1 & F-2. Surveyor was unable to reach most of the interior area. Facility as-built drawings, documents, and other materials related to the facility and its associated systems were limited to availability. There is no historical reference material that can be provided and reviewed prior to the site survey stage.
- ◆ The on-site surveys were conducted building-by-building, with visual, non-invasive, and non-destructive inspections of the facility and its associated systems.
- ◆ The on-site surveys were not to place Surveyors into any hazardous situations such as confined spaces or contaminated areas.
- ◆ No physical measurement was performed during the survey; all dimensions & measures addressed in this report are referring to provided as-built documents, and shall be verified by topographic survey.
- ◆ No cost estimate for repair, retrofit, or enhancement was conducted.



Appendix 2-2 Select Building Drawings

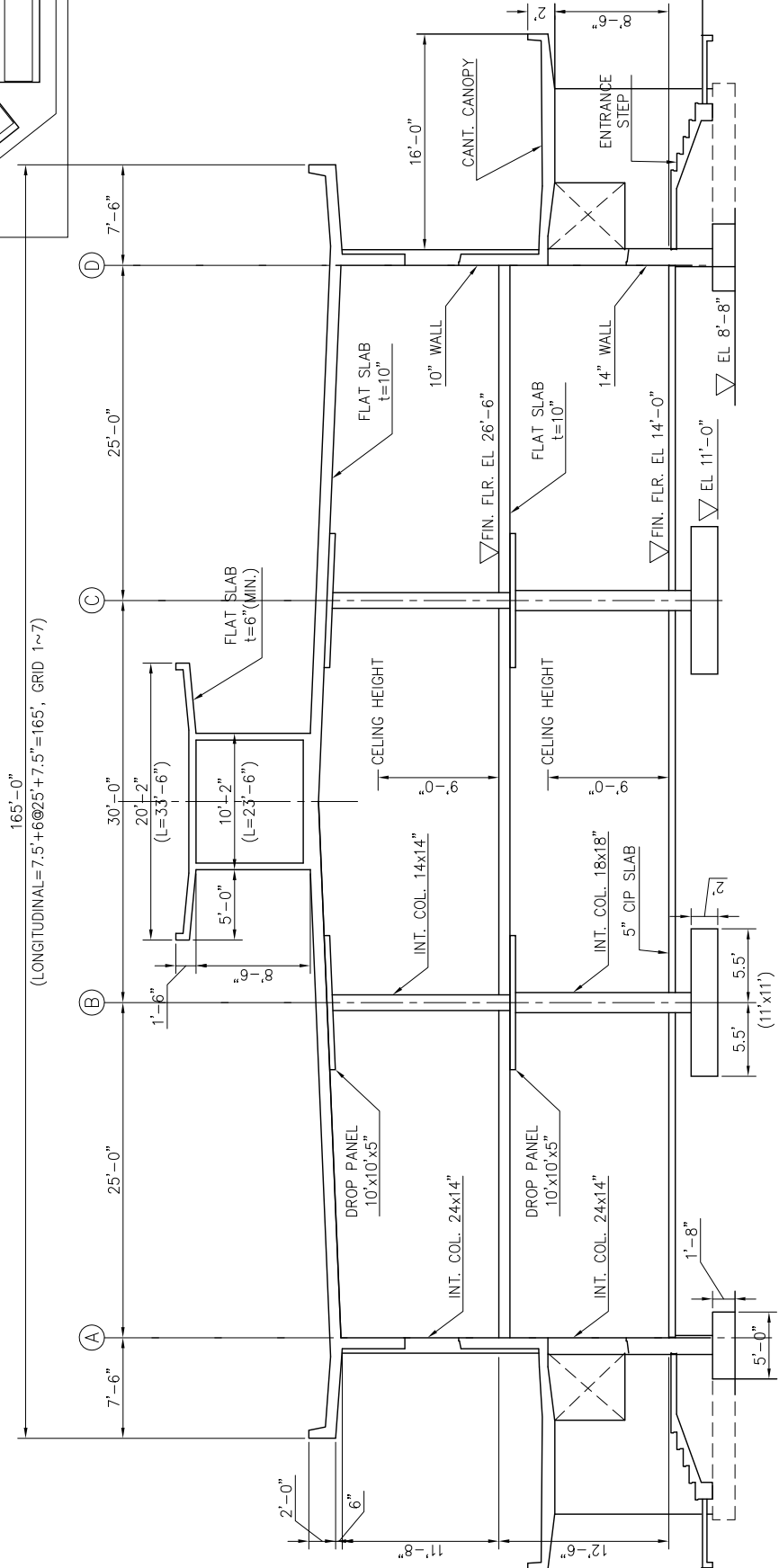

TRANSVERSE SECTION (E - W SECTION)

FIGURE NO.

PROJECT NAME
GUAM COMMERCIAL PORT MASTER PLAN UPDATE

SHEET TITLE

PORT ADMINISTRATION BUILDING
TYPICAL STRUCTURAL SECTIONS

D-05A

CONSULTANT



JOSE D. LEON GURRERO
COMMERCIAL PORT OF GUAM



NOTE: DIMENSIONS REFERRED TO AS-BUILT RECORDS, TO BE VERIFIED ON SITE.

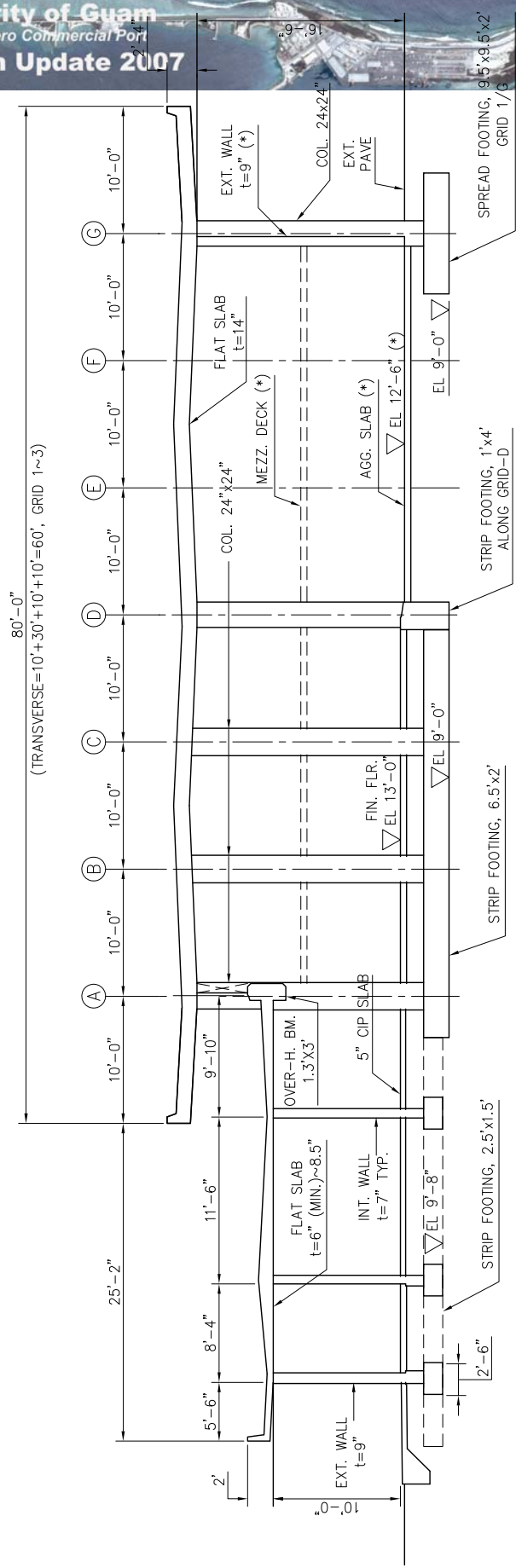
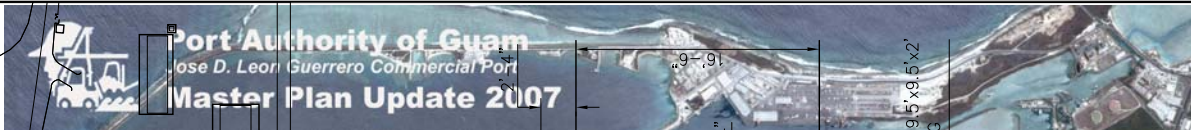

NOTE: (*) LIKELY CHANGED/ADDED BY EXPANSION

LONGITUDINAL SECTION (E - W SECTION, GRID 1)

NOTE: DIMENSIONS REFERRED TO AS-BUILT RECORDS, TO BE VERIFIED ON SITE.

<p>PROJECT NAME GUAM COMMERCIAL PORT MASTER PLAN UPDATE</p> <p>FACILITY TITLE SEALAND OFFICES TYPICAL STRUCTURAL SECTIONS</p>	<p>CONSULTANT PB 100 YEARS</p>	<p>FIGURE NO. D-05B</p>
--	---	------------------------------------

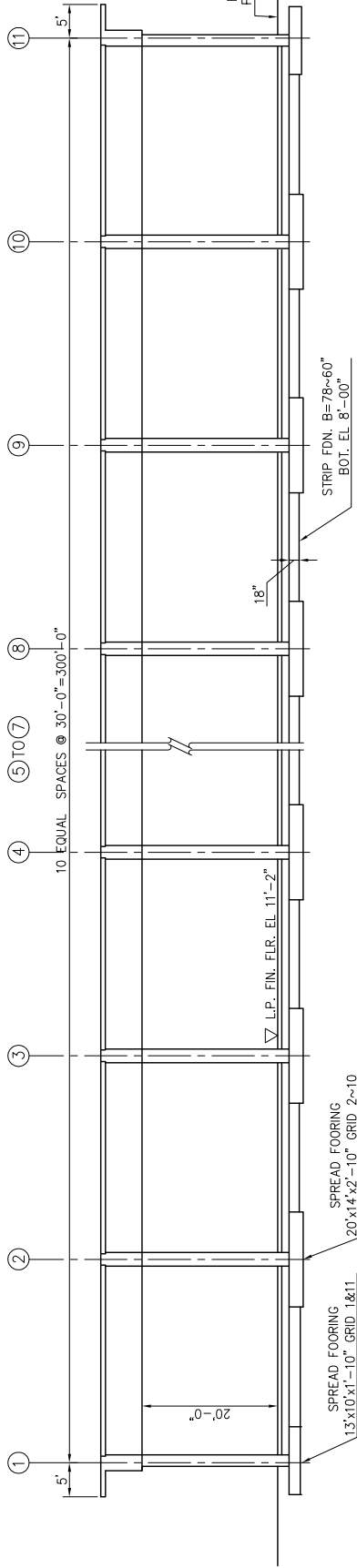

LONGITUDINAL SECTION (N - S SECTION, GRID A & C)

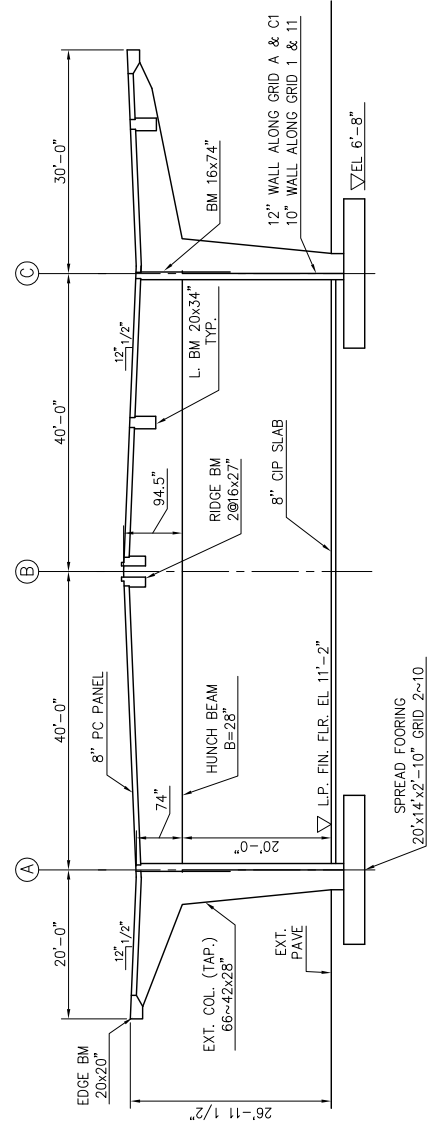

TRANSVERSE SECTION (E - W SECTION, GRID 2-10)

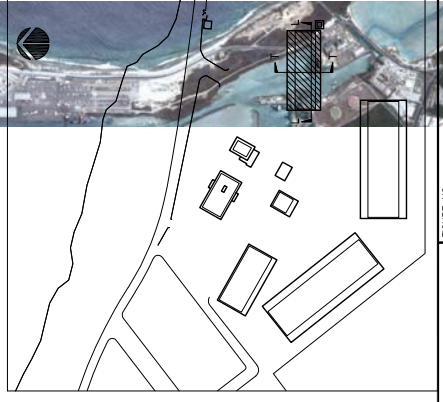

FIGURE NO.

D-06A

PROJECT NAME
GUAM COMMERCIAL PORT MASTER PLAN UPDATE

FIGURE TITLE
CONTAINER FREIGHT STATION
TYPICAL STRUCTURAL SECTIONS

CONSULTANT



JOSE D. LEON GURRERO
COMMERCIAL PORT OF GUAM

NOTE: DIMENSIONS REFERRED TO AS-BUILT RECORDS, TO BE VERIFIED ON SITE.

April 2008

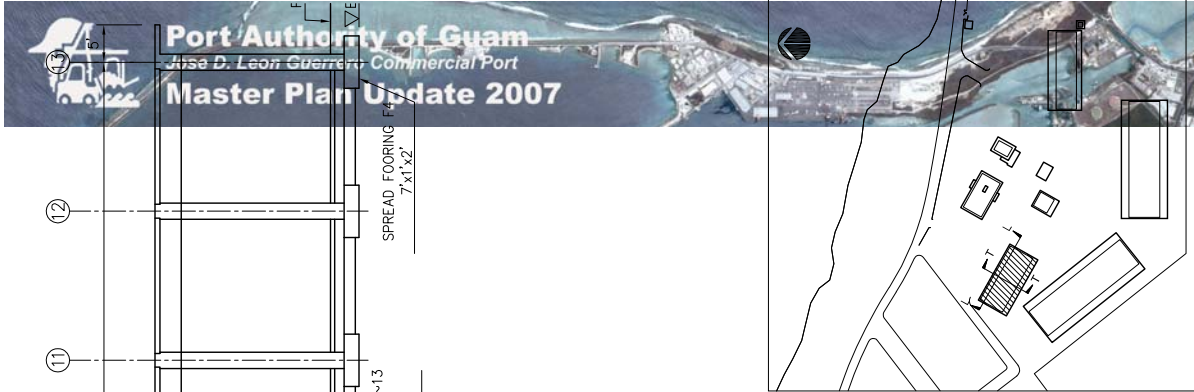
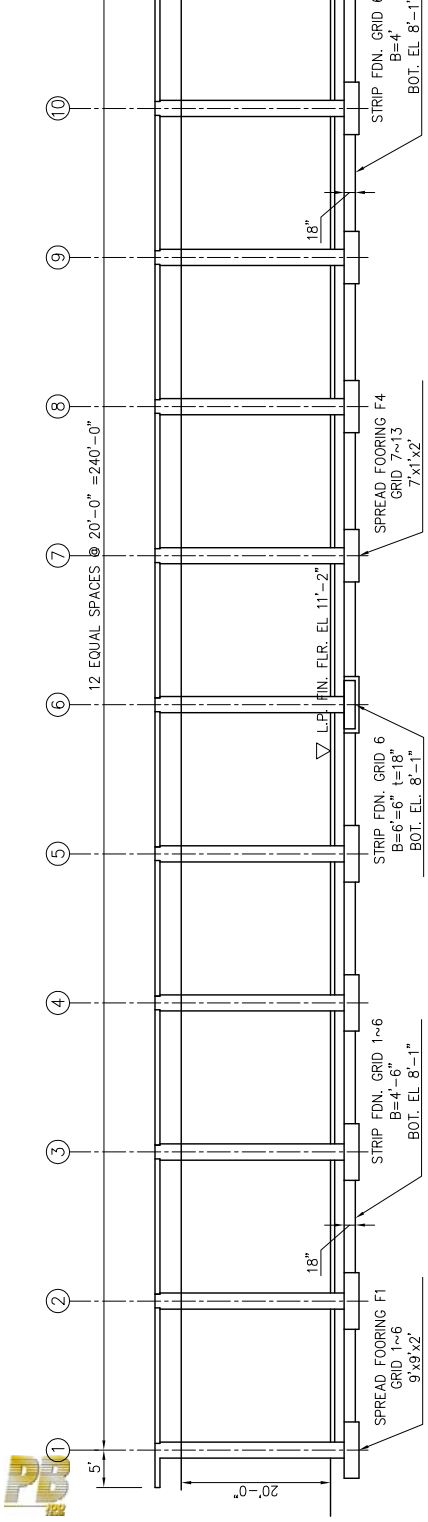
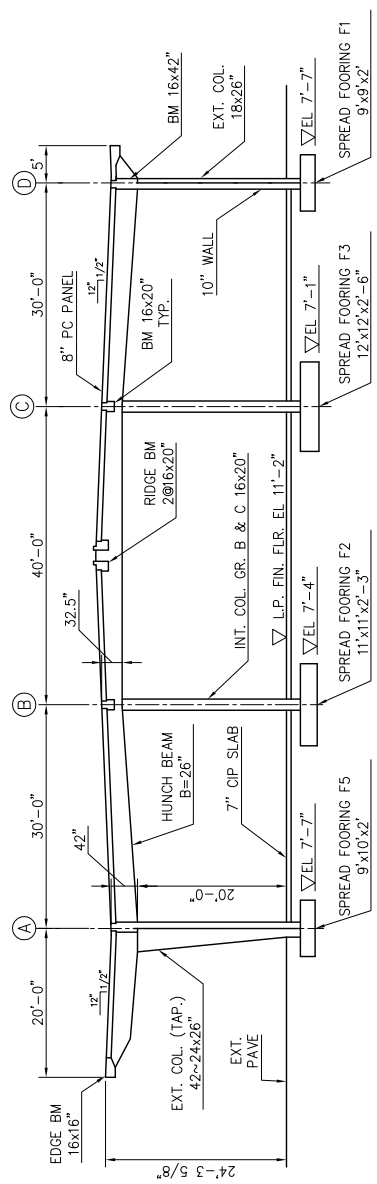

FIGURE NO. **D-06B**



LONGITUDINAL SECTION (N - S SECTION, GRID D)



TRANSVERSE SECTION (E - W SECTION, GRID 2)

CARRIER'S MAINTENANCE & REPAIR BUILDING
 TYPICAL STRUCTURAL SECTIONS

PROJECT NAME: GUAM COMMERCIAL PORT MASTER PLAN UPDATE

FIGURE TITLE

CONSULTANT



JOSE D. LEON GURRERO
 COMMERCIAL PORT OF GUAM

NOTE: DIMENSIONS REFERRED TO AS-BUILT RECORDS, TO BE VERIFIED ON SITE.

April 2008

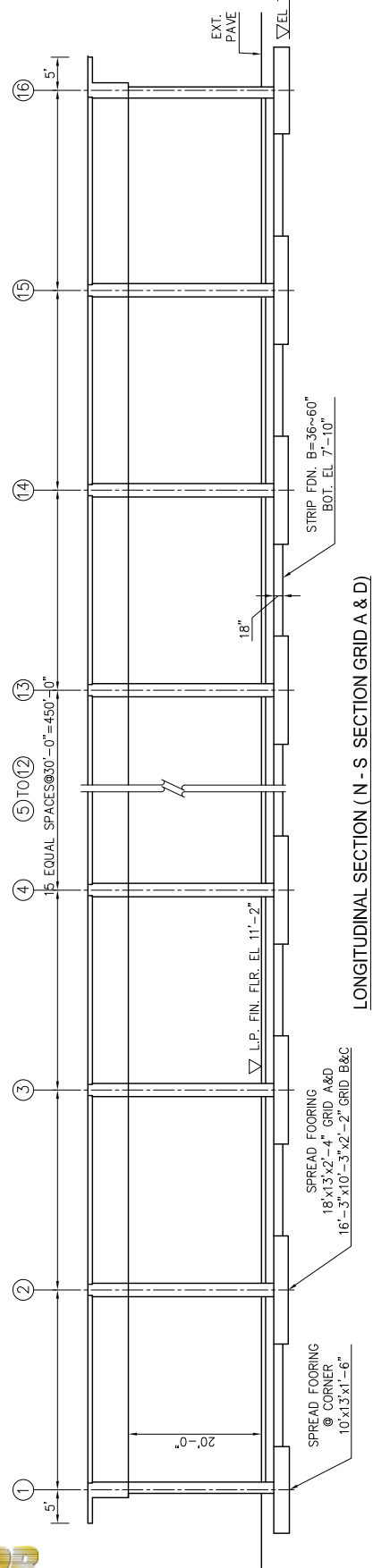

LONGITUDINAL SECTION (N-S SECTION GRID A & D)

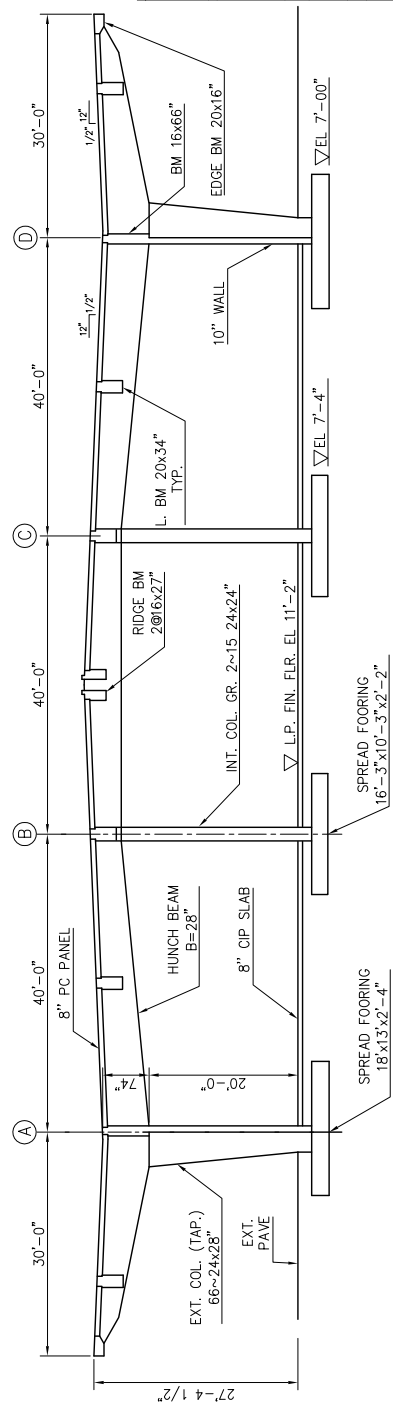

TRANSVERSE SECTION (E-W SECTION, GRID 2-15)

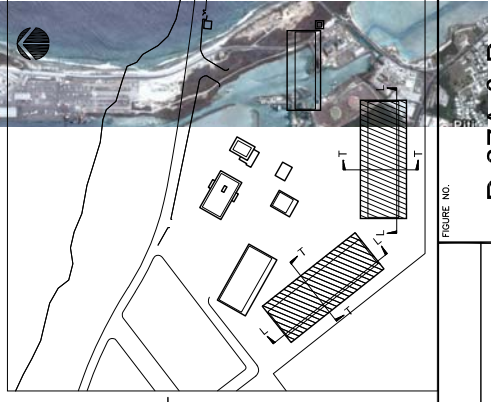

FIGURE NO.

D-07A & B

PROJECT NAME
 GUAM COMMERCIAL PORT MASTER PLAN UPDATE

FACILITY TITLE

TRANSIT SHED #1 & #2
 TYPICAL STRUCTURAL SECTIONS

CONSULTANT



JOSE D. LEON GURRERO
 COMMERCIAL PORT OF GUAM

NOTE: DIMENSIONS REFERRED TO AS-BUILT RECORDS,
 TO BE VERIFIED ON SITE.



FIGURE NO.

D-09B-(1)

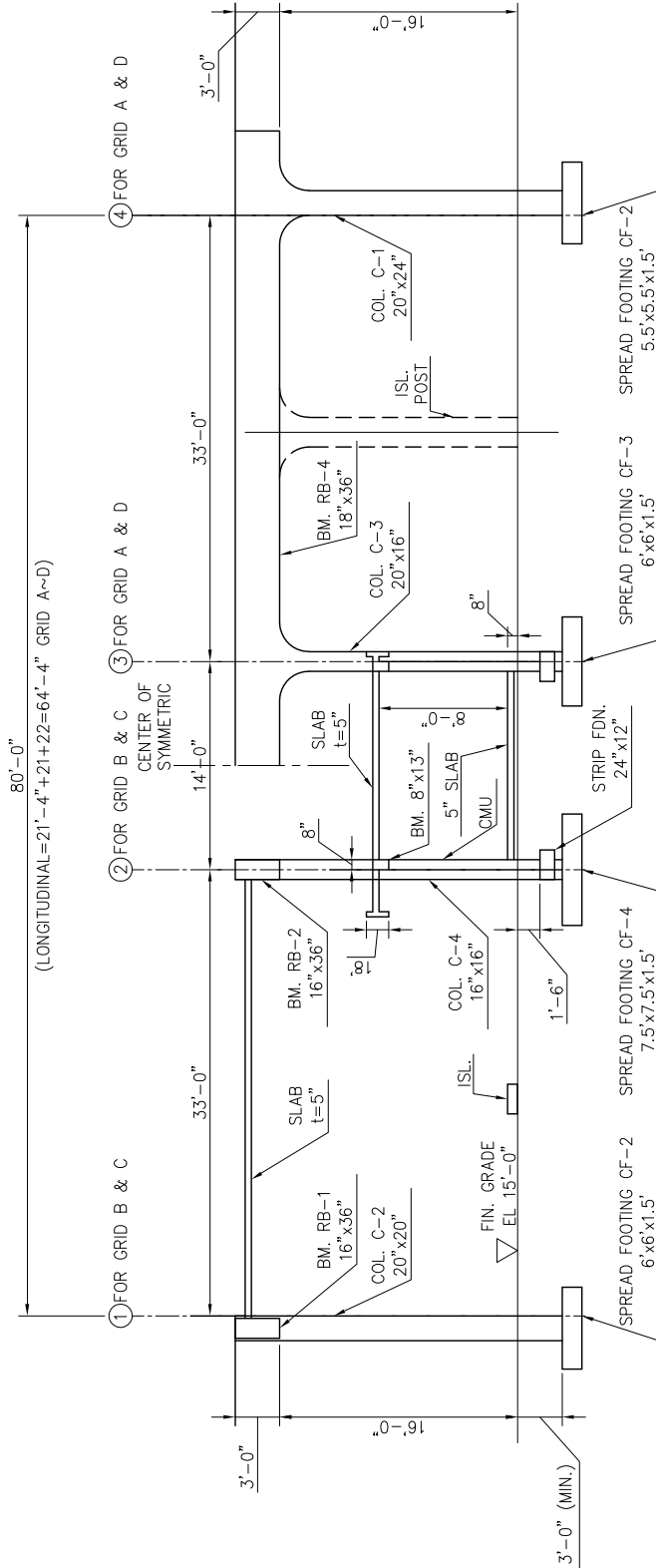

TRANSVERSE SECTION (N-S SECTION, GRID B & C)

NOTE: DIMENSIONS REFERRED TO AS-BUILT RECORDS,
 TO BE VERIFIED ON SITE.

PROJECT NAME
 GUAM COMMERCIAL PORT MASTER PLAN UPDATE
 DRAWING TITLE
YARD ENTRANCE GATE
 TYPICAL STRUCTURAL SECTIONS



CONSULTANT

JOSE D. LEON GURRERO
 COMMERCIAL PORT OF GUAM



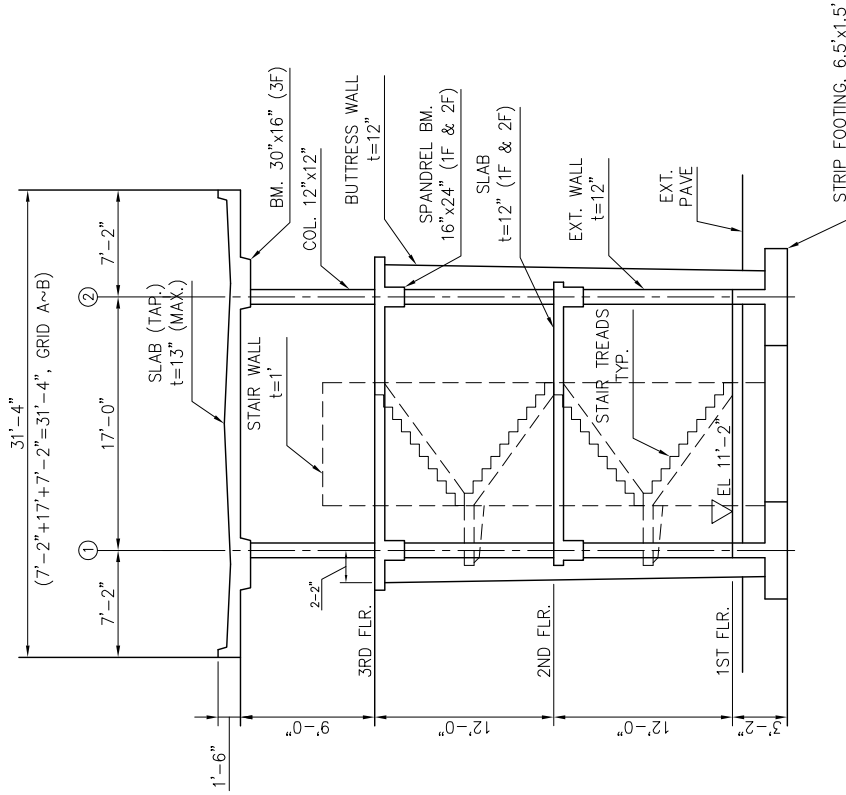

TRANSVERSE SECTION (N-S SECTION)

NOTE: DIMENSIONS REFERRED TO AS-BUILT RECORDS, TO BE VERIFIED ON SITE.

CONSULTANT



JOSE D. LEON GURRERO
COMMERCIAL PORT OF GUAM

PROJECT NAME
 GUAM COMMERCIAL PORT MASTER PLAN UPDATE
 FACILITY TITLE
CONTROL TOWER
 TYPICAL STRUCTURAL SECTIONS

FIGURE NO.

D-09B-(2)



Appendix 2-3 Photographs

Photograph Gallery 01 - **"Berth F-1"**

Facility I.D. Berth F-1

Photo description: front view Berth F-1



Photo description: connection bridges between decks for F-1, to end of F-1



Facility I.D. Berth F-1

Photo description: steel pile for F-1 deck, retrofit to earthquake damage on top portion



Photo description: island of F-1



Photograph Gallery 02~04 - **"Berths F2 through F6"**

Facility I.D. Berth F-2

Photo description: distance view from seaside to Berth F-2, Casamar fish net repair/restoration



Photo description: Close view to F-2 dock side, concrete cover peeled off, rebar exposed.



Facility I.D. Berth F-3

Photo description: distance view from seaside to Berth F-3, supported by sheetpile wall (with tie-back) and concrete cap.



Photo description: concrete paved apron in front of Shed-1, ponding.



Facility I.D. Berth F-4

Photo description: distance view from seaside to Berth F-4 & Shed-2, berth supported by sheetpile wall (with tie-back) and concrete cap.



Photo description: concrete paved apron in front of Shed-2



Facility I.D. Berth F-5

Photo description: concrete paved apron in front of container yard, rebuilt dock (about 250 feet from the wharf face). Paceco Crane (50 feet rail gauge) in operation along F-5



Photo description: Close view on precast reinforced concrete pile (4 piles in a row)



Facility I.D. Berth F-5

Photo description: Interface between original section (F-4) and retrofit section (F-5)



Photo description: mounted rail & service pits for Paceco Crane (50 feet rail gauge)



Facility I.D. Berth F-6

Photo description: distance view from seaside to Berth F-6 & Crane (no in operation)



Photo description: Berth F-6 supported by sheetpile wall (with tie-back) and concrete cap. rebar exposed.



Facility I.D. Berth F-6

Photo description: Abandon Ship near F-6



Photo description: Coral head obstruction (near F-6, in front of future F-7)



Photograph Gallery 05A - **"Port Administration Building"**

Facility I.D. Port Admin. Bldg.

Photo description: Parking lot in front of Admin. Bldg.



Photo description: Attached RC Stair.



Facility I.D. Port Admin. Bldg.

Photo description: Side elevation. 2-floors RC frame structure



Photo description: Front elevation with entrance canopy



Photograph Gallery 05B - **"Horizon Lines"**

Facility I.D. Horizon Lines

Photo description: Front elevation. 2-floors RC frame structure, attached steel stair



Photo description: Lower roof section (south side, rear elevation)



Photograph Gallery 06A - "Container Freight Station"

Facility I.D. Container Freight Station

Photo description: typical span of reinforced concrete structure. Spread footing 1.0~1.5' depth



Photo description: Ditto.



Photograph Gallery 06B - "Equipment Maintenance & Repair Building"

Facility I.D. Equipment Maintenance & Repair Building

Photo description: Rear elevation



Photo description: Side elevation (far end)



Photograph Gallery 07A&B - **“Warehouse 1 & 2”**

Facility I.D. Warehouse 1 & 2
Photo description: W1. east span (view from rear side), LC2 attached



Photo description: W1. typical span of reinforced concrete structure.



Facility I.D. Warehouse 1 & 2

Photo description: W1. side elevation (view from Shed-2 side)



Photo description: W1. concrete paved apron between Shed-1 & Shed-2



Facility I.D. Warehouse 1 & 2

Photo description: W1. cantilevered span canopy



Photo description: W1. cantilevered span canopy, leakage.



Facility I.D. Warehouse 1 & 2

Photo description: W2. reinforced concrete structure, east span (view from rear)

side).



Photo description: W2. west span (view from rear side). Hazard storage (separated fence) behind.



Photograph Gallery 09A - **“Welding Shop Shed”**

Facility I.D. Welding Shop Shed

Photo description: side elevation, reinforced concrete structure



Photo description: Front elevation.



Photograph Gallery 09B - **"Miscellaneous Structures"**

Facility I.D. Miscellaneous Structures

Photo description: Port Police Station



Photo description: Load Center (LC #1)



Facility I.D. Miscellaneous Structures

Photo description: Load Center (LC #2)



Photo description: Load Center (LC #3)





Facility I.D. Miscellaneous Structures

Photo description: Load Center (LC #4, Roof)



Photo description: Control Tower



Facility I.D. Miscellaneous Structures

Photo description: Gas Station



Photo description: Sewerage Pump House



Photograph Gallery 10 - "Oil Tank Farm"

Facility I.D. Oil Tank Farm

Photo description: Shell Oil Tanks, with retaining wall (design to retain 130% of one tank volume)



Photo description: Oil Tank (far side)



Photograph Gallery 08 - **“Container Yard Pavement”**

Facility I.D. Container Yard Pavement

Photo description: Hyster (heavy lift forklift) at yard



Photo description: Tie-down anchor for container tie-down cable



Facility I.D. Container Yard Pavement

Photo description: containers stack 3 layers (ponding on limited area)



Photo description: rail mounted gantry cranes vs. trucks operated in yard



Facility I.D. Container Yard Pavement

Photo description: Chassis parking on yard (far side)



Photo description: rubber tire-mounted gantry on yard (Transtainer)



Facility I.D. Container Yard Pavement

Photo description: yard concrete paved apron and refrigerated containers



Photo description: parking stops in yard



Photograph Gallery 13A - "Gates & Fences"

Facility I.D. Gates & Fences

Photo description: yard entrance gate and control point



Photo description: chain-link fence gate



Facility I.D. Gates & Fences

Photo description: CMU boundary wall with one side outrigger with 3 strands barbed wire angled outward



Photo description: chain-link fence w/ vinyl coated fabric & posts. Attached traps for BTS.



Photograph Gallery 13B - "Access Roadway (Route #11)"

Facility I.D. Access Roadway (Route #11)

Photo description: Route-1 (near intersection Route 11)



Photo description: Route 11 typical section. 12-foot travel lanes with 10-foot wide shoulder. Large amount of rocks/coral rubble piled up in front of existing seawall.



Photograph Gallery 12 - "Load Centers"

Facility I.D. Load Center LC1

Photo description: Air cooled chiller near LC-1



Photo description: Generator set room and the associated oil tank for LC-1



Facility I.D. Load Center LC1

Photo description: Oil tank for LC-1



Photo description: Cable pipes outside LC-1



Facility I.D. Load Center LC1

Photo description: Switchgear and transformer in LC-1



Photo description: Outgoing HV cables from LC-1 to LC-2 and LC-3



Facility I.D. Load Center LC1

Photo description: Nameplate for transformer in LC-1



Photo description: Switchgear panels in LC-1



Facility I.D. Load Center LC1

Photo description: Nameplate for generator in LC-1



Photo description: NA

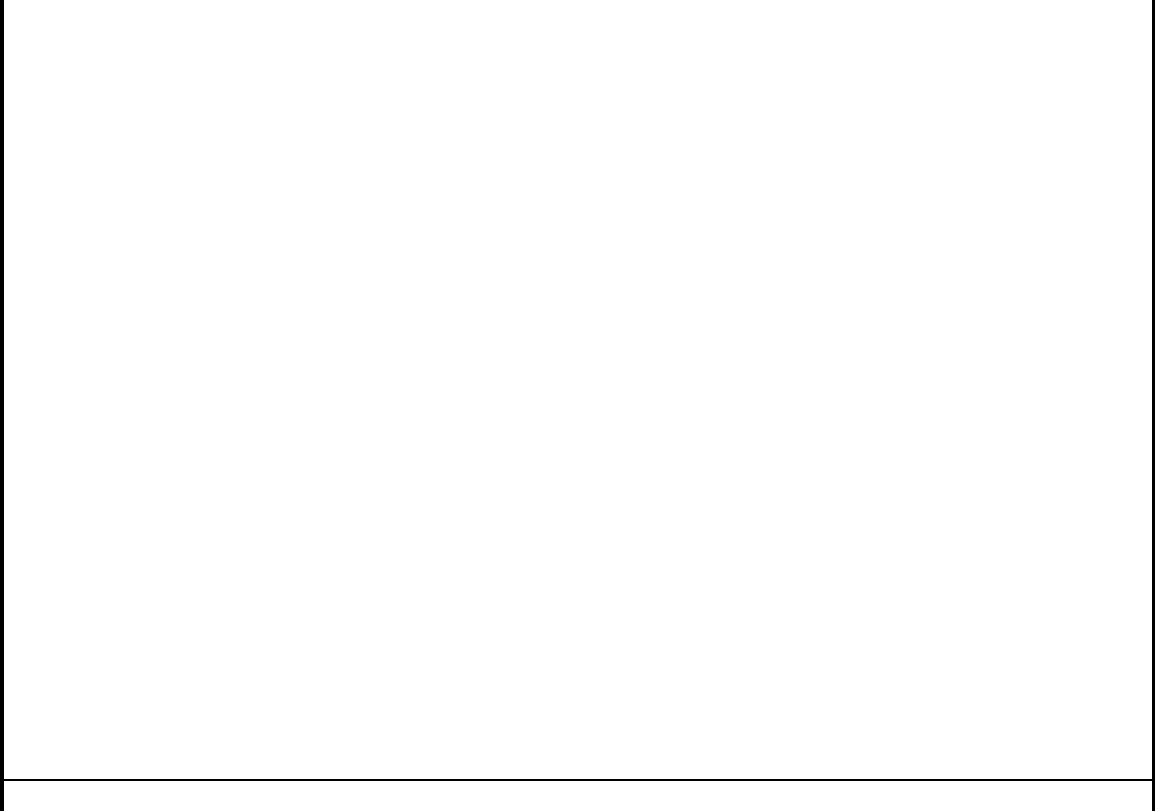

Facility I.D. Load Center LC2

Photo description: Distance view of LC-2



Photo description: Water cooled air marking machine next to Warehouse 2



Facility I.D. Load Center LC2

Photo description: Switchgear and transformer in LC-2



Photo description: Emergency generator and the set mounted oil tank in LC-2, not located inside the oil retaining wall





Facility I.D. Load Center LC2

Photo description: Nameplate for a small dry-type transformer in LC-2



Photo description: Nameplate for power transformer in LC-2



Facility I.D. Load Center LC2

Photo description: Inside view of power panel in LC-2



Photo description: Cable draw pit outside LC-2



Facility I.D. Load Center LC3

Photo description: Switchgear and transformer in LC-3



Photo description: Emergency generator in LC-3



Facility I.D. Load Center LC3

Photo description: Oil tank for generator in LC-3, not located inside the oil retaining wall



Photo description: Side view of the generator and associated oil tank in LC-3



Facility I.D. Load Center LC3

Photo description: Cathodic protection panel in LC-3



Photo description: Temperature dial for the power transformer in LC-3



Facility I.D. Load Center LC3

Photo description: Sump pit cover inside LC-3



Photo description: Cable trench and cable for cathodic protection connecting to outside



Facility I.D. Load Center LC4

Photo description: Stainless steel Switchgear and transformer in LC-4



Photo description: Emergency generator and associated oil tank in LC-4



Facility I.D. Load Center LC4

Photo description: Stainless steel Switchgear and transformer in LC-4



Photo description: Cable draw pit inside LC-4



Photograph Gallery 13 - "Site Utilities"

Facility I.D. Site Utilities

Photo description: Shore supply outlets near F-4, R to L, shore electrical receptacle connection, potable water and fire hydrant.



Photo description: A close up view of the shore electrical receptacle



Facility I.D. Site Utilities

Photo description: View from rear side of W1. Outdoor maintenance works and storage areas behind the shed.



Photo description: Reefer Socket Outlets, near north fence



Facility I.D. Site Utilities

Photo description: Close up view of reefer socket outlet



Photo description: Power panel supplying the reefer outlets



Facility I.D. Site Utilities

Photo description: Navigation Light near F-6



Photo description: Hazard storage (behind W2)



Facility I.D. **Site Utilities**

Photo description: Electrical cable manholes near abandon gas station



Photo description: Sewage manholes near abandon gas station



Facility I.D. **Site Utilities**

Photo description: Pole mounted yard lighting



Photo description: GPA lead in light pole



Facility I.D. Site Utilities

Photo description: Typical drain sump (near abandon gas station)



Photo description: Yard Drains – surface ditch & sump pit



Facility I.D. Site Utilities

Photo description: Site Drain outlet (direct toward sea without treatment)

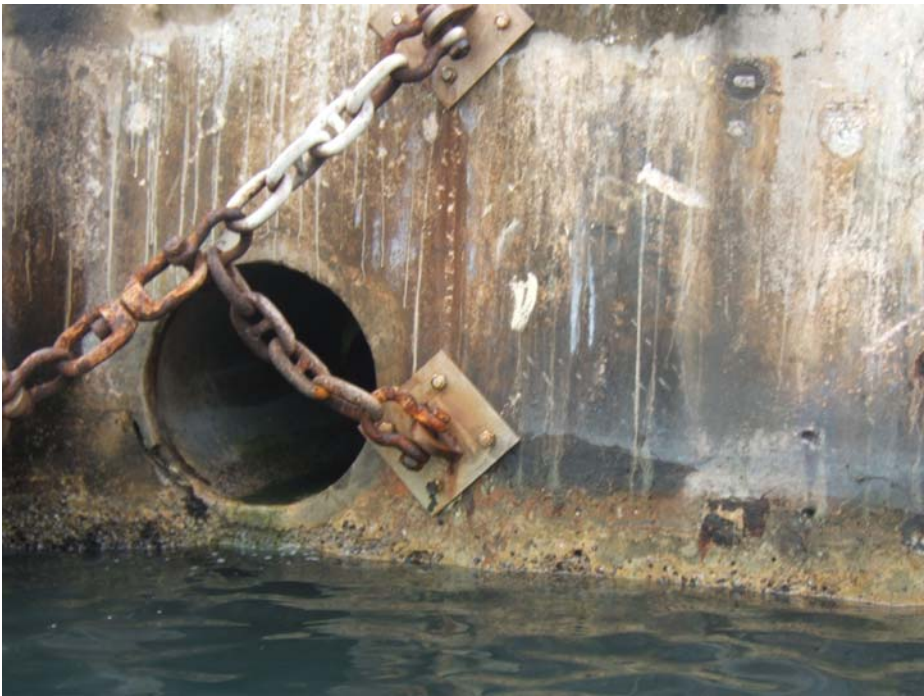

Photo description: NA

Facility I.D. Seaplane Ramp

Photo description: View from the water side in the front of Seaplane Ramp

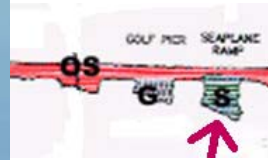
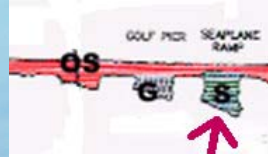

Photo description: A close up view from the water side in front of the Seaplane Ramp



Facility I.D. Seaplane Ramp

Photo description: View from the land side in the left end of Seaplane Ramp



Photo description: A close up view about the damage from the land side in the left side of the Seaplane Ramp



Facility I.D. Seaplane Ramp

Photo description: View from the water side in the right end of Seaplane Ramp



Photo description: A close up view from the land side of the Seaplane Ramp



Facility I.D. Seaplane Ramp

Photo description: View from the land side of Seaplane Ramp



Photo description: A close up view from the land side of the Seaplane Ramp





Facility I.D. **Seaplane Ramp**
Photo description: View from the land side of Seaplane Ramp



Photo description: A close up view from the land side of the Seaplane Ramp



Facility I.D. Seaplane Ramp

Photo description: A close up view from the water side in the left side of the Seaplane Ramp



Facility I.D. Seaplane Ramp

Photo description: View from the land side of Seaplane Ramp



Photo description: A close up view from the land side of the Seaplane Ramp



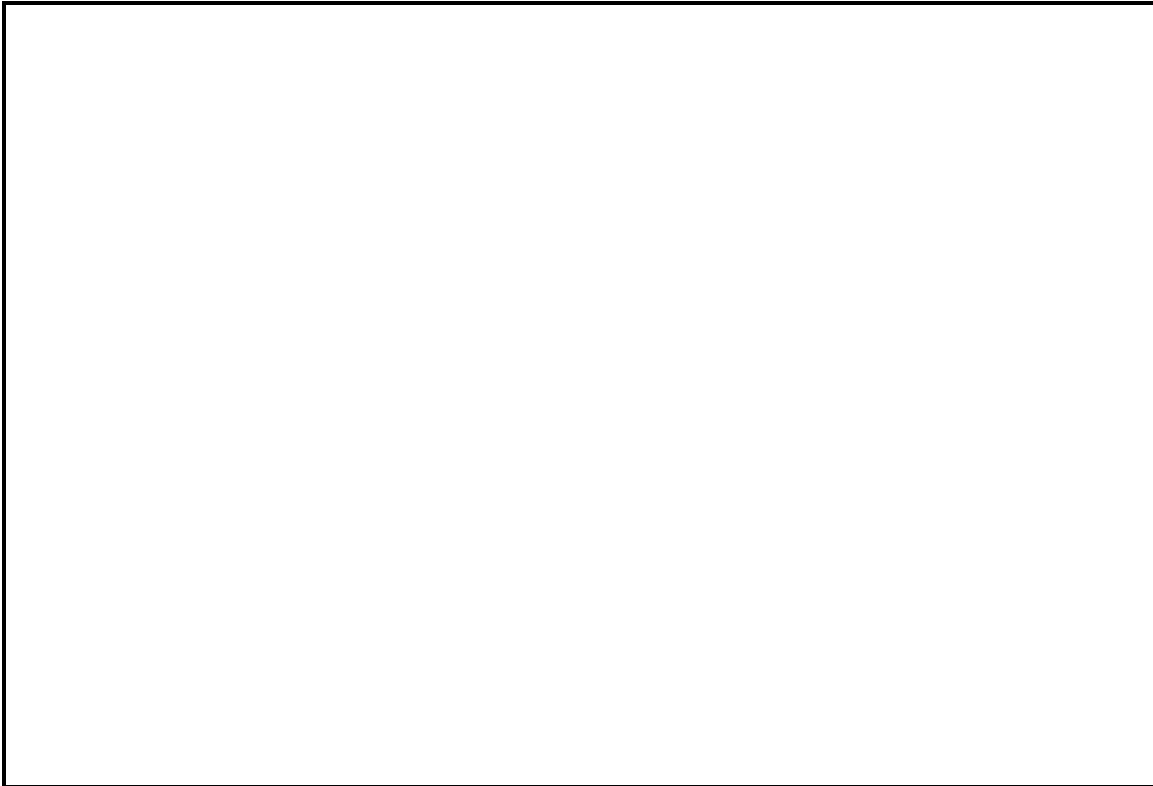

Facility I.D. **Golf Pier**

Photo description: **View from the water side of Golf Pier**



Photo description: **A close up view from the water side of the Seaplane Ramp**



Facility I.D. Golf Pier
Photo description: Close up view of Pier Structure from the water side of Golf Pier



Photo description: Close up view of Pier Structure from the water side of Golf Pier



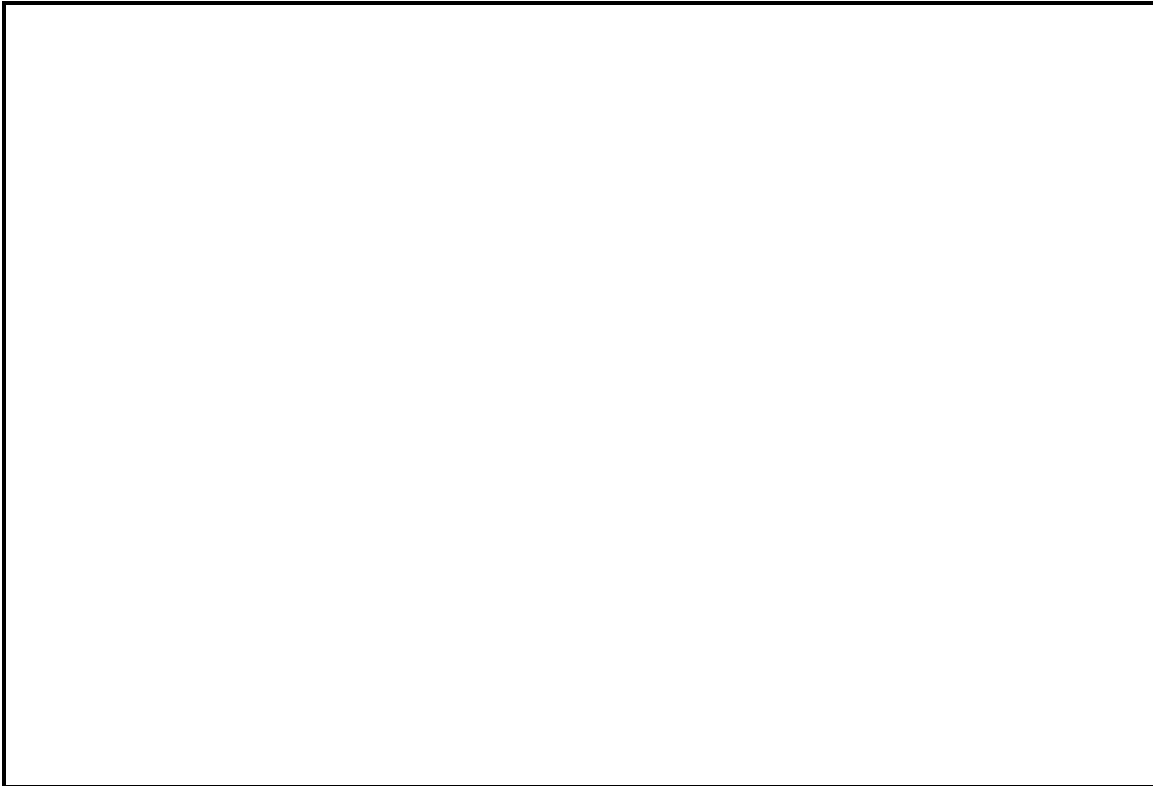

Facility I.D. **Golf Pier**

Photo description: Close up view of Pier Structure from the water side of Golf Pier



Photo description: Close up view of Pier Structure from the water side of Golf Pier



Facility I.D. Golf Pier

Photo description: Close up view of Pier Structure from the water side of Golf Pier



Photo description: Close up view of Pier Structure from the water side of Golf Pier





Facility I.D. **Golf Pier**

Photo description: **Close up view of Pier Structure from the water side of Golf Pier**



Photo description: **Close up view of Pier Structure from the water side of Golf Pier**



Facility I.D. Golf Pier
Photo description: Close up view of Pier Structure from the water side of Golf Pier



Photo description: Close up view of Residual Pier Structure from the water side of Golf Pier

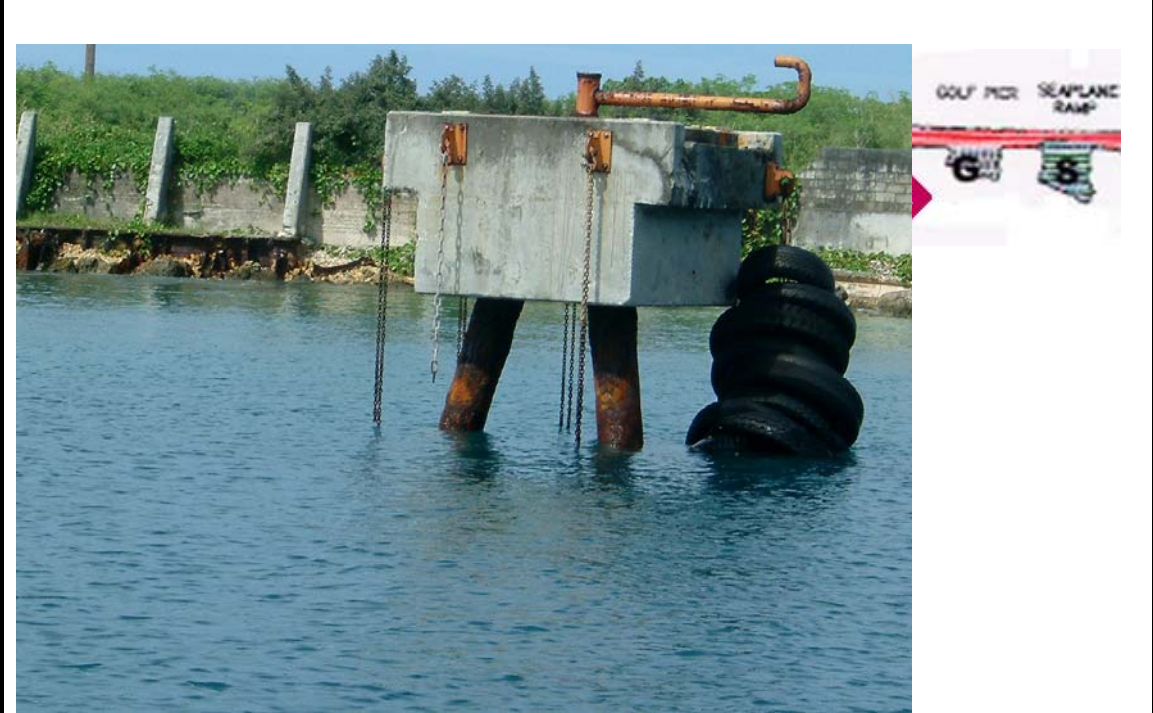

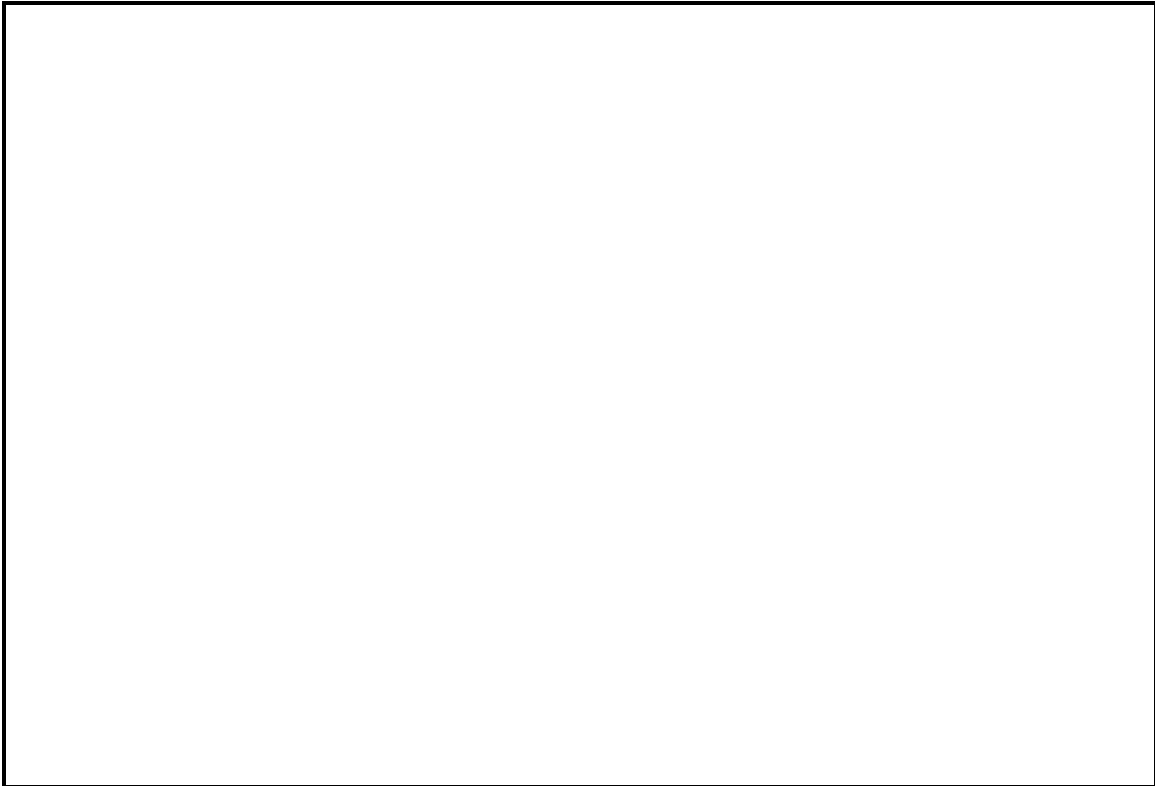

Facility I.D. **Hotel Wharf**
Photo description: Close up view of Hotel Wharf from the water side. Note the damage in the photo



Photo description: Close up view from the water side of Hotel Wharf



Facility I.D.

Hotel Wharf

Photo description: Close up view of Hotel Wharf from the water side.



Photo description: Close up view from the water side of Hotel Wharf



Facility I.D. Hotel Wharf

Photo description: Close up view of Hotel Wharf from the water side.



Photo description: Close up view from the water side of Hotel Wharf



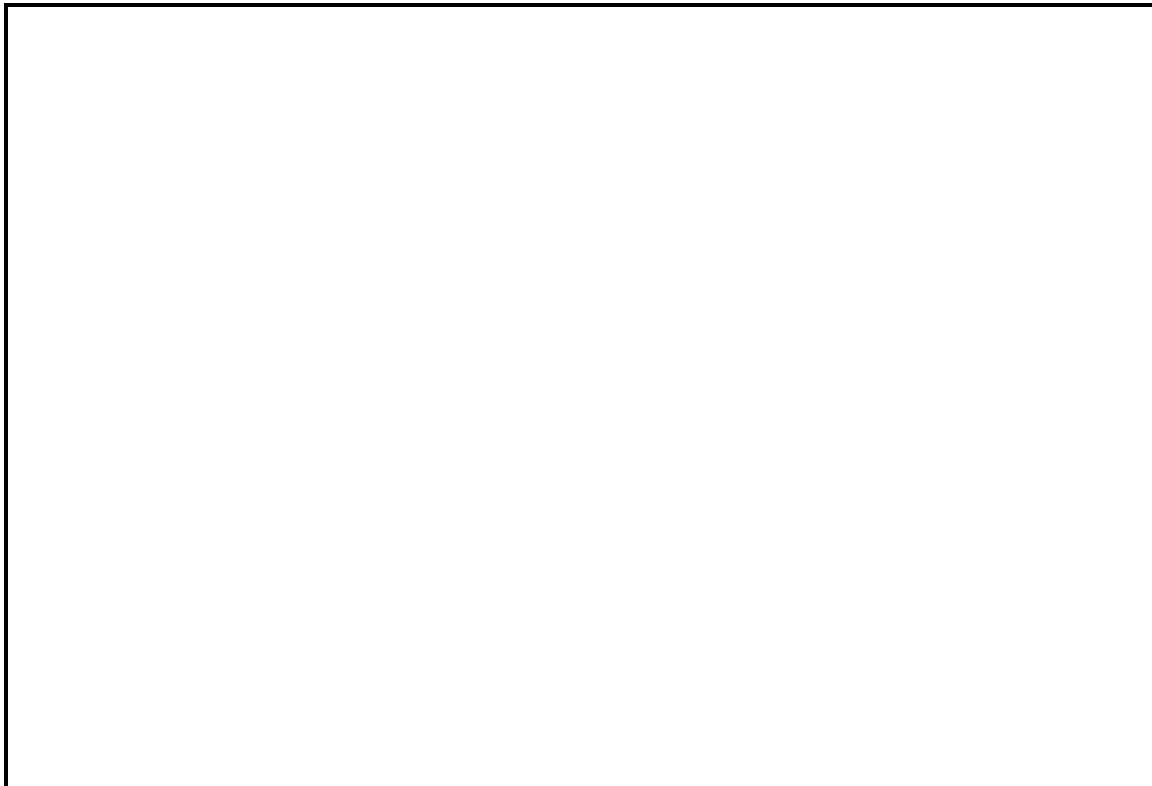

Facility I.D.

Hotel Wharf

Photo description: Close up view of Hotel Wharf from the water side. Note the damage in the photo



Photo description: Close up view from the water side of Hotel Wharf. Note the damage in the photo.



Facility I.D. Hotel Wharf

Photo description: Close up view of Hotel Wharf from the land side.



Photo description: Close up view from the land side of Hotel Wharf





Facility I.D.

Hotel Wharf

Photo description: Close up view of Hotel Wharf from the land side. Note the damages in these photos



Photo description: Close up view from the land side of Hotel Wharf. Note the damage on the foundation of bollard in the photo



Facility I.D. Hotel Wharf

Photo description: Close up view of Hotel Wharf from the land side.



Photo description: Close up view from the land side of Hotel Wharf



Facility I.D.

Hotel Wharf

Photo description: Close up view of Hotel Wharf from the land side. Note the damage in the photo

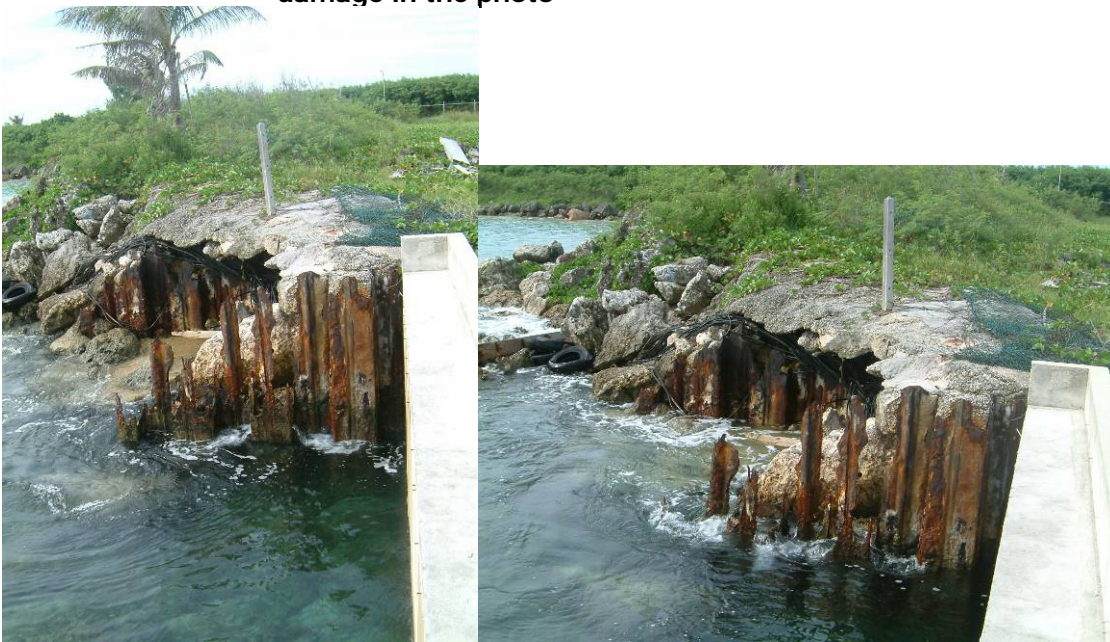

Photo description: Close up view from the land side of Hotel Wharf. Note the corrosion and the leaks on the domestic water piping in these photos



Facility I.D. Pier Dog and Family Beach
Photo description: Close up view from the water side.



Facility I.D. Pier Dog and Family Beach

Photo description: Close up view from the water side. Note that there are still many residual waterfront structures which are hazardous to water recreational activities



Photo description: Close up view from the water side. Note that there are still many residual waterfront structures which are hazardous to water recreational activities

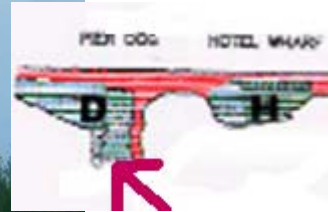

Facility I.D. Pier Dog and Family Beach

Photo description: Close up view from the water side of Family beach.



Photo description: Close up view from the water side of Family beach.



Facility I.D. Pier Dog and Family Beach

Photo description: Close up view from the water side of Family beach.





Appendix 3-1 Tabulation of Lease Agreements

The following is a tabulation of certain detailed information provided to the consultant by PAG. For a description of key findings and an additional descriptive summary of major lease agreements, please refer to "Section 3 - Current Lease Agreements".



Table A3-1.1 Key Index for Tabulation of Lease Agreements

Location Index Acronym	Defined
A	Admin
AA	Admin Annex
ASBM	Agat Small Boat Marina
CFS	Container Freight Station
CL	Chassis Lot
GEDA	Cabras Industrial Park
HOR	Harbor of Refuge
HW	Hotel Wharf
Rt 11	Adjacent to Rt 11 Strip
Seaplane	Seaplane Ramp
Tank Farm	Area A
U/E	Under Warehouse Eaves
W1	Warehouse 1
W2	Warehouse 2

Prevailing Fees		
Office	Warehouse	Open
1.37	0.53	0.37

Associated Info	Applicable Fee
Common Area	N/A
Trash Fee	N/A
Power	Consumption Dependent
Telephone	Service Dependent

NOTE(S):

1. All PAG negotiated (as opposed to GEDCA) leases are month-to-month basis. As such renewal provision not applicable.
2. Lease Year - First digits of assigned account code (ie. 2004 - 001; Year 2004, first lease of the year).
3. GEDCA Tract leases were long term development leases negotiated by GEDA and subsequently assigned to PAG in 1988 with periodic escalation every option year.
4. Petroleum related throughput-royalty revenues not reflected in this report.

Source: Port Authority of Guam

Table A3-1.2 Tabulation of Lease Agreements

Tenant	Location	Lease No.	Start Date	Warehouse	Office	Open	Purpose/Comment
Ambyth Shipping & Trading	A205	95-024	12/13/1995		1204		Agent
Ambyth Shipping & Trading	A222	95-024	12/13/1995		502		Agent
Ambyth Shipping & Trading	A219	95-024	12/13/1995		216		Agent
Ambyth Shipping & Trading	CL	ST2002-005	10/1/2002			1000	Agent
American Bureau of Shipping	A223	99-013	1/1/1999		192		Agent
Aqua World	HOR	85-001	1/1/1985				Marina Management/Under Legal Review
Aqua World	HOR	88-001	1/1/1988				Marina Management/Under Legal Review
AR Sunriser Canteen/Catering	Across Admin	2006-003	6/14/2006			400	Food Concession
Atlantis Guam	HOR	95-013	2/1/1996			1200	Tourism
Atlantis Guam	HOR	88-004	10/1/1988				Tourism
Ball, Barney	HOR	ST2003-008	10/1/2003			160	Dry Dock
BKA KOKU	Parcel 1	ST 2003-011A	1/2/2004			16000	Scrap Operator
Cabras Marine Corporation	F6	97-028	10/1/1997			5000	Tug
Cabras Marine Corporation	CFS	97-020	8/1/1997	3600			Tug Support
Cabras Marine Corporation	CFS	97-018	8/1/1997			4094	Tug Support
Cabras Marine Corporation	Dockage F6	89-001	10/6/1989				Tug Staging/Renewal Pending
Cabras Marine Corporation	A111	97-015	10/1/1997		980		Admin
Cabras Marine Corporation	A110	97-015	10/1/1997		366.25		Admin
Customs and Quarantine	A106				788		Gov
Dive City Academy	Dog Leg	2002-014	7/1/2002			1434	Watersport
Dongwon Industries Co., Ltd.	A108-109	94-005A	5/1/2001		557		Agent Admin
Fungi Li Fisheries Inc	W1 B2	2005-005	5/16/2005	3465	1512	320	Fishery
GRSL	Seaplane	94-036A	6/1/2000			736	Oil Response
GRSL	HOR	2000-016	4/1/2000			4000	Oil Response/Lease revisit pending
Guam Dolphin Marine Sport Club	Family B	99-025	10/1/1999			3000	Watersport
Guam Transportation & Warehouse Inc.	P-1	2003-003	5/1/2003			5000	Trucker
Guam YTK	HW	2001	6/1/2004				Fishery/Legal
Salt Shaker Yacht Charter	HOR	2006-010	12/7/2006			458	Captain Storage
Horizon Lines LLC.	AA	2002-01	1/1/2002		4155		Agent/Carrier
Inchcape Shipping Services	A116	99-010	2/1/1999		1250		Agent
IT&E Overseas	A225	2004-008	7/1/2004		180		Teleco
JL Baker & Sons	HOR	2003-004	6/1/2003			2400	Trucker
Kloppenburg Ent.	HOR	2005-008				300	Tourism
Kloppenburg Ent.	HOR	2004-006	5/1/2004		320		Tourism
Kloppenburg - Nautilus	HOR	2004-010	8/1/2004			160	Tourism
Kooyoo Pacific Fisheries	W1 B9	2005-006	8/1/2005	288			Fishery
Kooyoo Pacific Fisheries	W2 B3	2004-005	5/1/2004		647		Fishery
Koueki Pacific Corporation Inc.	W1 B11/12	2005-007	11/1/2005	6880	1200	780	Fishery
Kwikspace Guam Inc.	CL	2004-002	2/15/2004			1000	Trucker
Lewis Erik	HOR	ST 2003-006				192	Dry Dock
M.A.Y. Guam Inc.	HOR	2002-019	1/1/2007				Tourism
Marianas Steamship Agencies	AA	96-013	5/1/1996		1116		Agent

Table A3-1.2 Tabulation of Lease Agreements (Continued)

Tenant	Location	Lease No.	Start Date	Warehouse	Office	Open	Purpose/Comment
Marianas Steamship Agencies	AA	2004-007	7/1/2004			160	Agent Storage
Marianas Yacht Club	Apra Harbor	94-043	12/12/1994				Recreation Yacht
Matson Navigation	CFS	96-002	2/1/1996	10800		635	Agent/Carrier
Matson Navigation Company	A115	97-040	2/1/1996		2755		Agent/Carrier Office
Matson Navigation Company	A103-104	96-016	8/1/1996		435		Agent/Carrier Office
Matson Navigation Company	CFS NS	2000-022	5/15/2000			1300	Agent/Carrier
Matson Navigation Company	Portion of Parcel		7/19/2006			45000	Agent/Carrier
Micronesian Dream Co. Inc.	Dock	98-022	5/27/1998				Tourism
Micronesian Dream Co. Inc.	HW	98-023	5/27/1998			320	Tourism Staging
Ocean Fishery LLP	W2 B15	2006-001	3/1/2006	2338			Agent
Ocean Jet Club	Family B	2003-011	11/1/2005			1983	Watersport
Pacific Enviromtal Resource Inc.	Tank 7	2001-006	2/1/2001				Waste Oil
Pacific Network Inc.	W1-U/E	2004-012	7/1/2004			1600	Fishery
Pacific Rim Ice & Fish Packing Svcs Inc,	W1-B1	2000-002	11/16/1999	3600			Agent Storage
Pacific Rim Ice & Fish Packing Svcs Inc,	U/E	2000-002	11/16/1999	800			Agent Storage
Pacific Trucking	CL	ST 2001-013	7/1/2004			2500	Trucker
Palmtopia Enterprises dba Charles Marine Sports Club	Family B	2000-012	8/1/1995			2700	Watersport
Paradise Aqua Corporation	Family B	2000-020	5/1/2000			720	Watersport
RRG Inc.	W1-B10	2004-013	9/2/2004	312			Agent Fishery
RRG Inc.	W1-B13	2001-031		3400	200	320	Agent Fishery
Sanko Bussan	B10	96-011	12/26/1997	4200	1200		Agent Fishery
Skooocumchuck Charters, Inc.	HOR	2005-004	5/1/2005			320	Tourism
Smithbridge Guam	Seaplane	ST2006-08				10000	Construciton
Sunbay Corp	ASBM	93-002	1/20/1993				Food Concession/Pending Legal
Tasi Tours	HOR	99-002	10/27/1998			790	Tourism
Tasi Tours	HOR	98-008	3/1/1998			200	Tourism
Taylor Larry	HOR	ST2003-007	8/18/2003			400	Dry Dock
Tidewater Distributers	W2 - B9	2005-010	11/1/2005	3395			Fishery Agent
Tidewater Distributers	W1/B3-4	2004-004	5/1/2004	6201	510		Fishery Agent
Unitek Environmental Services Inc.	Rt 11	90-003	11/2/1990				Oil Response
Unterberg Jurgen/Guam Oceanier Ent.	A113	94-031	4/1/1994		206		Captain
USDINS	Port Police	94-039	6/1/2001				Fed Gov
V. Angoco Trucking	CL	2003-006	6/1/2003			2400	Trucker
Watson, Jonathan	HOR	2005-002	9/1/2004			160	Captain
Zivkovsky, Michael/Sunbay Corp.	ASBM	94-040	11/1/1994				Food Concession
Total Area (Sq.Ft.)				49279	20491	119142	

Table A3-1.2 Tabulation of Lease Agreements (Continued)

Tenant	SF AREA	LOT #	Start	Option(s)	RENEWED			Payment Term
Casamar Guam	223,865	#5	4/1/1970	(5)-10 Yrs	3/31/2000			Annual
Hanson Cement Inc.		Parcel - A	1/14/1971	(5)-10 Yrs	2/11/2001			Annual
	71,773	Parcel - B	1/14/1971	(5)-10 Yrs	10/1/2001			Annual
Mobil Oil Guam	248,873	#1	3/20/1970	(5)-10 Yrs	3/19/2000			Monthly
	82,799	#3b	3/4/1971	(5)-10 Yrs	4/4/2001			Monthly
Shell Guam Inc.		Dogleg Pipeline	6/13/1969	(3) - 5 Yrs	12/1/2006			Bi-Annual
		GEDA Pipeline	6/13/1969	(3) - 5 Yrs	12/1/2006			Bi-Annual
		Main Pipeline	6/13/1969	(3) - 5 Yrs	12/1/2006			Bi-Annual
	698,247	F-1 Fingertip	6/13/1969	(3) - 5 Yrs	12/1/2006			Bi-Annual
South Pacific Petroleum	140,002	#3a	1/18/1971	(5)-10 Yrs	2/1/2001			Bi-Annual
	217,800	#2	10/1/1969	(5)-10 Yrs	10/1/1999			Monthly
	47,916	Pumpline	7/11/1986	N/A	10/1/1999			Monthly
								Monthly
Annual Revenue plus GEDCA Tract								\$ 1,438,656.03

Appendix 4-1 Comparison of Alternatives

This appendix presents background information on the four alternatives that were developed and analyzed in a preliminary fashion before selection of a preferred alternative. The alternatives and the methodology further discussed in Section 5.4.

Figure A5.1-1a Concept Layout – RTG System

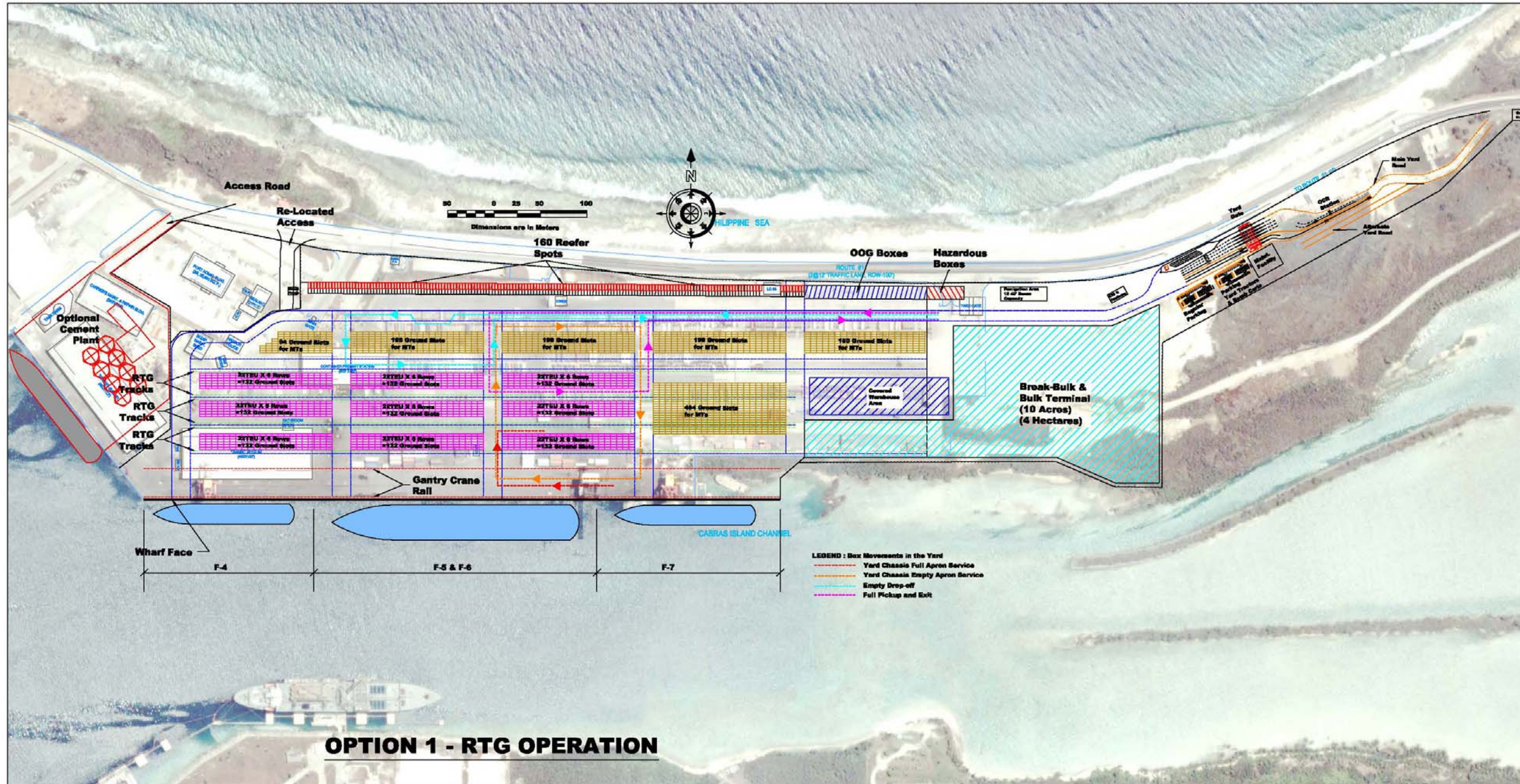

<p>CLIENT</p> <p>JOSE D. LEON GUERRERO COMMERCIAL PORT OF GUAM</p>	<p>CONSULTANT</p> 	<p>PROJECT NAME GUAM COMMERCIAL PORT MASTER PLAN UPDATE</p> <p>FACILITY TITLE MASTER PLAN ALTERNATIVES Alternate Y1 - RTG OPERATION SYSTEM Grounded RTG Dry/Block Stow Empties/ Wheeled others</p>	<p>FIGURE NO.</p> <p>A-01</p>
---	---	---	--------------------------------------

REV 1C DATE 2007/10/26

Figure A5.1-1b Ground Slots & Equipment Needs - RTG

Yard Alternate Y1 - Grounded RTG Dry / Block Stow Empties / Wheeled Others

Ground Slot Summary

Ground Slots Required	Boxes / Year	TEUs / Year	Storage System	Units	Ground Slots Required	Slots Available (Dwg Y1)
Transshipment & Guam:						
Dry-Grounded	101,218	172,071	RTG	TGS	1083	1188
Reefers-Wheeled	6,763	11,497	Trailer	FGS	120	160
OOG-Wheeled	1,054	1,791	Trailer	FGS	21	40
Empties-Grounded	80,942	137,601	Side-Pick	TGS	1245	1352
TOTAL	189,976	322,960			2470	2740

Yard System & Equipment

Container Category	System	Configuration
Full - Dry	RTG	6 Wide x 1 over 4 High, 9 Blocks Ea. 22 long x 6 wide x 4 high
Full - Refers	Shipper Chassis	40' Trailers
Full - OOG	Shipper Chassis	Trailers
Empties (See Layout Alternate Y1 for Yard)	Side-Pick	5 High x Block Stow (See Layout)

Equipment:	No.	Comments
Container Quay Cranes - New	3	
Container Quay Cranes - Existing	1	
RTGs	8	3/Guam 2/Transship stack or 2/Crane
Top Picks	2	
Reach Stackers	0	
Yard Tractors - New	17	5/Crane plus 5 for Other Tasks
Yard Tractors - Existing	8	
Yard Chassis - New	50	
Side Picks (Empties)	6	1 / Crane plus 2 Yard Service
B/B Ship Cranes	2	
Mafi Trailers	8	3 / Ship Crane + 2 Spares
Forklifts 20T	1	
Forklifts 10T	1	
Forklifts 7.5T	2	
Forklifts 5T	6	
Trailer		By S/L or Consignee

RTG Pile - Median Peak Demand

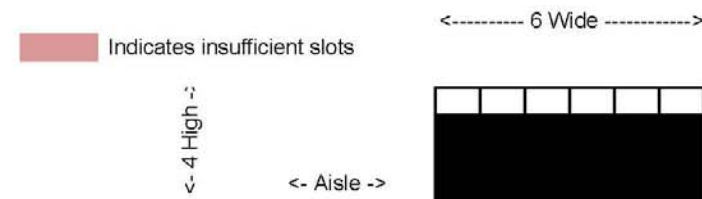

Yard Storage:

- * Utiliz. = 75%
- * Use 70% for stacking by BOL
- * Access to support trucks coming for pickup of inbound boxes
- * Minimize digging
- * Stow in CY by Bill of Lading (BOL) off ship
- * Good computer system will be required to achieve this
- * Customs clears entire BOL
- * Most times customer accepts any box in BOL
- * Occasionally requires particular container
- * Access from above by RTG Crane
- * 4 high containers
- * Across stack with computerized inventory control
- * Max move 3 to get at a specific container
- * Top Pick support elsewhere in yard
- * OOG - On steam ship line chassis
- * Reefers - On steam ship line chassis
- * Empties - block stow by Owner, Type & Size

Figure A5.1-2a Concept Layout – Wheeled + Top-Pick System

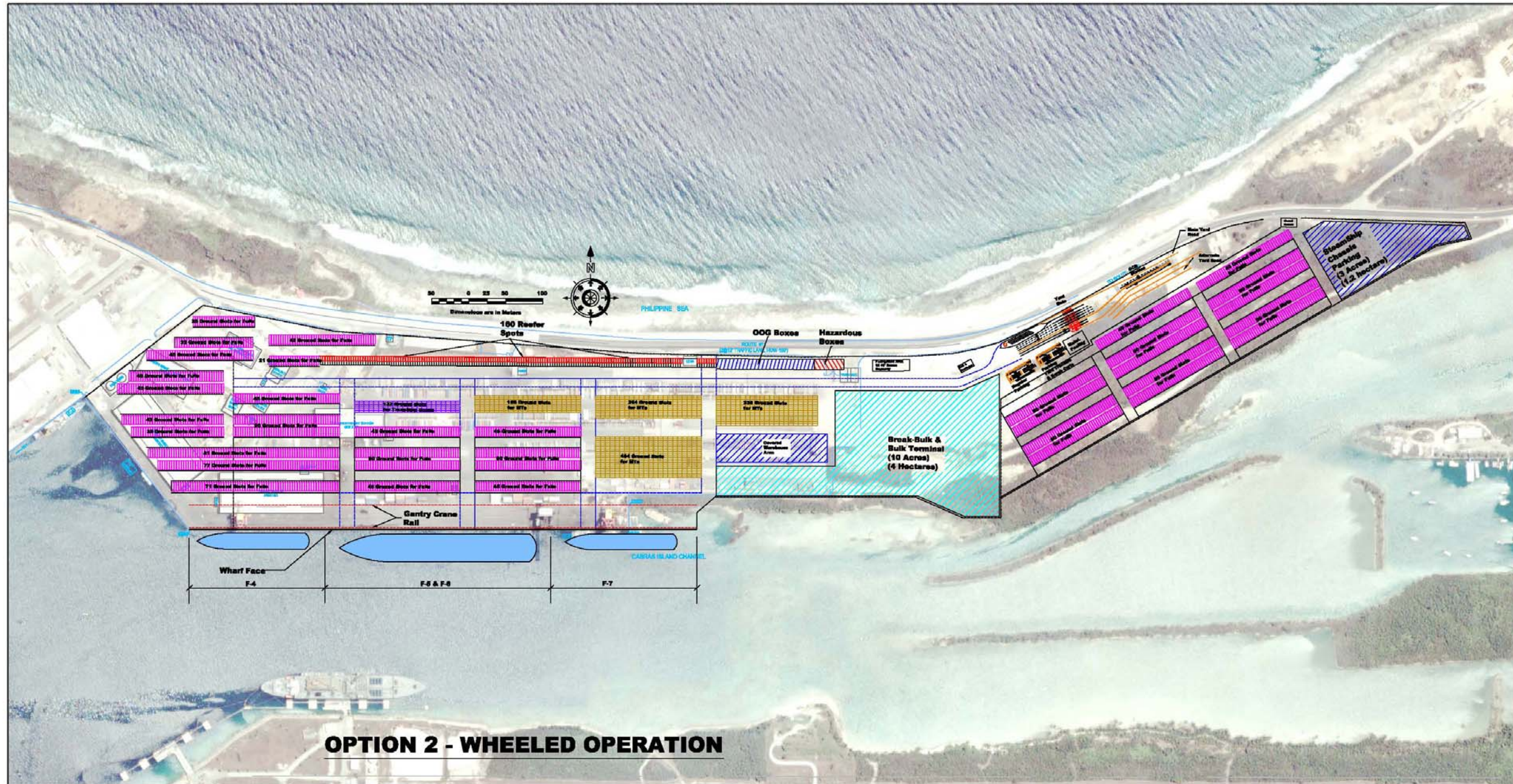

CLIENT JOSE D. LEON GUERRERO COMMERCIAL PORT OF GUAM	CONSULTANT PB 100.	PROJECT NAME GUAM COMMERCIAL PORT MASTER PLAN UPDATE	FIGURE NO. A-02
		FACILITY TITLE MASTER PLAN ALTERNATIVES Alternate Y2 - WHEELED OPERATION SYSTEM Grounded Transshipment / Block Stow Empties/ Wheeled Reefers	

REV. 1C DATE:2007/10/26

Figure A5.1-2b Ground Slots & Equipment Needs – Wheeled + Top-Pick

Yard Alternate Y2 - Grounded Transshipment / Block Stow Empties / Wheeled Reefers

Ground Slot Summary

Ground Slots Required	Boxes / Year	TEUs / Year	Storage System	Units	Ground Slots Required	Slots Available (Dwg Y2)
Transshipment:						
Dry-Grounded	5,062	8,605	Top-Pick	TGS	33	132
All Other:						
Dry-Wheeled	96,156	163,465	Trailer	FGS	1903	1385
Reefers-Wheeled	6,763	11,497	Trailer	FGS	120	160
OOG-Wheeled	1,054	1,791	Trailer	FGS	21	40
Empties-Grounded	80,942	137,601	Side-Pick	TGS	1245	1352
TOTAL	189,976	322,960			3322	3069

 Indicates insufficient slots on current layout
Possibly an off site overflow yard

Yard System & Equipment

Container Category	System	Configuration
Full - Dry	Shipper Chassis	40' Trailers (Some 20')
Full - Reefers	Shipper Chassis	40' Trailers
Full - OOG	Shipper Chassis	Trailers
Empties	Side-Pick	5 High x Block Stow (See Layout)
(See Layout Alternate Y2 for Yard)		

Yard Storage:
 * Only Transshipment Full Cargo is grounded
 * All other cargo Wheeled
 * Utilization 90% for non-Transshipment dry cargo

Equipment:	No.	Comments
Container Quay Cranes - New	3	
Container Quay Cranes - Existing	1	
RTGs	0	
Top Picks	5	3 for Transship Dry + 2
Reach Stackers	0	
Yard Tractors - New	17	5/Crane plus 5 for Other Tasks
Yard Tractors - Existing	8	
Yard Chassis - New	50	
Side Picks (Empties)	6	1 / Crane plus 2 Yard Service
B/B Ship Cranes	2	
Mafi Trailers	8	3 / Ship Crand + 2 Spares
Forklifts 20T	1	
Forklifts 10T	1	
Forklifts 7.5T	2	
Forklifts 5T	6	
Shipper Supplied Trailers	2775	By S/L or Consignee (2000 Plus?)

Figure A5.1-3a Concept Layout – Top-Pick System

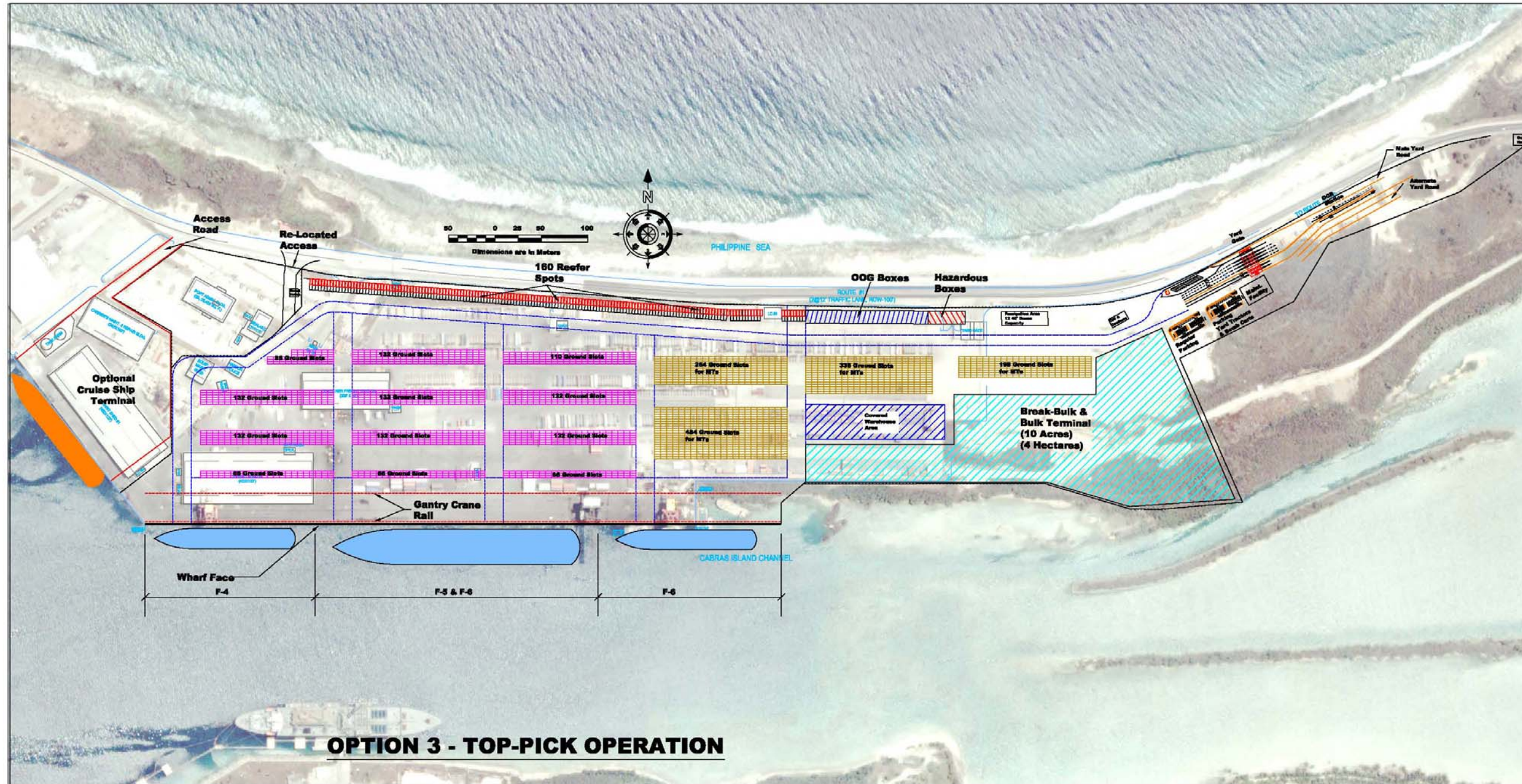

CLIENT JOSE D. LEON GUERRERO COMMERCIAL PORT OF GUAM	CONSULTANT PB 1992	PROJECT NAME GUAM COMMERCIAL PORT MASTER PLAN UPDATE	FIGURE NO.
		FACILITY TITLE MASTER PLAN ALTERNATIVES Alternate Y3 - TOP-PICK OPERATION SYSTEM Grounded Top-Pick Dry/Block Stow Empties/ Wheeled others	A-03

REV 10 DATE:2007/10/26

Figure A5.1-3b Ground Slots & Equipment Needs – Top-Pick

Yard Alternate Y3 - Grounded Top-Pick Dry / Block Stow Empties / Wheeled Others

Ground Slot Summary

Ground Slots Required	Boxes / Year	TEUs / Year	Storage System	Units	Ground Slots Required	Slots Available (Dwg Y3)
Transshipment & Guam:						
Dry-Grounded	101,218	172,071	Top-Pick	TGS	1213	1286
	-	-				
Reefers-Wheeled	6,763	11,497	Trailer	FGS	120	160
OOG-Wheeled	1,054	1,791	Trailer	FGS	21	40
Empties-Grounded	80,942	137,601	Side-Pick	TGS	1245	1282
TOTAL	189,976	322,960			2600	2768

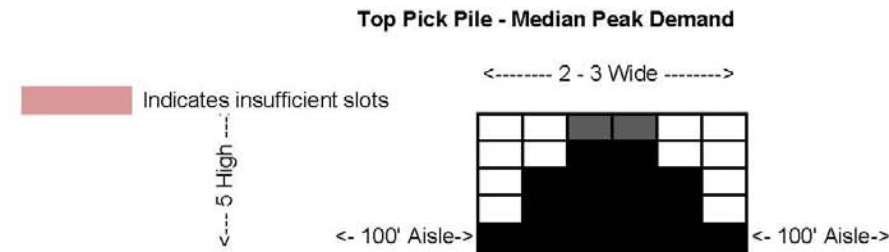

Yard System & Equipment

Container Category	System	Configuration
Full - Dry	Top-Pick	3 Wide x 5 high back to back
Full - Refers	Shipper Chassis	40' Trailers
Full - OOG	Shipper Chassis	Trailers
Empties	Side-Pick	5 High x Block Stow (See Layout)
(See Layout Alternate Y3 for Yard)		

Yard Storage:

- * Utiliz. = 60%
- * Use = 50% for stacking by BOL
- * Access to support trucks coming for pickup of inbound boxes
- * Minimize digging
- * Stow in CY by Bill of Lading (BOL) off ship
- * Good computer system will be required to achieve this
- * Customs clears entire BOL
- * Most times customer accepts any box in BOL
- * Occasionally requires particular container
- * Access on both sides of pile
- * 6 wide row of containers
- * 5 high in center 2 container rows only
- * Max move 8 to get at a specific container
- * Some Reach Stacker support reduces it
- * OOG - On steam ship line chassis
- * Reefers - On steam ship line chassis
- * Empties - block stow by Owner, Type & Size

Equipment:	No.	Comments
Container Quay Cranes - New	3	
Container Quay Cranes - Existing	1	
RTGs	0	
Top Picks	10	2 / Crane Plus 2
Reach Stackers	0	
Yard Tractors - New	17	5/Crane plus 5 for Other Tasks
Yard Tractors - Existing	8	
Yard Chassis - New	50	
Side Picks (Empties)	6	1 / Crane plus 2 Yard Service
B/B Ship Cranes	2	
Mafi Trailers	8	3 / Ship Crand + 2 Spares
Forklifts 20T	1	
Forklifts 10T	1	
Forklifts 7.5T	2	
Forklifts 5T	6	
Shipper Supplied Trailers		By S/L or Consignee

Figure A5.1-4a Concept Layout – Reach Stacker System

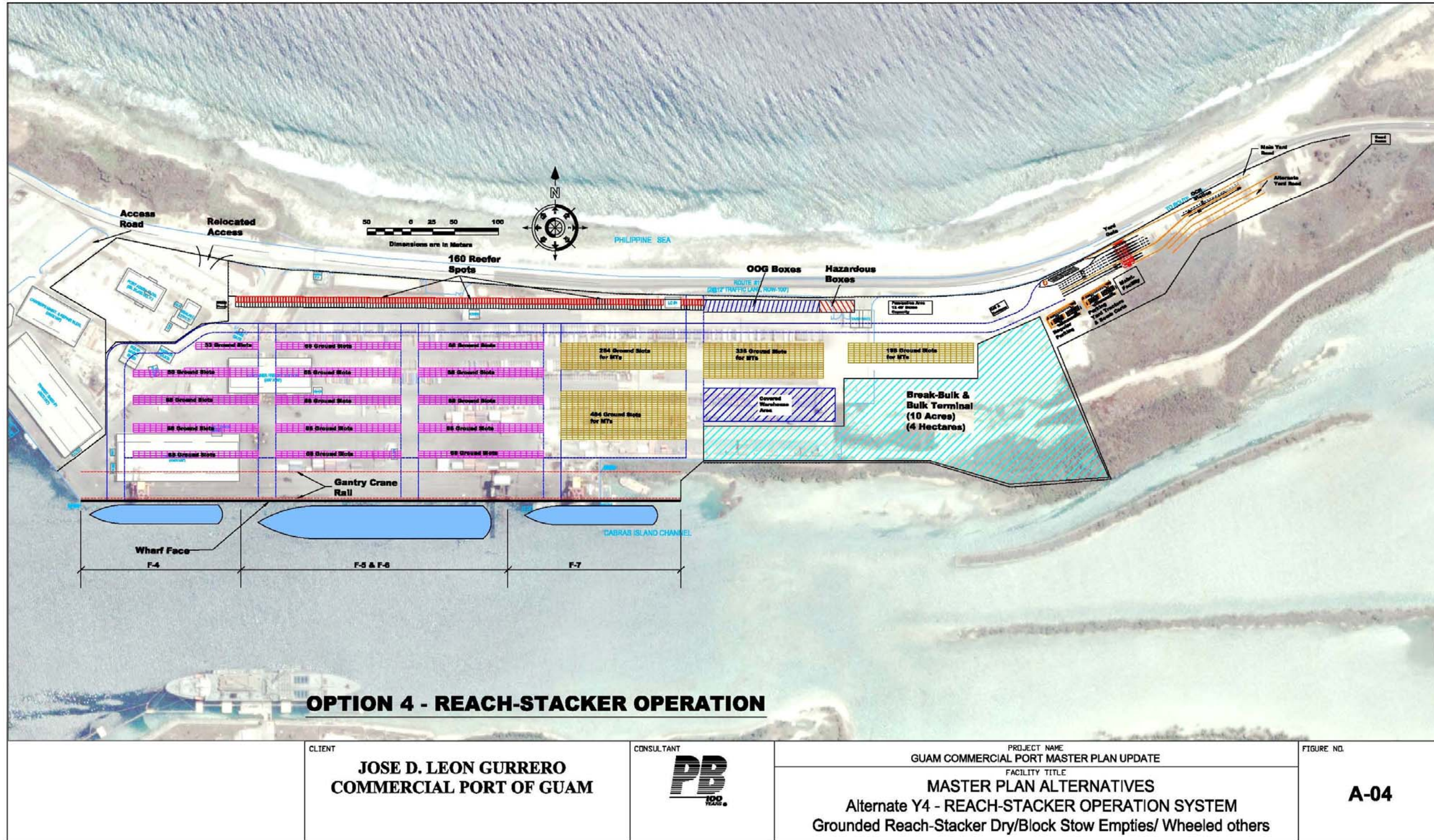

REV. 10 DATE: 2007/10/26

Figure A5.1-4b Ground Slots & Equipment Needs – Reach Stacker

Yard Alternate Y4 - Grounded Reach-Stacker Dry / Block Stow Empties / Wheeled Others

Ground Slot Summary

Ground Slots Required	Boxes / Year	TEUs / Year	Storage System	Units	Ground Slots Required	Slots Available (Dwg Y4)
Transshipment & Guam:						
Dry-Grounded	101,218	172,071	Reach-Stack	TGS	1103	1147
Reefers-Wheeled	6,763	11,497	Trailer	FGS	120	160
OOG-Wheeled	1,054	1,791	Trailer	FGS	21	40
Empties-Grounded	80,942	137,601	Side-Pick	TGS	1245	1352
TOTAL	189,976	322,960			2490	2699

Yard System & Equipment

Container Category	System	Configuration
Full - Dry	Reach Stacker	4 Wide x 1 over 5 High (nearest)
Full - Refers	Shipper Chassis	40' Trailers
Full - OOG	Shipper Chassis	Trailers
Empties	Side-Pick	5 High x Block Stow (See Layout)
<i>(See Layout Alternate Y4 for Yard)</i>		

Equipment:	No.	Comments
Container Quay Cranes - New	3	
Container Quay Cranes - Existing	1	
RTGs	0	
Top Picks	2	
Reach Stackers	8	2/Crane plus Top Picks Above
Yard Tractors - New	17	5/Crane plus 5 for Other Tasks
Yard Tractors - Existing	8	
Yard Chassis - New	50	
Side Picks (Empties)	6	1 / Crane plus 2 Yard Service
B/B Ship Cranes	2	
Mafi Trailers	8	3 / Ship Crane + 2 Spares
Forklifts 20T	1	
Forklifts 10T	1	
Forklifts 7.5T	2	
Forklifts 5T	6	
Trailer		By S/L or Consignee

Reach Stacker Pile - Median Peak Demand

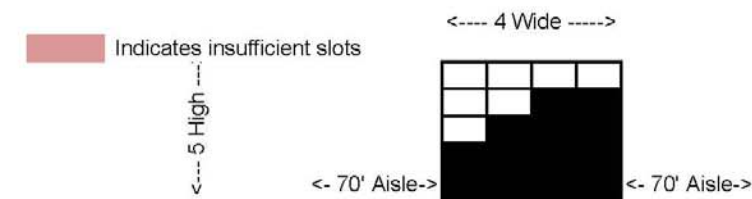

Yard Storage:

- * Utiliz. = 65%
- * Use 55% for stacking by BOL
- * Access to support trucks coming for pickup of inbound boxes
- * Minimize digging
- * Stow in CY by Bill of Lading (BOL) off ship
- * Good computer system will be required to achieve this
- * Customs clears entire BOL
- * Most times customer accepts any box in BOL
- * Occasionally requires particular container
- * Access on both sides of pile
- * 4 wide row of containers
- * 2 high in center 2 containers only
- * Max move 3 to get at a specific container
- * Some Top Pick support
- * OOG - On steam ship line chassis
- * Reefers - On steam ship line chassis
- * Empties - block stow by Owner, Type & Size



Appendix 5-1 Public Presentations & Comments

On February 7, 2008, the Master Plan report was released in draft form for public review and comment. A copy for download was posted on the Port Authority of Guam website. The following presentations and meetings were also conducted.

DATE	TO
2/11/08	Governor, Lt. Governor and staff.
2/12/08	Representatives of Honolulu District USACE, NOAA/U.S. Fish & Wildlife, Guam and Guam Environmental Protection Agency
2/13/08	Chamber of Commerce
2/13/08	Port Shipping Lines or Carriers
2/13/08	Public Hearing at Piti Social Hall
2/14/08	Guam Legislature at the Public Hearing Room
3/5/08	Second Public Hearing at the Port

The date for receipt of comments was first set for March 19, 2008, 5:00 PM but was extended to March 31, 2008 at the request of some stakeholders. The following is a list of written comments that were received through March 31, 2008. Copies of the written comments are attached herewith in this Appendix 5.

Source	No. of Pages
Bureau of Statistics and Plans	4
Carriers Matson, Horizon & Seabridge	2
Fung Li Fisheries, Inc.	1
Guam Chamber of Commerce	2
Guam Environmental Protection Agency	3
Hanson Permanente Cement of Guam (via Carlsmith Ball LLP, attorneys)	6
Rick Agustin, Private Citizen	1
U.S. Coast Guard	4

Bureau of Statistics and Plans

BUREAU OF STATISTICS AND PLANS

(Bureau of Planning)

Government of Guam

Felix P. Camacho
Governor of Guam

Michael W. Cruz, M.D.
Lieutenant Governor

P.O. Box 2950 Hagåtña, Guam 96932
Tel: (671) 472-4201/3
Fax: (671) 477-1812

Alberto "Tony" Lamorena V
Director



MAR 28 2008

MEMORANDUM

To: General Manager, Port Authority of Guam
From: Director, Bureau of Statistics and Plans
Subject: Port Authority of Guam Draft Master Plan Update 2007

The Bureau has reviewed the subject Draft Master Plan Update 2007 for the Port Authority of Guam (PAG) to provide for the needs of ocean commerce, shipping, recreational and commercial boating and navigation of the territory of Guam. The PAG operates the largest U.S. deepwater port in the Western Pacific serving as the only commercial seaport and the main lifeline of all cargo entering the island. It is also a vital part of Guam's economic infrastructure handling 95% of the island's total imports (civilian & military), loading and offloading of cargo for Guam and Micronesia. It serves as the transshipment hub for the entire Western Pacific Region. However, due to the magnitude of the potential cargo volumes associated with the proposed Marine relocation from Okinawa to Guam, an Impact Assessment on the PAG facilities is being prepared in order to implement needed changes and/or upgrades to accommodate the anticipated activities at the port.

Potential improvements to be investigated include the proposed improvement in the Commercial Port's infrastructures, relocation of the break-bulk yard, expansion of F-7 and constructing a larger and deeper anchorage area within the PAG to accommodate larger vessels. Many of the larger vessels require additional time to maneuver in the narrow branch channels, thereby increasing operating costs to shippers. Mitigation measures have to be identified and viable alternatives developed. Fairly simple sensitivity test must make sure that there is a reasonable or good solution and that great risk are not being taken with apparently the preferred options. It is critical that an Environmental Impact Statement (EIS) is prepared for all the planned port improvements.

This current Draft Master Plan includes recommended changes in Land Use and Zoning, such as change of the areas that are dependent for their operations on access to deep-draft oceangoing vessels with associated water borne transportation needs directly to or from the facilities, to "Marine Industrial Designation," as follows:

Land Use Change #1, in Figure E6.5-1 encompassing Outhouse Beach, Golf Pier and Scaplane Ramp be changed to "Marine Industrial" zone.

Bureau's comments: The land area is too limited, with the exception of the seaplane ramp area, for industrial uses; the lack of storm water infrastructure to contain any pollutants from spilling directly into the marine environment. We do understand in the long term this area is being recommended for filling in to create more wharf areas. We are concern that there are still marine environments and coral reef habitat in the immediate off-shore area that must be taken into account prior to those plans being finalized. It may need to be surveyed and the amount of compensatory restoration/mitigation be determined by using the Habitat Equivalency Analysis (HEA) similar to Kilo Wharf.

Land Use Change #2, the land use for the designated area highlighted “Recommended Land Use Change #2” in Figure E6.5-1 be changed from “Open Space” to “Industrial.” This sets aside a contiguous area within the Commercial Port with more flexibility for fulfilling the needs of the various terminals.

Bureau’s Comment: Our concern with the Industrial Zone designation for the area north of the Route 11 and east of the fuel storage tanks is its location on a very narrow strip of land, part of which is on the existing limestone bluff that once made up Cabras Island. This bluff protects the Port assets from the fury of the ocean that lays just seaward of it. The rest of the bluff has been quarried down to the road level along the whole stretch of road fronting the Port’s container yard. Unfortunately, this leaves the yard vulnerable to high winds and waves, as was evident in previous typhoons, including Typhoon Ponsona in 2002. As a result of this vulnerability there is an application to build a seawall where a naturally occurring limestone bluff used to exist. The remaining existing bluff should be preserved to act as a protective barrier for the Port.

Land Use Change #3 in Figure E6.5-1 be changed from “Open Space” to “Marine Industrial” use. This change would relocate Route 18 to the south and around this zone in order to provide land adjacent to deep draft navigation in Cabras Channel.

Bureau’s comment: The recommended Marine Industrial (MI) designation for the area near the Marianas Yacht Club is known to be primarily comprised of mangrove and wetland areas. We feel that the footprint of the recommended MI designation should be reduced to stay within the fast lands. The proposed rerouting of Route 18 appears to be within the wetland areas. With the limited amount of mangroves in the wetlands of Guam, the Bureau recommends that this area be reduced to save the wetland areas.

Family Beach and Hotel Wharf

The Bureau is encouraged by the fact that the Dogleg Pier area has been retained as a place for water recreation activities. We hope that this will also mean an increase of public access to the local community. We recommend that the Family Beach area be also designated for Water Recreation and not as a Fishing Facility, as shown in Figure 6.5.1. Those uses may not be compatible.

The Hotel Wharf Area designated as Dinner Cruise could also be moved to the west to be adjacent to the Water Recreation areas. The Dinner cruises and water recreation uses seem to be a good mix that compliment one another. Tourists can spend time on Family Beach and on the water and go on a dinner cruise before heading back to the hotel.

6.6.4.2 Entrance/Exit Facility

It is not clear where this main entrance/exit is proposed to be. Currently there is a check point on Route 11 that was erected after the World Trade Center Bombing in 2001. The Main entrance to the terminal area is also a gated entrance. We have concerns about restricting public access to marine resources in the other portions of Cabras Island that are supposed to be unrestricted areas. Such Public Facility areas include the Family Beach and Dogleg Pier area to access the coral reefs and Outer Apra Harbor water recreation areas. To the maximum extent possible, we agree that the Port should provide a separate public access to those public areas. As indicated in Section 6.6.5 Public Facilities, “It would be preferable that civilians using the public facilities would not have to enter and exit through the main terminal gates. Therefore, these public facilities must be physically separated from both the commercial and military facilities.”

6.7 Marinas, General Operational Improvements

The plan does point out that PAG has the three (3) Marinas that “Together they provide opportunities for most of the public’s small boat needs.” However, we agree with the plan when they point out that “the condition of these facilities does not allow the public to benefit fully from their amenities.” The PAG should implement the Plan’s general improvements recommended for the Marinas and specific action items for each Marina.

The really poor and unsafe conditions documented in this plan at some of the Marinas have existed at some of these facilities for quite a few years. We believe they may have a direct detrimental effect on our visitor industry. Each day these facilities are frequented by our visitors and the local community. If, PAG does not have the funding to upgrade and maintain these facilities then they should seriously consider privatizing their operations.

6.9 Site Utilities and 6.9.2 Storm Water Drainage System

We do concur with the plan that should major upgrades to the utilities be required, a full review on the utilities routings as a whole is recommended, especially since some of the existing utilities (e.g. storm drain direct discharge to sea and mixed supply for fire water and domestic water) were designed to meet the codes or engineering practices of some 35+ years ago. As recommended, a code compliance check would be necessary.

Especially important to the Bureau’s Guam Coastal Management Program(GCMP) is the Storm Water Drainage System, under its Nonpoint Pollution Program. We concur with the plan that “instead of directly discharging to the sea as per the existing system, an oil/sediment in-line unit is recommended to provide basic treatment to the storm water before discharging to the sea. A gravity drainage system with additional new outfalls would be required for F-7, the Break-Bulk & Bulk Terminal, and the extended container yard” is highly recommended.

Phasing

Though there is a sense of utmost urgency in order to complete the modernization outlined in the plan because of the impacts of the proposed military expansion, we do caution that as much as reasonably possible, the modernization improvements should be phased properly to minimize disruptions to the operations of the port as well as to the local community, and to minimize adverse effects to the environment. We also urge the Port to assess cumulative and secondary impacts of the DOD developments as part of the EIS.

Environmental Concerns

The increased awareness of environmental conditions has significantly influenced port planning and operations. The dredging or deepening of channels to maintain their navigability involves removing sediment, rock, and debris from the channel bottom. We are concern whether the mud that’s being dredged is contaminated and posses a danger to nearby areas. Because dredging disturbs the bottom material as well as the plants and animals living in the water, its environmental impact depends partly on the type of channel bottom. If channel bottom material is contaminated, disturbing the sediment can further degrade the environment by distributing or releasing these contaminants. The disturbance of contaminated sediments is usually an issue when dredging and then finding and identifying proper/duly approved disposal sites for these contaminated sediments is another concern. In dredging a lot of high-value marine habitat might be destroyed. The dredging may also literally change the way water circulates. The other major concern is the turbidity in the dredge area. With regards to dredged materials, please note that a Memorandum of

Understanding (MOU) was signed on April 12, 2001 between the Department of the Navy and the Government of Guam for the beneficial use of dredge material from the Navy construction dredging project in Inner Apra Harbor for proposed Port Authority of Guam (PAG) construction Projects. We understand that the material to be disposed of at this offshore site will be considered "clean" or "suitable," but it is not clear exactly what standards are used to determine if the material is suitable or not. PAG development within the Zone requires consideration of many environmental factors that impact water and air quality. Many of the Critical Area regulations that control development consider impacts on water quality and seek to encourage the identification of best practices to reduce run-off associated with new development.

In addition, coordination and improved communication between the Government of Guam agencies must continue throughout the review and construction process. In order to ensure that proper monitoring of impacts to natural resources are properly monitored, it is critical that baseline data be collected. This effort needs to be initiated as soon as possible to ensure that data is collected prior to the start of any project.

Overall, it is important that the EA/EIS and the Final Master Plan be provided to all concerned Federal and Government of Guam resource agencies for Federal Consistency review in order to thoroughly review all types of activities associated with the proposed development. Please refer to the Procedures Guide for Achieving Consistency with the Guam Coastal Management Program. The CZMA federal consistency requirements are found at 15 CFR Part 930.

The Bureau commends the PAG for taking this initiative, working diligently to reach the point where conceptual recommendations can be presented for consideration by decision makers. Thank you for giving us the opportunity to comment and should you have further questions or concerns with regards to our comments please do not hesitate to contact our GCMP Administrator, Ms. Evangeline Lujan at 475-9672, email: vangeluja@yahoo.com or Amelia F. De Leon at 475-9669.



ALBERTO A. LAMORENA V
Director

cc: GEPA
DoAg
DPR
DLM
DPW
ACOE
Mayor of Piti
Office of the Governor
JPark/BillMillhouser

Carriers Matson, Horizon & Seabridge

Port Authority of Guam Master Plan Comments

Carriers submitting input: Matson, Horizon, Seabridge

- 1) Carriers agree with the choice of a "Wheeled + Top Pick" operation.
- 2) Of the two terminal layout alternatives presented in Section 5.5 Selected Alternative (5.5-1 and 5.5-2), the carriers support 5.5-2 or what is called Break-Bulk West Variation for the following reasons.
 - It keeps the container yard as one continuous yard with no mixture of breakbulk cargo traffic.
 - It keeps the hardened area for container loads on chassis and serves as a backup should it be needed to ground containers. Putting breakbulk cargo there makes it harder to convert the yard if needed.
 - BB cargo West also keeps the distance between the pier and the laydown area a shorter distance than working the ships at F4-5 and traveling through the container yard to store the cargo.
 - BB cargo in the "EAST" layout also requires more equipment to move breakbulk cargo from shipside to yard area since it is a greater distance to travel.
 - Although future military RORO ships may require berthing at F7, most of that cargo will be RORO. So cargo can be staged in the BB WEST area and "driven" to the ship no matter what pier it is located at.
- 3) A suggestion is to have a separate lane to handle breakbulk cargo at the terminal gate so that container traffic does not mix with breakbulk cargo traffic. Another option would be to keep a separate gate area for breakbulk as they do today and that is the gate area near the current maintenance shop.
- 4) Both terminal layouts call for the removal of the warehouse that houses Matson, Horizon and Cabras Marine maintenance facilities. We would like to see these facilities relocated to the area outlined as Industrial Park on page 116 which outlines the recommended land use. Carriers would continue to lease the warehouse from PAG.
- 5) Section 6.1.10 (terminal operating system) is critical to the success of the port efficiently handling the increased throughput in the years ahead. This new system should be put in place in the next twelve months so that any systems issues could be addressed prior to the start of the buildup.
- 6) Section 6.1.11 (labor availability & productivity) professional

training be provided to the various categories of skilled labor in order to operate new technologies...

- 7) Section 2.4.6 Fire Protection System.....page 58. We support the recommendation of the fire alarm system being connected with the local fire station. Although the port of Guam does not have a fire station on site, it should ensure that the Guam Fire Department has personnel trained to handle shipboard fires just as the Guam Airport Authority has fire fighters trained to handle aircraft fires.

2.3.1 Berths F-2 through F-6

Maintenance and Operational Improvements

"It was clear during the condition survey that the structures have not been maintained on a regular basis. The damage to the fenders and the coping beam is extensive and also no corrosion protection system has been employed in order to protect the sheet piles on the older structures. Major work to replace the sheet pile supported sections of the facility will be necessary as part of a modernization plan for the Port of Guam."

2.3.2 Container Crane Rails on at Berths F-4, F-5 & F-6

Maintenance and Operational Improvement

"... due to difficulty in crane movement along the rails. The permanent damage that happened to the structure during the 1993 earthquake may have caused the piles to move sideways due to plastic deformations. This could be one of the factors that caused the rails to move making it difficult for the crane travel along the rail. Some strengthening or total replacement of the rail supporting structure may be necessary in order to remedy this problem. This should be investigated as part of an overall modernization program for the terminal."

Paul

Horizon

Fung Li Fisheries, Inc.

3/4/08 10:45
Port Authority of Guam
General Manager's Office
RECEIVED



FUNG LI FISHERIES, INC.

ADDRESS: 1026 CABRAS HWY #300 PITI, GUAM 96925
TEL: (671) 475-7502~4 FAX: 472-4247

Mr. Carlos Salas, Interim General Manager
Port Authority of Guam
Government of Guam
1026 Cabras Highway, Suite 201
Piti, Guam 96925

March 04, 2008

Attn: Dot Harris, Chief Planner

Subject: PAG Draft Master Plan

Re: Concurrence with respect to fishing industry operations at warehouse #1

Hafa Adai Ms. Harris,

Thank you for your work in successfully managing the on-going Port Maser Plan.

We have reviewed the draft plan and concur with the recommendation that Warehouse #1 be reserved for the fishing industry, and current tenants may remain in place. It does appear, however, that this space assignment may not be permanent., so we respectfully request that the Port's master planning scope reach beyond this recommendation and lay the groundwork for permanent accommodations for Guam's fishing industry.

Perhaps you would find it useful to organize a task force comprised of Port officials and representatives of Guam's fishing industry to start this next phase of planning. If so, we will be pleased to assist.

Sincerely,

SHENG YI HUNG
S.Y. Hung, President

Guam Chamber of Commerce



GUAM CHAMBER OF COMMERCE
PARTNERS IN PROGRESS

March 18, 2008

3/18/08
Port Authority of Guam
General Manager's Office
RECEIVED

MONTE MESA
Chairman
Port Authority Board of Directors
1026 Cabras Highway, Suite 201
Piti, Guam 96915

RE: PORT MASTER PLAN

Dear Mr. Mesa,

Thank you for the opportunity to submit comments relative to the Port Authority of Guam's Draft Master Plan Update 2008.

The presentation made to the Guam Chamber of Commerce Board of Directors and Maritime Affairs Committee (MAC) members on February 13, 2008 was well received. At the onset, we would like to reiterate our concerns about the critical need for the Port of Guam to not only move forward with efforts to grow its capacity to support the ongoing and planned military buildup, but more importantly to support the natural growth of our local community.

Island merchants are behind the Port's initiatives for steadfast improvements because the loss of military cargo movements will leave a tremendous void and result in a commensurate increase in port costs for downtown businesses. These costs will ultimately be borne by Guam's residents.

We are encouraged by the draft Master Plan Update, as it addresses our major concerns such as acquisition of necessary equipment and modernization of facilities to improve overall Port operations. However, in order for the Master Plan to achieve success, the following must be considered:

1. Establish realistic timelines for execution;
2. Identify adequate sources of funding;
3. Maintain continuous communication throughout the execution process via stakeholders; and
4. Consider and incorporate concerns addressed by Port users as listed in enclosed document.

Guam Chamber of Commerce
Letter to Port Authority of Guam
Re: Port Master Plan Update 2008
March 18, 2008
Page Two

The Guam Chamber of Commerce stands ready to assist, and looks forward to being an active participant in carrying out the solutions presented in the Port Master Plan.

Sincerely,



LAURA-LYNN DACANAY
Chairwoman, Board of Directors

Enclosure

cc: Maritime Affairs Committee, Guam Chamber of Commerce

Guam Environmental Protection Agency

GUAM ENVIRONMENTAL PROTECTION AGENCY

AHENSIAN PRUTEKSION LINA'LA GUAHAN

P.O. Box 22439 CMF • BARRIGADA, GUAM 96921 • TEL: 175-163879 • FAX: 177-9102

MEMORANDUM

TO: General Manager, Port Authority of Guam

FROM: Administrator

SUBJECT: Jose D. Leon Guerrero Commercial Port of Guam Master Plan Update 2007 Report

Buenas! The Guam Environmental Protection Agency (Guam EPA) has reviewed the 393 page Draft of *Jose D. Leon Guerrero Commercial Port of Guam Master Plan Update 2007 Report*. We offer the following comments, questions and suggestions regarding this plan and its implementation.

1. We suggest that additional data on fisheries use and transshipment at the Commercial Port be included.

- Future demands projections did not include fishery demands.
- This plan should recognize that multi-year cycles of regional tuna stocks availability near Guam and farther east, based on El Nino oceanic changes, affects demand for use of Guam facilities. Data from longer term, many year fisheries statistics should be used for planning purposes.
- This plan should distinguish between Long Line and Purse Seine fisheries for tuna.
- Do purse seiners use Port Authority of Guam (PAG) facilities only for repair at Casamar?
- Do purse seiners ever transship at Guam?
- Do they refuel at Guam?
- Are visits influenced by advantages in fuel pricing for fisheries vessels on Guam?
- Will this change in the future?
- What are the plans for fisheries facilities at Hotel Wharf?
- The plan should tie in availability of air cargo space from Guam to Asian markets for fresh fish.
- If port needs for the fisheries industry are not accommodated during the military build-up, the value to Guam of the large, long term and sustainable tuna fishery in the region may be lost. It would be difficult to re-establish fisheries use of the Port of Guam if it were lost during the period of expanded military cargo needs.

2. The proposed Open Space Zone on the peninsula leading to the Delta and Echo Wharves and the Marianas Yacht Club needs to include a buffer, **with no development allowed**, surrounding the existing mangrove and fisheries preserve area of Sasa Bay.

- This mangrove community and adjacent mud flats are unique habitats among all the Mariana Islands and are critical to fisheries productivity.

- This mangrove stand is recognized as the largest mangrove community on US soil throughout the entire Pacific and, therefore, requires special attention and preservation.
3. The plan should mention archeological sites at the Open Space Zone around the Marianas Yacht Club, in Section. 2.1.4.
4. More discussion is needed on the Port Authority of Guam's Deep Draft Harbor proposal and DEIS in Section 2.3.1.9 .
- What is its status?
 - How does it relate to this master plan?
 - Will it be implemented in future years?
5. No information is provided about seawater fire fighting facilities at the commercial fuel storage area. (Sections 2.4.1 and 2.4.6.)
6. Support for cement carriers. (Section 2.5.4.)
- The plan should include projections of quantities of cement needed in future years.
 - The feasibility of dredging for bulk cement carriers and partnerships with the cement carriers to do this as part of the urgent development should be addressed.
7. Environmental Impact Assessment.
- An Environmental Impact Statement is needed for the planned port improvements.
 - The urgency of implementing the port plan suggests that immediate steps are necessary to expedite the NEPA and permitting processes.
 - It is recommended that the immediately needed developments (not all the longer range plans) such as F-7 dock face construction, dredging for access at F-7, and container yard expansion should be the subject of an expedited EIS.
 - Much information on the area to be impacted off F-7 is available from earlier studies on biological resources, sediments, currents and water quality, thus, saving the PAG time and money in the NEPA process, compared to the Deep Draft Harbor DEIS.
 - Quality of the sediment to be dredged requires urgent analysis to allow for its planned disposition and to determine costs for its storage, use or treatment if necessary.
 - Cumulative impacts of DOD developments and other proposed developments in Apra Harbor will need to be assessed as part of the EIS.
 - Local expertise (e.g., the University of Guam Marine Lab, or local environmental firms) is available and can provide better, cheaper and quicker environmental studies and EIS's than contracted off-Island companies.
 - The option of the PAG contracting such studies through its own RFP should be considered, rather than waiting for the Army COE to do this, which would take a longer time and much greater cost.

- CWA Section 404 and 401 permits as well as historic site clearance and Endangered Species Act Section 7 and Essential Fish Habitat reviews should be initiated to run concurrently with the EIS process as much as possible.

Thank you for the opportunity to review the draft plan and provide input to your planning process. If you have any questions regarding our comments, please contact our Chief Planner, Mike Gawel, at 475-1646 or email: Mike.Gawel@guamepa.net



LORILEE T. CRISOSTOMO

Cc: Director, Bureau of Statistics and Plans, Attn.: GCMP
Director, Dept Ag., Attn.: DAWR
Director, Dept. Parks and Recreation, Attn.: HPO
Administrator, GEDCA
ACOE, Guam
US F&WS
NMFS
US EPA

Hanson Permanente Cement of Guam (via Carlsmith Ball LLP, attorneys)

CARLSMITH BALL LLP

A LIMITED LIABILITY LAW PARTNERSHIP

BANK OF HAWAII BLDG., SUITE 401
134 WEST SOLEDAD AVENUE, P.O. BOX BF
HAGÁTÑA, GUAM 96932-5027
TELEPHONE 671.472.6813 FAX 671.477.4375
WWW.CARLSMITH.COM

DIRECT DIAL NO.:
X302

DLEDGER@CARLSMITH.COM

OUR REFERENCE NO.:
031459-00009

2/26/08 2:35pm
Port Authority of Guam
General Manager's Office
RECEIVED

February 26, 2008

VIA HAND DELIVERY

Mr. Carlos H. Salas, Interim General Manager
PORT AUTHORITY OF GUAM
Suite 201
1026 Cabras Highway
Piti, Guam USA 96915

Re: Draft Master Plan:
Hanson Permanente Cement of Guam, Inc.'s proposed investment
at the Port of Guam

Dear Mr. Salas:

Our firm represents Hanson Permanente Cement of Guam ("Hanson") -- a Port of Guam tenant for nearly 50 years. We are writing to you in response to the Draft Master Plan recently presented by way of public hearing.

Of particular interest to Hanson and our office is that portion of the Master Plan concerning the need to increase capacity to import cement to Guam. As explained below, Hanson has already submitted to the Port Authority a proposed means to supply the anticipated additional capacity and, what's more, is prepared to undertake such capital improvement at its own expense. In other words, Hanson is offering a "public-private partnership" under which the "public" portion of the investment of funds is basically nil.

1. Background

On October 30, 2007 Derek Sadler, Guam-based General Manager of Hanson, and Dave Hummel, California-based President of Lehigh Hanson West Region¹, met with former Port Gen.

¹ Following a merger with Heidelberg Cement, Lehigh Hanson is the 3rd largest construction materials producer worldwide with 70,000 employees operating in 50 countries. Lehigh Cement (North America) sold approximately 14.9 million tons of cement in 2006 and operates 13 cement plants and 60 cement terminals in North America.

Mgr. Ken Tagawa to discuss Hanson's desire to increase capacity to import cement, and in particular to meet demand for cement during the military build up.

On December 5, 2007, Hanson wrote to Mr. Tagawa to follow up on the October 30th meeting. A copy of that letter is attached as Exh. A. Unfortunately, with Mr. Tagawa's resignation the dialogue stopped, hence this letter to you in your capacity as Interim Gen. Mgr. .

2. Hanson's business and need to increase import capacity.

Hanson imports bulk cement from foreign countries, primarily Japan, and sells it to customers on Guam, primarily redi-mix concrete producers Hawaiian Rock and Perez Bros. Hanson imports the cement with ocean-going bulk carrier vessels and stock-piles the product at its plant. As you know, Hanson's plant is located next to Shell's F-1 facility on land leased from the Port under a sublease agreement dated January 14, 1971.²

Hanson's facilities include a concrete wharf which it constructed, owns, and maintains. However, the Port's harbor water adjacent to Hanson's wharf is not deep enough to berth the vessels used to import the cement. So far, Hanson has mitigated the effect of the shallow water by installing a "breasting barge." The "breasting barge" essentially extends the concrete wharf into deeper water where the vessels are able to berth and off-load cement. Hanson pays the entire cost for the breasting barge. Even with the breasting barge, the vessel must light-load to avoid grounding.

This already marginal situation is made worse by the fact that the vessels coming on line to transport greater quantities of cement are larger and draft even more water. These vessels, unless likewise light-loaded, will be unable to berth at the outer face of the breasting barge. In other words, greater water depth is the only answer to meet the anticipated demand for cement.

3. Hanson's proposed investment in Port facilities

Plainly the stakes are high for the Port of Guam and the entire island. Equally plain is the difficult task of funding the improvements needed to meet the Master Plan's stated goals. Delay in implementing the Master Plan due to lack of funding, and delay in importing a sufficient quantity of cement, would have a marked negative impact on construction and in turn the island economy.

Initially, Hanson proposed dredging adjacent to its wharf but as acknowledged in the Master Plan, dredging is an expensive and time consuming project requiring, among other things, lengthy impact studies and difficult to obtain permits. As a result, more recently, Hanson proposed (to Mr. Tagawa) that Hanson construct a free-standing dolphin mooring system

² Prior to signing this lease in 1971, Hanson operated for 12 years from a different location in the commercial port. Plainly, Hanson has a long history as a good and valuable tenant at the Port.

adjacent to Hanson's wharf to achieve the water depth needed to accommodate large cement carriers.

Simply stated, Hanson proposes a means to meet the Master Plan goal for increased capacity to import cement. With increased water depth for full load vessels Hanson will be able to meet the island's demand for cement, just as it has for the past 49 years.³ Plainly, larger cargo vessels than currently possible with the existing harbor depth will be needed. At present Hanson's capacity to meet the increased demand is constrained only by the too-shallow water adjacent to Hanson's wharf. To solve the load limit problem Hanson proposes to construct a dolphin mooring system in deeper water, at no cost to the Port. In exchange, Hanson would have exclusive use of the mooring system.⁴ In the unlikely event Hanson ever vacates its leased property, Hanson would relinquish all rights in the mooring system to the Port. In sum, the Port would receive a substantial upgrade to its facility and meet a stated goal of the Master Plan -- *without investment of its own funds.*

Hanson seeks your assistance in moving forward with the proposed investment and urges you to bring this matter to the attention of the Port Board at your soonest opportunity. Hanson believes the Board would readily see this proposal as the win-win situation it truly is. Mr. Sadler and I are available to attend a Board meeting to further explain the water depth problem and the proposed solution. Likewise, we are available to meet with you personally.

4. Conclusion

While foreign cement companies may be looking at Guam as an opportunity to sell cement during the military build up, no such company likely considers Guam a long term investment. On the other hand, Hanson has been here for 50 years and is looking forward to another 50. While foreign companies may be seeking access to Cabras Island and construction of temporary facilities to store cement, Hanson is seeking to provide the Port with a substantial capital improvement as means to not only support construction associated with increased military and private construction but to position itself, and the Port, to continue to meet the island's demand for cement long after the construction boom winds down.

///

///

³ Here is a convenient juncture to point out that of the five reported cement shortages discussed during the public hearing on the Master Plan, only two involved Hanson. The other three instances stemmed from a local contractor trying to import its own cement and then failing to meet its own needs. This further highlights that the business of importing cement should not be undertaken by companies unable to deliver.

⁴ By "exclusive" we do not mean that no other vessel could ever utilize the mooring. Rather, as in past instances when the Port lacked sufficient wharf space for vessels, Hanson would accommodate like instances so long as doing so would not prevent Hanson from berthing a cement vessel.

Page 4 of 4
Mr. Carlos. H. Salas
Interim General Manager
PORT AUTHORITY OF GUAM
February 26, 2008

Please contact me if you have questions and to schedule a meeting meet with us and Mr. Sadler.

Best regards,

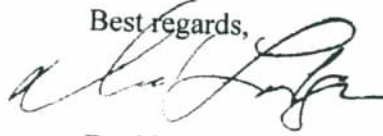
A handwritten signature in black ink, appearing to read "David Ledger", written in a cursive style.

David Ledger

cc: Mr. Monte Mesa, Chairman, Board of Directors, Port Authority of Guam
Enclosures: Exhibits A

4827-5503-8722.1.031459-00009

EXHIBIT

“A”

December 5, 2007



Mr. Kenneth T. Tagawa
General Manager
Port Authority of Guam
1626 Cabras Highway, Ste 201
Piti, Guam 96915

Hanson Aggregates
West Region
P.O. Box 639069
San Diego, CA 92163-9069
9229 Harris Plant Road
San Diego, CA 92145
Tel 858-277-5481
Fax 858-277-4517
www.hanson.com

RE: Kttagawa@portofguam.com

Dear Mr. Tagawa,

Thank you again for taking time from your busy schedule to meet with Derek Sadler and me to discuss our cement terminal. Serving the island for nearly fifty years now, we are truly committed to additional investments that may be required for adequate gearing of any military build-up efforts. As discussed, however, we appear to be perplexed by shifting positions from various legal analyses. On the one hand, the Port claimed subsurface entitlement during the Federal Court proceedings, but now, in the latest correspondence, asserts a "non-jurisdictional" position.

Simply stated, we are businessmen with a long-established and stellar reputation on-island to meet the communities' needs. As discussed, we genuinely seek your assistance in breaking any log-jams that impede our ability to install dolphins in deeper water to support larger cargo ships. Plainly, larger cargo ships than currently possible with existing berthing conditions and harbor depth will be needed to meet increasing demands for construction related to the build-up. At present our capacity to meet increased demand is constrained only by vessel load limits imposed by the shallow water conditions adjacent to our wharf. Our proposed investment of constructing a dolphin mooring system in deeper water will solve the load limit problem by allowing us to bring in vessels of sufficient capacity. We urge you to please bring this matter to the Port Board of Directors at your soonest opportunity. While the timing of the military build-up is certainly fluid, we believe also that timing is of the essence on this matter in order to properly plan and fund. Mr. Sadler would be available to attend a Board meeting to explain the problem and our proposed solution. Significantly, as we explained during our meeting, the port would receive a substantial upgrade to its facility without investment of its own funds. We are of the mind that the Board would readily see this proposal as the win-win situation it truly is.

As the change-agent hired to support growth in Port activity, your offer to review and provide guidance is both welcomed and appreciated. Please advise Derek of a suitable time frame to meet again on these matters.

Very truly yours,

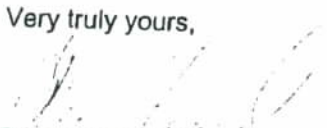

Dave Hummel
President

cc: Mr. Derek Sadler, Hanson Permanente Cement

Rick Agustin, Private Citizen

Nira Ratnathicam

From: comments@portofguam.com
Sent: Sunday, March 09, 2008 6:44 PM
To: Agustin, Rick
Cc: Ratnathicam, Nira; glenn
Subject: RE: Ancestral properties.....need to address
Attachments: ATT7619186.txt

Thank you for submitting your comments on the Port Authority of Guam's DRAFT Master Plan.

Quoting "Agustin, Rick" <RAgustin@horizonlines.com>:

>
>
> Second submission
> > _____
> > From: Agustin, Rick
> > Sent: Monday, March 03, 2008 2:10 PM
> > To: comments@portofguam.com; Ratnathicam, Nira
> > Cc: glenn
> > Subject: Ancestral properties.....need to address
> >
> > As a private citizen, I am concern that ancestral properties currently
> > held by the port authority of Guam has not been address in the draft
> > master plan. Are the heirs going to be compensated under eminent
> > domain or the properties going to be reverted back to the port and
> > leave the heirs of these valuable land out in the cold and once again
> > denied the use of ancestral lands.
> >
> > A good example is the late Thomas Unsiog. He attended several PAG
> > board meeting and was allowed once to speak about his family property.
> > He waited far too long for the government to make a decision and
> > return this property to the Unsiog Clan.
> >
> > Despite the hard work of Glen Nelson of the port authority, land
> > management and other government agencies did not respond in a timely
> > basis and the Unsiog land never was properly returned to them. Are
> > other property owners going to be in the same predicament?
> >
> > Concern addressed by the writer as a private citizen. Contact number
> > is 888-1928 cell..
> >
> Submitted by:
> Rick (Enrique) Agustin
>
>
> This email and any attachments may contain confidential or privileged
> information. If you have received this email in error, please notify the
> sender by return email and delete immediately without forwarding to others.
>

U.S. Coast Guard

U. S. Coast Guard Sector Guam Comments on PAG Master Plan Draft

1. Pg. 13, Para. E4.4: Cruise Ship Operations. Fully concur with draft MP proposal to relocate cruise ship passenger and vendor access points away from the container operations and outside of the cargo yard security perimeter. This offers significant safety and security benefits, as well as aesthetic advantages for arriving passengers. This approach further offers an opportunity to reduce the inefficient and labor-intensive current practice of establishing and disestablishing a temporary passenger terminal/corridor for each cruise ship arrival.
2. Pg. 15, Para. E5.4: Container Handling. Any container handling and storage scheme that is selected must take into account the heavy weather regularly experienced on Guam. Current PAG and Coast Guard Sector Guam practice is to reduce container stacks to not more than two high at tropical storm/typhoon COR 3. While container stacks of three and even four high may be reasonable, stacking containers higher may result in a mad scramble to find sufficient yard space to lower stacks over a given height in anticipation of heavy weather.
3. Pg. 19, Para. E6.1.4: Ship to Shore Container Cranes. Per conversation with several shipbuilders and container ship operators, I believe reasonable design criteria for PAG container cranes for the next 20 years would be to handle shipboard containers stacked: not more than 9 high; not more than 13 wide. For this reach, 50 foot rail spacing is adequate.
4. Pg. 19, Para. E6.1.5: Cargo Storage yard and Configuration of Terminal Area. Fully concur with the proposal to relocate personnel not directly required for cargo handling operations to a location outside the cargo terminal fence line. This offers the opportunity to enhance security by reducing vulnerabilities associated with the numbers of people and vehicles having direct access to the major vessel berthing locations.
5. Pg. 19, Para. E6.1.5: Concur with relocation of the Fishing Industry Operations and Cruise Ship Industry to a location outside of the cargo terminal fence line. Note, however, that the cruise ship industry requires a level of security precautions far exceeding that of the fishing industry. This may require relocation of or operating restrictions on fishing vessels moored in the port during cruise ship port calls
6. Pg. 19, Para. E6.1.5, Paragraphs 2 and 3: Lighting. Recommend that PAG consider two different lighting systems. One system for night work and one system for security, following established luminosity standards. Two separate lighting systems will allow PAG and tenants to maintain a higher level of light for safe cargo operations at night, as well as a cost-saving lower level of light for security purposes in the absence of cargo operations. Please see the references at the end of these comments.
7. Pg. 19, Para. E6.1.5, Paragraph 2: Concur with the MP recommendation to relocate the existing Shell fuel transfer pipeline located under the container yard. Key utilities and critical infrastructure such as oil product transfer pipelines should be routed outside

any secure or restricted areas to the maximum extent practicable. This reduces vulnerabilities and minimizes cargo handling interferences and interruptions. Also recommend a loop/ring distribution system with appropriate shut offs for electrical power supply, communications, potable water and firefighting water systems for redundancy, flexibility and to minimize opportunities for cargo handling interruptions.

8. Pg. 25, Para. E6.7, Marinas: In view of the current and forecast increasing workload for the PAG Police and the urgent need to take immediate steps to enhance the safety, security and aesthetics of the two PAG-administered marinas, recommend the Government of Guam assign protection of the marinas over to the Guam Police Department. As GPD's Harbor Patrol unit currently resides on Gregorio D. Perez Marina property, an interagency agreement may be feasible.

9. Pg. 27, Para. E6.7.3, Harbor of Refuge: Establishment of a designated area for small vessel haulout and repair, regulated per Guam and federal requirements, would go a long way toward improving the cleanliness and safety of this area and could provide a small source of revenue for GovGuam. The seaplane ramp could serve as one potential site for this service. Fully concur with the proposal in Para. 3 to hold tenants accountable for the cleanliness of the site.

10. Pg. 28, Para. E6.11, Implementing Near-Term Needs: This paragraph identifies the impending military buildup as the primary near-term driver for modernization of the Port. While the cargo volume increases reasonably expected to be associated with the military buildup cannot be discounted, there are other significant reasons to pursue immediate modernization of the Port. PAG has suffered from an unwillingness or inability to recapitalize critical infrastructure, superstructure, equipment and IT systems. PAG must proceed quickly to modernize these systems in order to service container line operators in today's highly competitive shipping environment and to retain its revenue-generating status as the container transshipment hub for Micronesia.

11. Pg. 83, Para. 2.4.6, Fire Protection System: The current GWA/PAG fire protection system is severely lacking in ability to provide long-duration firefighting water. The 2002 Mobil tank fire highlighted this shortfall. The ever-present specter of inadequate firefighting water currently imposes restrictions on PAG and GFD for handling and storage of certain cargoes, such as explosives and oxidizers. Now is the time to design and install an adequate firefighting system. One approach would employ a sprinkler system using potable water for the first 20 minutes and then shifting to a seawater supply. An alternative would be use of a fully seawater supplied system incorporating the ability to be boosted by the mobile pumps to be funded by the FY07 Supplemental Port Security Grant Program.

12. Pg. 91, Para. 2.5.7, Port Security: The PAG Police are resource strapped and would benefit greatly from new equipment to include bulletproof safety vests, a SWAT-like rapid reaction force capability, and communications systems able to interface with other GovGuam and federal law enforcement agencies.

13. Port Security: During several public presentations on the draft Master Plan, PBI presenters stated that PAG failed to comply with the International Maritime Organization's International Ship and Port Facility Security Code. I take issue with this premise. As a United States port subject to the maritime security regulations of Title 33, Code of Federal Regulations, Subchapter H, PAG is subject to and substantially in compliance with the facility security regulations of 33 CFR Part 105. PAG has developed a Facility Security Plan which is spot-checked and exercised. PAG security could benefit from internal security spot-checks and drills overseen by PAG management

14. Pg. 144, Para. 6.6.4.1, Port Security: A high security fence built with materials that will provide a significant useful lifespan in Guam's harsh environment should be installed. The fence should be ten to twelve feet in height with three strands of barbed wire or coiled concertina wire on top. The fence posts should be no more than twelve feet apart. The fence must meet acceptable security standards and have at least a ten-foot clear zone on the outside perimeter. The fence should be protected by traffic barriers to keep vehicles from backing into it and damaging it.

15. Pg. 148, Para. 6.6.4.15, Port Security: Access for emergency responders is addressed in the maritime security regulations.

16. Pg. 148, Para. 6.6.4.16, Port Security: This paragraph recommends stationing K-9 units permanently stationed at the port. Considering the size and resource constraints of the island, this appears to be overkill. Recommend instead that PAG Police, GPD, GIAA Police and TSA develop an interagency MOU for access to an existing K-9 capability on island.

17. Pg. 148, Para. 6.6.6, Port Security: Military and PAG waterfront facilities are separate. I consider it neither necessary nor likely for PAG to be granted direct access to military security monitoring systems.

18. Additional notes:

a. Shell is mentioned as a user of F-1 wharf, but not SPPC (for LPG) or Hanson (for bulk cement).

b. The draft MP makes several references to a water supply tank for firefighting. This option warrants further study. An underground water tank of sufficient capacity could be a great benefit for an installed sprinkler system.

c. Recommend PAG install a loop firefighting water system using seawater to cover the entire port area and tenants.

d. PAG and GFD should collaborate to develop response capability for maritime emergencies within the port. Response personnel should be trained in high-angle heavy rescue, shipboard firefighting, maritime rescue/maritime extrication, and hazmat response.

e. GPD has an underwater surveillance system procured with federal Homeland Security funds. Recommend PAG Police and GPD develop an MOU for scheduled and emergent use of this capability in the port, e.g., security sweeps of the wharves in anticipation of a cruise ship arrival.

f. Arrival of the current Matson Navigation and Horizon Lines container ships in a fully loaded condition (as may occur during the peak of the upcoming military construction boom) will require wharf depths close to the maximum safe depth for F-5 and F-6. The two-stage dredging proposed by PBI may not be feasible or economical if the deeper of the two wharf face depths will be needed within the next 4 years. It would appear that dredging to the maximum depth will be necessary sooner rather than later.

g. Recommend the following regulatory references be used: Title 33, Code of Federal Regulations, Parts 6, 101-106, 126, 127 and 128.