



**INVITATION FOR BID
IFB NO: PAG CIP-018-004**

PROJECT:

**DESIGN BUILD TO SUPPLY AND INSTALL 4ea. 40ft.
GALVANIZED STEEL POLES WITH LED LIGHTING AND 12ea.
ALUMINUM POLES WITH LED SOLAR LIGHTING**

**Port Authority of Guam
1026 Cabras Highway
Piti, Guam 96925**

**Joanne M.S. Brown
General Manager**

MAY 2018



PORT OF GUAM
ATURIDATI PUETTON GUAHAN
Jose D. Leon Guerrero Commercial Port
1026 Cabras Highway, Suite 201, Piti, Guam 96925
Telephone: 671-477-5931/35 Facsimile: 671-477-2689/4445
Website: www.portguam.com



Eddie Baza Calvo
Governor of Guam
Ray Tenorio
Lieutenant Governor

INVITATION FOR BID
IFB No. PAG-CIP-018-004
DESIGN BUILD TO SUPPLY AND INSTALL 4 ea. 40 ft. GALVANIZED STEEL
POLES WITH LED LIGHTING AND 12 EA. ALUMINUM POLES WITH LED SOLAR
LIGHTING

The Port Authority of Guam (PAG), a public corporation and autonomous agency of the Government of Guam, will receive sealed bids for the-

DESIGN BUILD TO SUPPLY AND INSTALL 4EA. 40FT. GALVANIZED STEEL POLES WITH LED
LIGHTING AND 12EA. ALUMINUM POLES WITH LED SOLAR LIGHTING

Bids will be received as described in the bid and contract documents until **2:00p.m. Friday, June 1, 2018 Chamorro Standard Time (Guam Time)**, at the Procurement Office, located at the 2nd Floor of the PAG Administration Building. All bids will be publicly opened and read aloud at the PAG Board of Directors Conference Room. Late bid submittals will not be considered.

All bids must be accompanied by a bid security in the amount of 15% of the total bid price. Bid security may be in a form of a bid bond, certified check or cashier's checks made payable to the PAG. A hard copy or CD of the Invitation for Bid (IFB-PAG-CIP-018-004) may be picked up at the Port's Procurement Office on the 2nd floor of the Administration Building for a \$25.00 fee. All interested bidders must completely fill out the bidder's register and pay fees prior to receiving any copies. Information on this IFB may be posted on the Port's website where maps and drawings can be uploaded.

If you are interested, you may visit our website and download the above Bid online at www.portguam.com or visit our PAG Procurement Division, Jose D. Leon Guerrero Commercial Port 1026 Cabras Highway, Suite 201, Piti, Guam 96925, to pick up a copy. All interested bidders are required to register to ensure that all "Amendments or Special Instructions" are communicated throughout the bid process.

A pre-bid meeting will be held in the PAG Board of Directors Conference Room at **10:00a.m., Chamorro Standard time (Guam Time), Friday, May 25, 2018** and a site tour of the proposed project location will be held immediately after the pre-bid meeting, all prospective bidders are encouraged to attend.

The PAG reserves the right to reject any and all bids and to waive any and all informalities, and to disregard all nonconforming or conditional bids or counter proposals when in PAG's opinion, such rejection or waiver will be in the Authority's best interest.

For additional information, contact Mr. Mark A. Cabrera, Buyer II at (671) 477-5931 ext. 454 or email at: macabrera@portguam.com.

JOANNE M.S. BROWN
General Manager

VOLUME 1
GENERAL INFORMATION AND INSTRUCTIONS
TO BIDDERS

GENERAL INFORMATION

I. INTRODUCTION

The Jose D. Leon Guerrero Commercial Port or Port Authority of Guam (PAG), hereinafter referred to as PAG, is inviting firms to participate in the Invitation for Bid (IFB), for the DESIGN BUILD TO SUPPLY AN INSTALL HOT DIPPED GALVANIZED STEEL POLES WITH LED LIGHTING AND ALUMINUM POLES WITH SOLAR LIGHTING FIXTURES AT THE PORT'S VARIOUS LOCATIONS.

PROJECT DESCRIPTION:

This is a design build project to supply and install new 4 each 40 ft. hot dipped galvanized steel pole with LED lighting and 10 ea. 20 ft. aluminum pole with solar lighting fixtures at ports various locations.

All system shall meet the standard compliance of organizations for the American National Standard Institute (ANSI), American Society for Testing & Materials (ASTM), Underwriter Laboratories (UL), national electrical Manufacturers Association (NEMA), National Electrical Code (NEC), and Occupational Safety & Health Association (OSHA).

II. INSTRUCTIONS TO BIDDERS:

These instructions to bidders are intended to provide guidance in the preparation of bid proposals. Please note that the act of submitting a bid to this IFB, constitutes an acceptance on the part of the Bidder that they have read each and every provision; and thus, agree to all terms and conditions contained within this bid, as well as, that they have read and understand all of the bid documents, including all information contained within the appendices.

1. RECEIPT OF BID OFFERS

Bids will be received at the Procurement and Supply Division, 2nd Floor of the Port Authority of Guam (PAG) Administration Building, **no later than 2:00 P.M. Chamorro Standard Time (Guam Time), Friday, June 1, 2018** for the installation of metal poles and fixtures that include led and solar lighting. In response to this Invitation for Bid (IFB), interested parties shall submit bids in the format described in these bid documents and shall be addressed to the General Manager, Port Authority of Guam, 1026 Cabras Highway, Suite 201, Piti, Guam 96925.

Two (2) copies, one (1) original, and one (1) CD containing electronic file copy (in PDF format) of the complete bid proposal shall be enclosed in a sealed package or envelope, clearly labeled on the outside as "**Invitation for Bid-**". The package or envelope must be clearly labeled with the name of the Bidder.

All bid proposals submitted after the time and date set for receipt as indicated above, shall be considered late bids and will not be considered. Late bids will be returned "un-opened" to the bidder. Attention is called to the fact that bidders not only offer to assume the obligations and liabilities imposed upon the Contractor in the form of contract, but expressly make certain of the representations and warrants made therein. No effort is

made to emphasize any particular provision of the contract, but bidders must familiarize themselves with every provision of the contract and its effect.

2. **PRE-BID CONFERENCE, INQUIRIES, AND COMMUNICATIONS**

A pre-bid conference is scheduled on **Friday, May 25, 2018, at 10:00 a.m.** Chamorro Standard Time (Guam Time) at the PAG Board of Directors' Conference Room and a **site tour will be scheduled immediately after.** All prospective bidders are encouraged to attend. Identification to enter the Port compound will be required 24 hours prior to the site visit, meaning it must be submitted no later than **10:00 a.m. May 24, 2018.** Please bring your hard hat, safety vest, closed toed shoes, and measuring tools as the Port will not provide it.

All Requests for Information (RFI) (inquiries, clarifications or questions) must be submitted in writing no later than **4:00 p.m., Monday, May 28, 2018.** RFI shall be submitted to the attention of the PAG General Manager and may be sent via facsimile to 472-1439 or emailed to Mark Cabrera- Buyer II, at macabrera@portguam.com. The Port will respond in writing to all written inquiries and/or clarifications via an addendum to this IFB. All formal communications shall be issued through the addendum process only and shall be distributed to all recognized document holders.

Prohibited Communication: Bidders shall conduct themselves with professional integrity and refrain from lobbying activities. During the procurement process (commencing with the issuance of this IFB and continuing until execution of a contract resulting from this solicitation or cancellation of the procurement), no employee, member, agent, advisor, or consultant of any Bidder shall have any communications, directly or indirectly, regarding this procurement with any representative of the Port, including their staff, advisors, contractors, or consultants involved with the procurement, except for communications expressly permitted by this IFB to the attention of the General Manager or the Procurement and Supply Manager. Any verified allegation that the Bidder or an employee, agent, advisor, consultant, or subcontractor of the Bidder engaged in such prohibited communications or attempted to unduly influence any part of the solicitation may be cause for Port to disqualify the Bidder from participating at the discretion of the Port.

Oral explanations or instructions should not be given, but if any are inadvertently or improperly given, no oral representations by any representative of PAG will be binding and any action taken by the Bidder based upon such oral advice or clarification will be at the sole risk of the Bidder.

3. **IFB DOCUMENTS**

IFB Documents or Electronic Copies of the IFB are available at no charge and can be obtained at the Procurement & Supply Office on the 2nd floor of the Port Authority of Guam, Administration Building located at 1026 Cabras Highway, Suite 201, Piti, Guam 96925.

The IFB Documents are organized into five separate volumes, as follows:

Volume 1 - General Information/Instruction to Bidders

Volume 2	-	Special Provisions and General Conditions
Volume 3	-	Required Forms and Affidavits
Volume 4	-	Sample Construction Agreement Performance and Payment Bond Form
Volume 5	-	Specifications and Drawings

4. **MODIFICATIONS AND SOLICITATION AMENDMENT**

Any amendment, modification or addendum issued by the PAG prior to the opening of the bids, for the purpose of changing the bid requirements, clarifying the meaning or changing any of the provisions of this IFB, shall be binding to the same extent as if written in the bid documents and will be deemed incorporated into the contract or not.

The PAG reserves the right to amend, supplement, cancel and/or reissue this bid in whole or in part at any time, when this action serves the best interest of the PAG. Any modification that are of a nature which requires material changes in quantities or prices to be bid or both, the date set for opening bids may be postponed by such number of days as in the opinion of the issuing officer. In such cases, the addendum will include an announcement of the new date for opening proposals/bids. Such revisions, if any, will be announced by an addendum or addenda to this invitation for bid and bidders shall acknowledge receipt of such addenda by signature, which is to be returned to the Procurement and Supply Office by fax or by email. Failure to acknowledge receipt of any addenda will result in rejection of bidders' proposal/bid.

5. **FAMILIARITY WITH LAWS**

The bidder shall be familiar with all Federal (U.S.) and local laws, ordinances, rules and regulations of Guam that in any manner affect the work. Ignorance of law or on the part of the bidder will not relieve the bidder from responsibility.

6. **PREPARATION AND SUBMISSION OF BID**

The bidder must submit his bid on the forms furnished by the PAG. All blank spaces in the bid forms must be correctly filled in where indicated and the bidder must state the prices (both in words and numerals) for which he proposes to do each item of the work contemplated or furnish each item of the materials required. In case of conflict between words and numerals, the words, unless obviously incorrect, will govern. Erasures or other changes in a bid must be explained or noted over the signature of the bidder. Bids containing any conditions, omissions, unexplained erasures or alterations or items not called for in the proposal or irregularities of any kind may be rejected by the PAG as being incomplete.

All bids must give the full business address of the bidder and be signed by him with his usual signature. Bids by partnerships must furnish the full names of all partners and must be signed in the name of the partnership by one of the members of the partnership or by an authorized representative followed by the signature and designation of the person signing. Bids by corporations must be signed with the legal name of the corporation, followed by the name of the State of incorporation and by the signature and designation of

the president, secretary, or other person authorized to bind it in the matter. The name of each person signing shall also be typed or printed below the signature. A bid by a person who affixes to his signature the word "president", (agent or other designation, without disclosing his principal), may be held to the bid of the individual signing. When requested by the Owner, satisfactory evidence of the authority of the officer signing in behalf of the corporation shall be furnished.

The PAG is not liable for any costs incurred by the bidder in connection with the preparation of this solicitation. By submitting a bid, the bidder specifically waives the right against the PAG for any expenses incurred in his bid preparation. Submitted bids become the property of the PAG. Bidder's request for the return of specific proprietary materials may be honored.

7. TRADE SECRETS AND PROPRIETARY DATA

Bidders may request to have certain portions of their bid submittals designated as trade secrets or proprietary data. PAG will examine such request to determine the validity of any requests for nondisclosure of trade secrets and other proprietary data identified in the request. If the PAG and bidder are unable to agree as to the disclosure of certain portions of the bidder's bid will be disclosed and that, unless the bidder withdraw its bid or protests under 5 GCA Article 9 (Legal and Contractual Remedies) of the Guam Procurement Act, the information may be so disclosed. The bids shall be opened to public inspections subject to any continuing prohibition on the confidential data.

8. WITHDRAWAL OF BIDS

Bids may be withdrawn on written or telegraphic request received from bidders prior to the time and date set for bid opening. Negligence on the part of the bidder in preparing the bid confers no right to the withdrawal of the bid after it has been opened.

9. BID SECURITY, PERFORMANCE, AND PAYMENT BOND

Each bid must be accompanied by a deposit in the amount of not less than fifteen percent (15%) of the highest bid price for which award can be made. Such deposit may be in the form of a bid bond, cashier's check, or certified check made payable to the Port Authority of Guam. Should the successful bidder fail or refuse to execute and deliver the contract and performance and payment bonds required within ten (10) working days after acceptance of his bid by the Government, he shall forfeit to the Government of Guam as liquidated damages for such failure or refusal, the security deposited with his bid.

10. BUSINESS LICENSES

Bidders are reminded that all firms proposing and/or bidding on Government of Guam contracts must be fully licensed to do business in Guam at the time of submission of bids. Bidders must submit a copy of a current Contractor's License for constructions services issued by the Guam Contractor's License Board in conformance with Public Law 14-51. Failure to submit a conforming Contractor's License shall result in the bid being declared non-responsive, whereby bid will be rejected.

Additionally, professional services firms as sub-consultants of Prime Bidder, are required to have a Certificate of Authorization (COA) through the Board of Professional Engineers, Architects, and Land Surveyors, Guam (PEALS) at the time of submission of bids.

11. RIGHT TO ACCEPT AND REJECT BIDS

The PAG reserves the unqualified right, in its sole and absolute discretion, to reject any and all bids, or to accept that bid or combination of bids, if any, or waive informalities and minor irregularities in the bids, including the sole right to determine what constitutes irregularities in the bids which in its sole and absolute judgment will under all circumstances best serve the Government's interests. In the event that the successful bidder fails to execute the contract upon his part or to furnish a satisfactory performance and payment bond, the Government, after declaring forfeited the security deposit of such bidder, reserves the option to accept the bid of any other bidder within ten (10) calendar days from such default, in which case such acceptance shall have the same effect as to such bidder as though he was the original successful bidder.

12. METHOD OF AWARD

Pursuant to 5 GCA §5211(g) of the Guam Procurement Act, the contract is to be awarded to the **lowest responsive, responsible bidder whose bid meets the requirements and criteria set forth in this Invitation for Bid.**

The award shall be made in accordance to the following conditions:

Bidding procedure involving only a basic bid: If the total of the basic bid items is within the amount of funds available to finance the project, then contract award will be made to that bidder submitting the lowest responsive and responsible basic bid.

The Government estimate will be recorded prior to bid opening and announcement will be made after all bids are opened.

13. COMPETENCY OF BIDDERS

The Port will require bidders to present satisfactory evidence that he has sufficient experience and past performance and is fully prepared with the necessary capital, material, machinery, and skilled workmen and supervisory staff to carry out the contract satisfactorily. The information is required for the Prime Contractor and each subcontractor, if any.

The purpose of this requirement is to provide the Port with a basis for determining the Prime Contractor and its subcontractors' financial and technical capability for undertaking this project which shall deem the Bidder as responsive and responsible. The Port is not interested in a voluminous description of all prior contracts undertaken, but rather a concise, thorough description of past experience relevant to this project.

Accordingly, in the Port's determination of a responsive and responsible bidder, the Contractor and its sub-contractors must submit for review the following documents and statements:

- a) Organizational Structure identifying the Prime Contractor and all its sub-contractors
- b) Experience of key staff or firm on similar work.
- c) Past performance of firm or key (to be assigned to this project) staff in accomplishing government projects or other client projects of this nature in the agreed time. Bidders and its sub-contractors must include a listing of past performances of key personnel with similar projects;
- d) Availability of plant, machinery and other equipment necessary for work.
- e) References who can attest to the quality of work on past or ongoing projects being performed for Local and Federal Government and other organizations/clients.
- f) References who can attest to Contractor's diligence in carrying out responsibility.
- g) References who can attest to, or documents that can illustrate, record of good Owner-Contractor relationship.
- h) Statement about previous record of bids qualification, for example: no loss of bid bonds and/or no rejections following responsibility checks.
- i) Record of past performance of government contracts including record of default and nonpayment of obligations.
- j) Possession of Government of Guam appropriate contractor's license

Any bidder, who at the time of bidding has been determined by the PAG or the Dept. of Public Works to be liable to pay liquidated damages for delay in completion of the last two projects contracted with any Government of Guam projects, will be automatically rejected.

III. COMPLIANCE WITH LAWS AND MANDATORY FORMS FOR SUBMITTAL

1. DISCLOSURE OF MAJOR SHAREHOLDERS:

As a condition of bidding, any partnership, sole proprietorship or corporation doing business with the Port Authority of Guam shall submit an affidavit executed under oath that lists the name and address of any person who has held more than ten percent (10%) of the outstanding interest or shares in said partnership, sole proprietorship or corporation at any time during the twelve (12)-month period immediately preceding submission of a bid. The affidavit shall contain the number of shares or the percentage of all assets of such partnership, sole proprietorship or corporation which have been held by each such person during the twelve (12)-month period. In addition, the affidavit shall contain the name and address of any person who has received or who is or may become entitled to receive a commission, gratuity or other compensation for procuring or assisting in obtaining business related to the bid for the bidder and shall also contain the amounts of any such actual or potential commission, gratuity or other compensation. The affidavit shall be open and available to the public for inspection and copying. Failure by any bidder to submit the **Affidavit Disclosing Ownership and Commissions - AG Form 002**, shall result in the disqualification of his bid

2. NON-COLLUSION AFFIDAVIT

Each person submitting a bid for any portion of the work covered by the bid documents shall execute an affidavit, in the form provided with the bid, to the effect that he has not colluded with any other person, firm or corporation in regards to any bid submitted. Such affidavit shall be attached to the bid. Failure by any bidder to submit the **Affidavit Re Non-Collusion - AG Form 003**, shall result in the disqualification of his bid.

3. **REPRESENTATION REGARDING GRATUITIES AND KICKBACKS**

The bidder, offeror or contractor represents that it has not violated, is not violating, and promises that it will not violate the prohibition against gratuities and kickbacks set forth in 2 GAR, Div. 4, §11107, 5 GCA §5631 (a) and 2 GAR, Div. 4, §11108 of the Guam Procurement Regulations. Failure by any bidder to submit the **Affidavit Re No Gratuities or Kickbacks- AG Form 004**, shall result in the disqualification of his bid.

4. **REPRESENTATION REGARDING ETHICAL STANDARDS FOR GOVERNMENT EMPLOYEES AND FORMER GOVERNMENT EMPLOYEES**

The bidder, offeror or contractor represents that it has not knowingly influenced and promises that it will not knowingly influence a government employee to breach any of the ethical standards set forth in 5 GCA, §5601 *et.seq.* (Ethics in Public Contracting) of the Guam Procurement Act. Failure by any bidder to submit the **Affidavit Re Ethical Standards - AG Form 005**, shall result in the disqualification of his bid.

5. **COMPLIANCE WITH WAGE LAWS**

The bidder who is awarded a contract shall pay employees, at a minimum, in accordance with the Wage Determination for Guam and the Northern Mariana Islands issued and promulgated by the U.S. Department of Labor for such labor as is employed in the direct delivery of contract deliverables to the Port. In the event of a renewal of a contract, the Wage Determination promulgated by the U.S. Department of Labor on a date most recent to the renewal date of the contract shall apply to that renewal contract. In addition to the applicable Wage Determination, the contract shall contain provisions mandating health and similar benefits for employees, such benefits having a minimum value as detailed in the Wage Determination promulgated by the U.S. Department of Labor, and shall contain provision guaranteeing a minimum of ten (10) paid holidays per annum for each employee.

The bidder is required to execute and submit the **Declaration Re Compliance with U.S. DOL Wage Determination- AG Form 006**. Failure to submit such form shall result in the disqualification of his bid.

6. **PROHIBITION AGAINST CONTINGENT FEES**

The bidder, offeror or contractor represents that it has not retained a person to solicit or secure a territorial contract upon an agreement or understanding for a commission, percentage, brokerage, or contingent fee, except for retention of bona fide employees or bona fide established commercial selling agencies for the purpose of securing business. Failure by any bidder to submit the **Affidavit Re Contingent Fees - AG Form 007**, shall result in the disqualification of his bid.

7. **POLICY IN FAVOR OF LOCAL PROCUREMENT**

Procurements of supplies and services shall, where possible, be made from among

businesses licensed to do business on Guam and that maintain an office or other facility on Guam. The bidder, offeror or contractor is encouraged to favor local procurement standards set forth in 5 GCA, §5008 and 2 GAR, Div. 4, §1104.

8. **PRODUCTS MANUFACTURED FROM RECYCLED GLASS**

Pursuant to Title 5, GCA Section 5218, any individual or company submitting a response to this solicitation shall include the purchase of available recycled glass pulverized on Guam or appropriate products manufactured therein. The contract awarded under this solicitation shall determine the suitable percentage of recycled glass to be used on the project and, as a condition of the contract award, shall require the Contractor to identify and certify in writing the percentage of recycled glass contained in the material offered.

9. **APPRENTICE TRAINING PROGRAM**

Pursuant to Executive Order No. 2000-10, the contractor shall employ at least one (1) apprentice for every ten (10) workers for the duration of the project, and not less than one (1) apprentice per project. This requirement may be waived only if the Department of Public Works and the Guam Community College both certify that no apprentice is available.

The Executive Order applies to all public works construction projects such as the erection, maintenance, rehabilitation, repair, or demolition of any public building, roadway, or any public facility as defined in §50106 of Title 5, GCA, and applies to all departments and agencies within the government of Guam. It also applies only to projects over One Hundred Thousand Dollars (\$100,000.00).

The Director of the Department of Public Works shall monitor the compliance with this Executive Order and enforce and exercise authority to achieve the objectives of the Executive Order and shall report to the Guam Community College on a quarterly basis, the impact of this program.

The Guam Department of Labor shall inform all employers applying for H-2 alien labor certification that to qualify for government of Guam construction projects, all conditions of Executive Order No. 2000-10 shall be met.

10. **Restriction Against Contractors Employing Convicted Sex Offenders from Working at Government of Guam Venues.** (Subsection 5253 of Title 5 Guam Code Annotated)

a. No person convicted of a sex offense under the provisions of Chapter 25 of Title 9 Guam Code Annotated, or an offense as defined in Article 2 of Chapter 28, Title 9 GCA in Guam, or an offense in any jurisdiction which includes, at a minimum, all of the elements of said offenses, or who is listed on the Sex Offender Registry, and who is employed by a business contracted to perform services for an agency or instrumentality of the government of Guam, shall work for his employer on the property of the government of Guam other than a public highway.

b. All contracts for services to agencies listed herein shall include the following provisions: (1) warranties that no person providing services on behalf of the contractor

has been convicted of a sex offense under the provisions of Chapter 25 of Title 9 of GCA or an offense as defined in Article 2 of Chapter 28, Title 9 GCA, or an offense in another jurisdiction with, at a minimum, the same elements as such offenses, or who is listed on the Sex Offender Registry; and (2) that if any person providing services on behalf of the contractor is convicted of a sex offense under the provisions of Chapter 25 of Title 9 GCA or an offense as defined in Article 2 of Chapter 28, Title 9 GCA or an offense in another jurisdiction with, at a minimum, the same elements as such offenses, or is listed on the Sex Offender Registry, that such person will be immediately removed from working at said agency and that the administrator of said agency be informed of such within twenty-four (24) hours of such conviction.

- c. Duties of the General Services Agency or Procurement Administrators. All contracts, bids, or Request for Proposals shall state all the conditions in §5253(b).
- d. Any contractor found in violation of §5253(b), after notice from the contracting authority of such violation, shall, within twenty-four (24) hours, take corrective action and shall report such action to the contracting authority. Failure to take corrective action within the stipulated period may result in the temporary suspension of the contract at the discretion of the contracting authority.
- e. Subject to the provisions of 12 GCA §10402 (Public Law 29-23), the contract will contain performance reviews at least annually, and provisions for contract termination and penalty based upon such review.

11. DOCUMENTS EXECUTED OUTSIDE GUAM

The Power of Attorney, affidavits, bonds, and/or any documents defining the constitution of the joint venture, consortium, company or firm, if executed outside Guam, whether required to be submitted with the proposals or upon award of the contract, must be authenticated by a Notary Public or other official duly authorized by law in the jurisdiction where they are authorized to witness sworn statements.

12. EQUAL EMPLOYMENT OPPORTUNITY

Discrimination in all phases of contracted employment, consultant activities, contracting activities, and training is prohibited by Title VI of the Civil Rights Act of 1964, Section 162(a) of the Federal-Aid Highway Act of 1973, Section 504 of the Rehabilitation Act of 1973, the Age Discrimination Act of 1975, the Justice System Improvement Act of 1979, the Americans with Disabilities Act of 1990, the Civil Rights Restoration Act of 1987, 49 CFR Part 21, and other related laws and statutes. The referenced legal citations establish the minimum requirement for affirmative action efforts and define the basic non-discrimination provisions as required by this IFB. Bidders are required to comply with all the requirements regarding equal employment opportunity policies at all contracting levels of this IFB.

***** END OF GENERAL INFORMATION *****

VOLUME 2
SPECIAL PROVISIONS AND GENERAL CONDITIONS

SPECIAL PROVISIONS

1. **General Intention:**

It is the declared intention and meaning to provide and secure all necessary labor, materials, equipment, tools and services necessary for the delivery and completion of the project identified in the bid documents and specifications provided herein.

2. **Bid:**

The Contractor and each and every subcontractor shall read the General Conditions immediately following these special provisions, and by the act of submitting a bid, shall be deemed to have accepted all conditions contained therein.

3. **Specifications and Standards:**

The specifications and standards referenced in this specification (including addenda, amendments and errata listed) shall govern in all cases where the references thereto are made. In case of difference between the referenced specifications or standards and this specification or its accompanying drawings, this specification and its accompanying drawings shall govern to the extent of such difference, otherwise the referenced specifications and standards shall apply. Extra care shall be exercised to refer in requests for quotations in orders and in subcontracts to the referenced specifications and to all modifications thereof.

4. **Time for Completion:**

It is hereby understood and mutually agreed, by and between the Contractor and the Port Authority of Guam, that the date of beginning the project, rate of progress and the time for completion of the work to be done hereunder are essential conditions of this contract; and it is further mutually understood and agreed that the work embraced in this contract shall be commenced on a date to be specified in the Notice to Proceed and shall be completed within the specified date in the Notice to Proceed, unless otherwise adjusted by mutual agreement and corresponding contract modification.

5. **Liquidated Damages:**

It is hereby understood and mutually agreed by and between the Contractor and the Port Authority of Guam that liquidated damages shall be assessed for each calendar day the work remains incomplete after the days from the effective date set forth in the Notice to Proceed.

If the said Contractor shall neglect, fail or refuse to complete the work within the time herein specified, the Contractor does hereby agree, as part of the consideration for the awarding of this contract, to pay to the Port Authority of Guam the **amount of \$1,000.00** per calendar day, not as a penalty but as liquidated damages for such breach of contract as hereinafter set forth, for each and every calendar day that the Contractor shall be in default of the time stipulated in the contract for completing the work.

The said amount is fixed and agreed upon by and between the Contractor and the Port Authority of Guam because of the impracticability and extreme difficulty of fixing and ascertaining the actual damages the Port Authority of Guam would in such event sustain, and said amounts shall be retained from time to time by the Port Authority of Guam from current periodical estimates.

It is further agreed that time is of the essence of each and every portion of this contract, and of the specifications wherein a definite and certain length of time is fixed for the performance of any act whatsoever; and where under the contract an additional time is allowed for the completion of any work, the new time limit fixed by such extension shall be of the essence of this contract. Provided, that the Contractor shall not be charged with liquidated damages of any excess cost when the delay in completion of the work is due

- a) to any preference, priority or allocation order duly issued by the Port Authority of Guam.
- b) to unforeseeable causes beyond the control and without the fault or negligence of the Contractor, including but not restricted to acts of God or the public enemy, acts of the Port Authority of Guam, acts or another Contractor in the performance of a contract with the Port Authority of Guam, fires, floods, epidemics, quarantine restrictions, strikes, freight embargoes, and unusually severe weather; and
- c) to any delays of Subcontractors or suppliers occasioned by any of the causes specified in subsections (a) and (b) of this article.

Provided further that the Contractor shall, within seven (7) calendar days from the beginning of delay, give written notice as to the causes of the delay to the Contracting Officer, who will ascertain the facts and extent of the delay and notify the Contractor within reasonable time of his decision in the matter.

Contractor must note that Guam by nature has frequent rainfall causing suspension of work. Said suspensions shall not qualify for time extensions unless the weather is unusually severe.

6. Disposal:

Unsuitable materials as a result of contractor's operations shall be disposed of in accordance with the local laws and/or policies of concerned agencies. Disposal, tipping fees/charges shall be at the contractor's expense.

The Contractor shall investigate the project site prior to bidding and verify existing conditions/ dimensions. Upon failure to do so any changes due to conditions/dimensions not reflected in the plans will be done at the Contractor's expense.

The Contractor shall submit technical brochures, samples, shop drawings and details as required by the Project Specifications prior to purchase or installation.

7. Material Standards:

All material and equipment must conform to applicable standards of organizations such as

the American National Standard Institute (ANSI), the American Society for Testing and Materials (ASTM), the National Manufacturers Association (NEMA), and the Underwriters Laboratories (UL). Proof of such conformance shall be submitted to the Engineer for approval. References to various standards contained in the specification and drawings shall be understood to be the issue or revision in effect on the date of such deviation shall be detailed in a written request to the Port Authority of Guam for approval and shall not be initiated until written approval is received by the Contractor from the Port Authority of Guam.

8. Contractor Furnished Equipment:

All materials and equipment required to complete the project shall be furnished by the Contractor.

9. Owner Furnished Materials:

If materials are provided by the Port Authority of Guam, the Contractor shall be responsible to transport these items from their current locations to the job site.

a) The Contractor shall repair or replace these items if damaged during transport to the site. In addition, the Contractor shall repair any damage to public and private property caused by the transport of these items.

b) All materials and equipment if furnished by the Port Authority of Guam are in good condition. Prior to the start of construction, the Contractor shall inspect these items and acknowledge the receipt thereof. The Contractor is responsible for repairing and replacing any damage or theft of equipment or damage which causes the equipment to be inoperable from the date it was received and prior to final acceptance of this project. All expenses shall be the Contractor's responsibility.

10. Underground Utilities Clearances if Applicable:

a) The Contractor shall secure all permits required for construction including permits by the Department of Public Works, U.S. Navy, and other agencies involved.

b) The Contractor shall coordinate with the government and private utility agencies in obtaining clearances prior to excavation. Extra care shall be taken so as not to damage any existing underground utilities. Any damaged utilities and any effects of the damage shall be the Contractor's responsibility.

11. Surplus Materials:

Existing materials removed shall be cleaned, disassembled and assured to be in good condition before transporting the materials to the locations designated by the Contracting Officer. Materials returned shall be signed for receipt given. The Contractor shall be responsible for proper accounting of all returned materials. Any difference between the credit receipts and removal quantities, as determined by the Contracting Officer, shall be the Contractor's financial responsibility. The difference shall be deducted from the total value of the Contract at the end of the project. Unsalvageable, rotten or junk materials, must be certified by the Port Authority's Inspector in writing, and shall be properly disposed of at an approved disposal location at the sole financial responsibility of the Contractor

*****END OF SPECIAL PROVISIONS*****

GENERAL CONDITIONS

I. DEFINITIONS

1. **Owner**
The term "Owner" as used herein means the Port Authority of Guam, Cabras, Piti and shall include the Governor of Guam, and/or his authorized representatives.

2. **Contracting Officer**
The term "Contracting Officer" as used herein means the General Manager of the Port Authority of Guam and shall include his authorized representatives.

3. **Engineer**
The term "Engineer" as used herein means the Port Authority's Manager of CIP/Engineering and shall include his authorized representatives.

4. **Contractor**
The term "Contractor" as used herein means the party or parties who or which shall have duly entered into a contract with the Port Authority of Guam to perform the work herein contemplated or his or their authorized assignee.

5. **Notice**
The term "Notice" as used herein shall mean and include all written notice demands, instructions, claims, approvals and disapprovals required to obtain compliance with contract requirements. Any written notice by either party to the contract shall be sufficiently given if delivered to or at the last known business address of the person, firm, or corporation constituting the other party to the contract, or to his, their, or its duly authorized agent, representative, or officers, or when enclosed in a postage prepaid envelope addressed to such last known business address and deposited in a United States mail box. The Contractor must provide and maintain a post office address within Guam and file the same with the Contracting Officer.

6. **Forms Enclosed**
The copies of the Formal Contract and Bid Bond, enclosed herewith are incorporated in these General Conditions by reference and are made a part hereof to the same extent as though fully set forth herein.

II. CONSTRUCTION CONTRACT

1. **Contract Documents**
 - a) The contract documents consist of the Formal Contract, the Technical Specifications, and Plans (Drawings) including all addenda and alterations made in the documents prior to their execution.

- b) The contract documents shall be signed by the Owner and Contractor in as many original counterparts as may be mutually agreed upon.
- c) Anything required by one of the contract documents shall be of like effect as if required by all the contract documents whether the other contract documents have the same requirement or not. In case of conflict between the contract documents, the technical specifications shall take precedence over the plans, and the Formal Contract shall be controlling over the plans and technical specifications. Any discrepancies between the Contract documents shall be called to the attention of the Contracting Officer before proceeding with work affected thereby.
- d) It will be conclusively presumed that the Contractor has read, examined and agreed to each and every term, conditions, provisions, covenant or agreement in the plans (drawings), technical specifications, bid forms, contract, and conditions related to the work to be carried on, said documents being on file in the Procurement Office, Port Authority of Guam; 1026 Cabras Hwy., Suite 201; Piti, Guam.

2. Drawings

- a) In case of differences between small scale and large scale drawings, the large scale drawings shall govern. Figured dimensions on the drawings shall be considered primary compared with measurements obtained through scaling of drawings. The Contractor shall verify all dimensions, and if any may be lacking, he shall call the attention thereto and be governed by the decision of the Contracting Officer.
- b) Where the word "similar" occurs on the drawings, it shall be interpreted in its general sense and not as meaning identical.
- c) The approval of shop and setting drawings will be general and shall not be construed (1) as permitting any departure from the contract requirements, (2) as relieving the Contractor of the responsibility for any error in details, dimensions and otherwise that may exist; (3) as approving departures from additional details or instructions previously furnished by the Contracting Officer.
- d) The Contractor will be furnished additional instructions and detail drawings as may be necessary to carry out the work included in the contract. The additional drawings and instructions thus supplied to the Contractor shall be consistent with the contract documents and true developments thereof, and shall be so prepared that they can be reasonably interpreted as a part thereof. The Contractor shall carry out the work in accordance with the additional detail drawings and instructions.

3. Contract Change Orders

- a) The Contracting Officer at any time, without notice to the sureties may, by

written order designated or indicated to be a change order, may make any change in the work within the general scope of the contract, including but not limited to changes:

- (1) In the specifications (including drawings and designs);
 - (2) In the method or manner of performance of the work;
 - (3) In the Government-furnished facilities, equipment, materials, services for site; or
 - (4) Directing acceleration in the performance of the work.
- b) Any other written order (which terms as used in this paragraph (b) shall include direction, instructions, interpretations or determination from the Contracting Officer) which causes any such change, shall be treated as a change order under this clause, provided that the Contractor gives the Contracting Officer written notice stating the date, circumstances and source of the order and that the Contractor regards the order as a change order.
- c) Except as herein provided, no order, statement, or conduct of the Contracting Officer shall be treated as a change order under this clause or entitle the Contractor to an equitable adjustment hereunder.
- d) If any change under this clause causes an increase or decrease in the Contractor's cost of, or the time required for the performance of any part of the work under this contract, whether or not changed by any order, an equitable adjustment shall be made and the contract modified in writing accordingly, provided, however, that except for claims based on defective specifications no claim for any change under (b) above shall be allowed for any costs incurred more than 20 calendar days before the Contractor gives written notice as therein required. And provided further, that in the case of defective specifications for which the Owner is responsible, the equitable adjustment shall include any increased cost reasonably incurred by the Contractor in attempting to comply with such defective specifications.
- e) If the Contractor intends to assert a claim for an equitable adjustment under this clause, he must, within 30 calendar days after receipt of a written change order under (a) above or the furnishing of a written notice under (b) above, submit to the Contracting Officer a written statement setting forth the general nature and monetary extent of such claim, unless this period is extended by the Owner. The statement of claim hereunder may be included in the notice under (b) above.
- f) No claim by the Contractor for an equitable adjustment hereunder shall be allowed if asserted after final payment under this contract.

4. Specifications and Drawings

- a) The Contractor shall keep on the work site a copy of the drawings and

specifications including all authorized change orders, and shall at all times give the Owner, Contracting Officer and their representatives access thereto.

- b) All drawings and specifications and copies thereof furnished by the Contracting Officer are his property and shall not be used on other projects without his consent. Upon completion of this project all copies of the drawings and specifications except the signed contract sets are to be returned to the Contracting Officer upon his request.

5. Special Requirements

Where special requirements, provisions or specifications or detailed specifications are attached hereto or are included in the proposal they shall be considered a part of these general conditions or specifications or detailed specifications as fully as if contained herein. Should any special provisions be in conflict with these general conditions or specifications or detailed specifications, said special requirements, provisions or detailed specifications shall govern.

6. Explanation to Bidders

No oral explanation in regard to the meaning of the drawings and specifications will be made and no verbal instructions will be given before the award of the contract. Discrepancies, omissions, or doubts as to the meaning of bid submittal documents, contract provisions, drawings and technical specifications should be communicated in writing to the Contracting Officer for interpretation. Bidders should act promptly and allow sufficient time for a reply to reach them. Every interpretation made to a bidder will be in the form of an addendum to the Invitation for Bids documents which, if issued, will be sent as promptly as practicable to all persons to whom the bid documents have been issued. All such addenda shall become part of the contract documents.

III. BIDS, BIDDER RESPONSIBILITIES

1. Conditions at Site or Building

(a) Bidders should visit the site and shall be responsible for having ascertained pertinent conditions such as location, accessibility, and general character of the site or building, the character and extent of existing work within or adjacent to the site, and any other work being performed thereon at the time of the submission of their bids. No extra compensation will be made by reason of any misunderstanding or error as regards to the site, the conditions thereof, accessibility or the amount of kind of work to be performed.

(b) If, in the performance of the contract, subsurface or latent conditions at the site are found to be materially different from those indicated by the drawings and specifications, or unknown conditions of an unusual nature are disclosed differing materially from the conditions usually inherent in work of the character shown and specified, the attention of the Contracting Officer shall be called immediately to such conditions before they are disturbed.

Upon such notice, or upon his own observation of such conditions, the Contracting Officer shall promptly make such changes in the drawings and specifications as he finds necessary to conform to the different conditions, and any increase or decrease in the cost of the work resulting from such changes shall be adjusted as provided under Changes in Work.

2. Submission of Bids

- (a) The bidder is required to bid on all items called for in the Bid Form.
- (b) Bids shall be submitted on the forms furnished or copies thereof, and shall be signed in ink. Erasures or other changes in a bid must be explained or noted over the signature of the bidder. Bids containing any conditions, omissions, unexplained erasures or alterations or items not called for in the proposal or irregularities of any kind may be rejected by the Owner as being incomplete.
- (c) Each bid must give the full business address of the bidder and be signed by him with his usual signature. Bids by partnerships must furnish the full names of all partners and must be signed in the name of the partnership by one of the members of the partnership or by an authorized representative followed by the signature and designation of the person signing. Bids by corporations must be signed with the legal name of the corporation, followed by the name of the State of incorporation and by the signature and designation of the president, secretary, or other person authorized to bind it in the matter. The name of each person signing shall also be typed or printed below the signature. A bid by a person who affixes to his signature the word "president", (agent or other designation, without disclosing his principal), may be held to the bid of the individual signing. When requested by the Owner, satisfactory evidence of the authority of the officer signing in behalf of the corporation shall be furnished.

3. Bid Guarantee

Bids shall be accompanied by a bid guarantee of not less than fifteen percent (15%) of the total bid amount for which an award can be made. Bid guarantee may be bid bond (form enclosed), certified check or cashier's check. Bid bond shall be signed by the bidder, two major officers of the Surety and Resident General Agent, if the Surety is a foreign or alien surety and shall be accompanied with copies of current Certificate of Authority to do business on Guam issued by the Department of Revenue and Taxation, Power of Attorney issued by the Surety to the Resident General Agent and Power of Attorney issued by two major officers of the Surety to whoever is signing on their behalf. Certified check or cashier's check must be issued by a banking institution licensed to do business on Guam and shall be made payable to the Port Authority of Guam. Such bid bond or check shall be submitted with the understanding that it shall guarantee that the bidder will not withdraw his bid for a period of sixty (60) calendar days after the scheduled closing time for the receipt of bids; that if his bid is accepted, he will enter into a formal contract with the Owner in accordance with the form of agreement included as a part of the contract

documents, and that the required performance and payment bond will be given; and that in the event of the withdrawal of said bid within said period, or the failure to enter into said contract and give said bond within ten (10) working days after he has received notice of the acceptance of his bid, the bidder shall be liable to the Owner for the full amount of the bid guarantee as representing the damage to the Owner on account of the default of the bidder in any particular hereof. The bid guarantee shall be returned to all except the three lowest bidders within three days after the formal opening of bids. The bid guarantee of the second and/or third low bidder shall be returned thirty (30) calendar days after the bid opening date upon request, provided that he has not been notified by the Owner of the acceptance of his bid prior to the date of such request. The bid guarantee of the lowest qualified bidder shall be returned within forty eight (48) hours after the Owner and the qualified bidder have executed the contract.

4. Withdrawal of Bids

Bids may be withdrawn on written or telegraphic request received from bidders prior to the time fixed for opening. Negligence on the part of the bidder in preparing the bid confers no right to the withdrawal of the bid after it has been opened.

5. Publicity of Bids

At the time fixed for the opening of bids, the contents of the bids will be made public for the information of bidders and others properly interested who may be present either in person or by representation.

6. Receipt and Opening of Bids

(a) Bids will be opened publicly at the time and place stated in the invitation for bids. The officer whose duty it is to open them will decide when the specified time has arrived and bids received thereafter will not be considered. No responsibility will be attached to any officer for the premature opening of a bid not properly addressed and identified.

(b) Telegraphic bids will not be considered, but modifications by telegraph of bids already submitted will be considered if received prior to time set for opening.

7. Rejection of Bids

The Owner reserves the right to reject any and all bids when such rejection is in the interest of the Owner and to reject the bid of a bidder who is not in a position to perform the contract.

8. Award of Contract

(a) The contract will be awarded as soon as possible to the lowest responsive and responsible bidder, provided it is in the interest of the Owner to accept his bid.

(b) The Owner reserves the right to waive any informality in bids received when such waiver is in the interest of the Owner. The Owner also reserves the right to accept any item in the bid and to reject any item in the bid unless

otherwise specified by the Owner.

9. **Performance and Payment Bond**

The successful bidder must deliver to the Owner an executed performance and payment bond (forms enclosed) in an amount at least equal to one hundred percent (100%) of the accepted bid as security for the faithful performance of the contract and security for the payment of all persons performing labor and furnishing materials in connection with this contract. The sureties of all bonds shall be such surety company or companies as are approved by the Owner and as are authorized to transact business in Guam. The bonds must be approved by the Owner prior to execution of the formal contract.

10. **Cancellation of Award**

The Owner reserves the right to cancel the award of any contract at any time before the execution of same.

IV. DUTIES OF CONTRACTING OFFICER AND CONTRACTOR SAFETY MEASURES

1. **Authority of Contracting Officer**

The Contracting Officer shall give all orders and directions contemplated under this contract and specifications relative to the execution of the work. The Contracting Officer shall determine the amount, quality, acceptability, and fitness of the several kinds of work and materials which are to be paid or under this contract and shall decide all questions which may arise in relation to paid work and the construction thereof. The Contracting Officer's estimates and decisions shall be final and conclusive, except as herein otherwise expressly provided. In case any question shall arise between the parties hereto relative to said contract or specifications, the determination or decision of the Contracting Officer shall be a condition precedent to the right of the Contractor to receive any money or payment for work under this contract affected in any manner or to any extent by such question.

The Contracting Officer shall decide the meaning and intent of any portion of the specifications and of any plans or drawings where the same may be found obscure or be in dispute.

Any difference or conflicts in regard to their work which may arise between the Contractor under this contract and other Contractors performing work for the Owner shall be adjusted and determined by the Contracting Officer.

2. **Contractor's Obligations**

The Contractor shall, in good workmanlike manner, do and perform all work and furnish all supplies and materials, machinery, equipment, facilities and means, except as herein otherwise expressly specified, necessary or proper to perform and complete all the work required by this contract within the time herein specified in accordance with the plans and drawings of the work covered by this contract and any and all supplemental plans and drawings, and in accordance with the directions

of the Contracting Officer as given from time to time during the progress of the work. He alone shall be responsible for the safety, efficiency and adequacy of his plant, appliances and methods, and for any damage which may result from their failure or their improper construction, maintenance or operations. The Contractor shall observe, comply with and be subject to all terms, conditions, requirements, and limitations of the contract and specifications and shall do carry on and complete the entire work to the satisfaction of the Contracting Officer and the Owner.

3. Superintendence by Contractor

The Contractor shall give his personal superintendence to the work or have a competent foreman or superintendent, satisfactory to the Contracting Officer, on the work at all times during progress with authority to act for him.

4. Subcontracts

(a) Nothing contained in the specifications or drawings shall be construed as creating any contractual relationship between any subcontractor and the Owner. The diffusion or sections of the specifications are not intended to control the Contractor in dividing the work among subcontractors or to limit the work performed by any trade.

(b) The Contractor shall be as fully responsible to the Owner for the acts and omissions of subcontractors and of persons employed by them, as he is for the acts and omissions of persons directly employed by him.

(c) The Contractor shall be responsible for the coordination of the trades, subcontractors, and material-men engaged in his work.

(d) The Contractor shall, without additional expense to the Owner, utilize the services of specialty subcontractors on those parts of the work which are specified to be performed by specialty subcontractors.

(e) The Owner will not undertake to settle any differences between the Contractor and his subcontractors or between subcontractors.

(f) The Contractor shall cause appropriate provisions to be inserted in all subcontracts relative to the work including waiver of mechanics liens to bind subcontractors by the terms of the General Conditions and other contract documents insofar as applicable to the work of subcontractors and to give the Owner any exercise over the Contractor under any provisions of the contract documents.

5. Subletting

Subletting part of the work is permitted. However, bidder must note that subletting in excess of the following is not allowed:

(a) Where the subletting is for both labor and material, total cost of sublet work shall not exceed 50% of the contract amount.

- (b) Where subletting is for labor only, sublet work cost shall not exceed 30% of the total labor contract amount. Information concerning subcontracts must form a part of the bid documents and shall be submitted on standard "Subcontract" information form.

6. Assignments

The Contractor shall not assign the whole or any part of this contract or any monies due or to become due hereunder without the written consent of the Owner and of all the sureties executing any bonds on behalf of the Contractor in connection with said contract. In case the Contractor assigns the whole or any part of said contract or assigns all or any part of any monies due or to become due under said contract, the instrument of assignment shall contain a clause substantially to the effect that it is agreed that the right of the assignee in and to any monies due or to become due the Contractor or otherwise shall be subject to all of the terms and conditions of said contract or supplemental thereto, the rights and remedies of the Owner thereunder or arising by operation of the law and to the liens of all persons, firms, and corporations for services rendered or materials supplied in connection with the performance of said contract.

7. Equal Opportunity

- (a) The Contractor will not discriminate against any employee or applicant for employment because of race, religion, sex, color, age, economic status, or national origin. The Contractor will take affirmative action to insure that qualified applicants are employed and that employees are treated during employment without regard to their race, religion, sex, color, age, economic status, or national origin. Such action shall include, but not be limited to, the following: Employment, upgrading, demotion or transfer, recruitment or recruitment advertising, layoffs or termination, rates of pay or other forms of compensation, and selection for training including apprenticeship. The Contractor agrees to post in conspicuous places, available to employees and applicants for employment, notices to be provided by the Contracting Officer setting forth the provisions of this nondiscrimination clause.
- (b) The Contractor will, in all solicitations or advertisements for employees placed by or on behalf of the Contractor, state that all qualified applicants will receive consideration for employment without regard to race, religion, sex, color, age, economic status, or national origin.
- (c) The Contractor will send to each labor union or representative of workers with which he has a collective bargaining agreement or other contract or understanding, a notice, to be provided by the Contracting Officer, advising the said labor union or workers' representative of the Contractor's commitments under Section 202 of Executive Order No. 11246 of September 24, 1965 and shall post copies of the notice in conspicuous places available to employees and applicants for employment.

8. Hiring of Apprentices

The Contractor shall, except of good cause shown, hire for performance of work under this contract, to the extent possible, apprentices in each occupation to be employed in the performance of work under this contract in accordance with Executive Order No. 2000-10 dated April 11, 2000.

9. Minimum Wage Rate

All persons employed on this project shall be paid not less than minimum wage applicable to the corresponding skill or craft as determined by the Department of Labor, Government of Guam. Prevailing wage rates of Department of Labor, Government of Guam are attached herewith and shall be deemed a part of the contract documents.

10. Laws, Permits and Regulations

- (a) The DPW building, and federal permit that is required for the project shall be secured and paid for by the Contractor.
- (b) The Contractor shall pay all fees and charges for connection to outside service and use of property other than the site of the work for storage of materials or other purposes.
- (c) The Contractor shall comply with all laws, ordinances, regulations and building code requirements applicable to work hereunder unless in conflict with contract requirements. If the Contractor ascertains at any time that any requirement of this contract is a variance with applicable laws, ordinances, regulations, or building code requirements, he shall promptly notify the Contracting Officer and any necessary adjustment of the contract shall be made as specified under Changes in Work.

11. Contractor's and Subcontractor's Insurance

- (a) Prior to commencing the work, Contractor shall obtain and thereafter maintain during the course of the work Insurance with companies acceptable to Owner. The Contractor shall not allow any subcontractor to commence work on his subcontract until all similar insurance required of the subcontractor has been so obtained and approved. The limits of insurance shall be as follows unless a higher limit is required by statute:
 - i. Comprehensive General Liability including products, completed operations and contractual coverage for this Agreement in the amount of \$1,000,000 combined single limit. Owner shall be an additional insured.
 - ii. Auto Liability Insurance covering bodily injury and property damage in the amount of \$1,000,000 combined single limit. Owner shall be an additional insured.
 - iii. Excess Liability Policy with limits of \$1,000,000 or higher.

- iv. Owner shall be an additional insured.
- v. Worker's Compensation and Employer's Liability- Statutory limits. Add Waiver of Subrogation endorsement in favor of Owner.
- vi. Builder's Risk or Installation Floater, when applicable, is to be furnished by Contractor, which shall include Owner as named insured.

(b) Contractor shall furnish certificates of insurance and waiver of subrogation endorsement to Owner prior to commencement of work showing evidence of such coverage, including the statement to the effect that cancellation or termination of the insurance shall not be effective until at least ten (10) days after receipt of written notice to Owner. At all times Contractor's insurance shall be primary to any other insurance that may be carried by Owner. The statement of limits of insurance coverage shall not be construed as in any way limiting the Contractor's liability under this agreement. Owner shall be an additional insured on all liability coverage and certificates of insurance shall clearly indicate as such.

11. Indemnity

(a) Indemnity: The Contractor shall indemnify, defend and hold harmless Owner against all loss, damage, or expense (including reasonable attorney's fees incurred by Owner) arising out of the performance of the work, including injury or death to any person or persons resulting from the acts of omission of the Contractor or the Contractor's employees, servants, agents or subcontractors and from mechanics and material man's liens.

12. Accident Prevention

(a) Precaution shall be exercised at all times for the protection of persons (including employees) and property. The safety provisions of applicable laws, building and construction codes shall be observed. Machinery equipment and all hazards shall be guarded or eliminated in accordance with the safety provisions of the latest edition of the Manual of Accident Prevention in Construction published by the Associated General Contractors of America to the extent that such provisions are not in contravention of applicable laws.

(b) Should typhoon warnings be issued, the Contractor shall take every practicable precaution to minimize damage and/or danger to persons, to the work, and to the adjacent property. These precautions shall include closing all openings, removing all loose materials, tools and/or equipment from exposed locations, and removing or securing scaffolding and all other temporary work.

13. Protection of Work and Property

The Contractor shall at all times safely guard the Owner's property from injury or loss in connection with this contract. He shall at all times safely guard and protect his own work and that of adjacent property (as provided by law and the contract documents) from damage. All passageways, guard fences, lights and other facilities required for protection by laws and regulations and local conditions must be provided and maintained.

14. Responsibility of Contractor to Act in Emergency

In case of an emergency which threatens loss or injury of property and/or safety or life, the Contractor shall act, without previous instructions from the Owner or Contracting Officer, as the situation may warrant. He shall notify the Contracting Officer thereof immediately thereafter of any compensation claimed by the Contractor. Substantiating documents regarding expenses shall be submitted to the Owner through the Contracting Officer and the amount of compensation shall be determined by agreement or by the Contracting Officer subject to review procedures provided under Guam's Procurement Law and Claims Act.

15. Mutual Responsibility of Contractors

If the Contractor or any of his subcontractors or employees causes loss or damage to any separate contractor on the work, the Contractor agrees to settle with such separate contractor by agreement, if he will so settle. If such separate contractor sues the Owner on account of any loss so sustained, the Owner shall notify the Contractor who shall indemnify and save harmless the Owner against any expenses or judgments arising therefrom.

16. Use of Premises and Removal of Debris:

The Contractor expressly agrees to undertake at his own expense

- (a) to take every precaution against injuries to persons or damages to property;
- (b) to comply with the regulations governing the operation of premises which are occupied and to perform his contract in such a manner as not to interrupt or interfere with the operation of other facilities;
- (c) to perform any work necessary to be performed after regular working hours or on Sundays or legal holidays without additional expense to the Owner;
- (d) to store his apparatus, materials, supplies, and equipment in such orderly fashion at the site of the work as will not unduly interfere with the progress of his work or the work of any other contractors;
- (e) to place upon the work or any part thereof only such loads as are consistent with the safety of that portion of the work;
- (f) to frequently clean up all refuse, rubbish, scrap materials and debris caused by his operation so that at all times the site of the work shall present a neat,

orderly and workmanlike appearance;

- (g) to effect all cutting, fitting, or patching of his work required to make the same conform to the plans and specifications, and except with the consent of the Contracting Officer, not to cut or otherwise alter the work of any contractor;
- (h) before final payment to remove all surplus materials, false work, temporary structures, including foundations thereof, plant of any description and debris of every nature resulting from his operations, to put the site in a neat, orderly condition and to thoroughly clean and leave reasonably dust free all furnished surfaces.

17. **Obstructions**

The Contractor shall at his own expense remove all obstructions, the removal of which shall be necessary for the proper reception, performance, construction, installation and completion of all work under this contract.

18. **Site of Contractor's Operations**

The Contractor shall confine all construction operations within the vicinity of the site and shall arrange his work so that all construction materials and equipment are placed in such manner and location that there may be a minimum of interference or inconvenience inflicted upon the public and employees of the Government.

19. **Barricades**

The Contractor shall erect, install and maintain all temporary public walks, warning signs, barricades or other protective means in and around the site as deemed necessary or as may be ordered by the Contracting Officer for the effective protection of the public from injury and shall be held strictly liable for their safety.

20. **Electrical Energy**

The Contractor shall make all necessary applications, pay all fees and charges, obtain necessary permits and provide and maintain his own electrical power and light as required and necessary in the progress of any branch of the work. He shall provide all temporary wiring necessary.

21. **Water**

The Contractor shall make all necessary applications, pay all fees and charges, and obtain necessary permits for construction of temporary water required for use on this project. The nearest available source of water tap shall be verified by the Contractor. The Contractor shall be responsible for all expenses required for conveying water to the site from the available nearest source.

22. **Signs**

The Contractor shall erect a sign at the project site at his own expense. The location of the sign shall be as directed by the Contracting Officer. Size of signs, lettering, and other pertinent data that should appear on the sign will be furnished by the Contracting Officer to the Contractor.

V. QUALITY OF WORK

1. Engineering and Layout

- (a) The Contractor shall provide competent engineering services to execute the work in accordance with the contract requirements. He shall verify the figures shown on the survey and approach drawings before undertaking any construction work and shall be responsible for the accuracy of the finished work.
- (b) The Owner has established or will establish such general reference points as will, in his judgment, enable the Contractor to proceed with the work. If the Contractor finds that any previously established reference points have been destroyed or displaced, he shall promptly notify the Owner.
- (c) The Contractor shall protect and preserve the established bench marks and monuments and shall make no changes in location without the written approval of the Owner. Any of them which may be lost or destroyed or which require shifting because of necessary changes in grades or locations shall be subject to prior approval by the Owner, be replaced and accurately located by the Contractor.

2. Shop Drawings, Materials and Workmanship

Unless otherwise specified, all materials and equipment incorporated in the work under the contract shall be new. All workmanship shall be first class and by persons qualified in the respective trades.

Shop Drawings

- (a) The Contractor shall submit, for the approval of the Contracting Officer, shop and setting drawings and schedules required by the specifications or that may be requested by the Contracting Officer and no work shall be fabricated by the Contractor, save at his own risk, until such approval has been given.
- (b) Drawings and schedules shall be submitted in quadruplicate (unless otherwise specified) accompanied by letter of transmittal which shall give a list of the numbers and dates of the drawings submitted. Drawings shall be complete in every respect and bound in sets.
- (c) The Contractor shall submit all drawings and schedules sufficiently in advance of construction requirements to allow ample time for checking, correcting, resubmitting and rechecking.
- (d) The drawings submitted shall be marked with the name of the project, numbered consecutively and bear the stamp of approval of the Contractor as evidence that the drawings have been checked by the Contractor. Any drawings submitted without this stamp of approval will not be considered and will be returned to the Contractor for resubmission. If the shop

drawings show variations from the requirements of the contract because of standard shop practice or other reasons, the Contractor shall make specific mention of such variation in his letter of transmittal in order that if applicable, suitable action may be taken for proper adjustment. Otherwise, the Contractor will not be relieved of the responsibility for executing the work in accordance with the contract even though such shop drawings have been approved.

- (e) If a drawing as submitted indicates a departure from the contract requirements which the Contracting Officer finds to be in the interest of the Owner and to be so minor as not to involve a change in the contract price or time for performance, he may approve the drawings.
- (f) The approval of shop and setting drawings will be general and, except as otherwise provided in paragraph 2 (e), shall not be construed (1) as permitting any departure from the contract requirements; (2) as relieving the Contractor of the responsibility for any error in details, dimensions or otherwise that may exist; (3) as approving departures from additional details or instructions previously furnished by the Contracting Officer.

3. Standards

- (a) Any material specified by reference to the number, symbol or title of a specific standard, such as a commercial standard, a Federal specification, a trade association standard or other similar standard, shall comply with the requirements in the latest revision thereto in effect on the date of Invitation for Bids, except as limited to type, class or grade or modified in such reference.
- (b) The standard referred to, except as modified in the specifications, shall have full force and effect as though printed in the specifications. These standards are not furnished to bidders for the reason that the manufacturers and trades involved are assumed to be familiar with their requirements. The Contracting Officer will furnish, upon request, information as to how copies of such standards may be obtained.
- (c) Reference in the specifications to any article, device, product, material, fixture, form, or type of construction by name, make or catalog number shall be interpreted as establishing a standard of quality and shall not be construed as limiting competition; and the Contractor, in such cases, may at his option use any article, device, product, material, fixture, form of type of construction which in the judgment of the Contracting Officer expressed in writing is equal to that specified.

4. Samples

- (a) The Contractor shall furnish for the approval of the Contracting Officer any samples required by the specifications or that may be required by the Contracting Officer of any and all materials or equipment he proposes to use and shall prepay all shipping charges on the samples.

- (b) No samples are to be submitted with bids.
- (c) No materials or equipment of which samples are required to be submitted for approval shall be used on the work until such approval has been given by the Contracting Officer, save only at the Contractor's risk and expense.
- (d) Each sample shall have a label indicating the material represented, its place of origin and the names of the producer, the Contractor and the building or work for which the material is intended. Samples of finished materials shall be so marked as to indicate where the materials represented are required by the drawings or specifications.
- (e) A letter in duplicate submitting each shipment of samples shall be mailed under separate cover by the Contractor and contain a list of the samples, the name of the building or work for which the materials are intended, and the brands of the materials and names of the manufacturers.
- (f) The approval of any sample shall be only for characteristics or for the named in such approval and no other. No approval of a sample shall be taken in itself to change or modify any contract requirement. When a material has been approved, no additional sample of that material will be considered and no change in brand or make will be permitted. Approval of samples of hardware in good condition may be suitably marked for identification and used in the work.
- (g) Failure of any material to pass the specified tests will be sufficient cause for refusal to consider under this contract any further samples of the same brand or make of that material.
- (h) Test samples as the Contracting Officer may deem necessary will be procured from the various materials or equipment delivered by the Contractor for use in the work. If any of these test samples fail to meet the specifications requirement, any previous approvals will be withdrawn and such materials or equipment shall be subject to removal and replacement by the Contractor with materials or equipment meeting the specification requirements, or at the discretion of the Owner, the defective materials and equipment may be permitted to remain in place subject to a proper adjustment of the contract price. The cost of the tests will be borne by the Owner except where laboratory tests as hereinafter specified are required by the specifications.

5. Laboratory Tests

- (a) Any specified laboratory tests of materials and finished articles to be incorporated in the work shall be made by bureaus, laboratories or agencies approved by the Contracting Officer, and the reports of such tests shall be submitted to the Contracting Officer. The cost of the testing shall be paid for by the Contractor.

6. **Methods**

The Contractor shall use proper and efficient methods and appliances for the performance of all the operations connected with work embraced under these specifications, drawings and contract to secure a rate of progress which will secure completion of the work within the time specified. If, at any time before commencement of work, or during the progress thereof, such methods, equipment or appliances are inefficient or inappropriate for securing said quality of work or said rate of progress, the Contracting Officer may order the Contractor to increase their efficiency or to improve their character, and the Contractor must conform to such order. The failure of the Contracting Officer to demand such increases of efficiency or improvement shall not relieve the Contractor or his sureties from the obligations to secure such quality of work and said rate of progress and the completion of the work as required herein.

7. **Labor and Materials**

The Contractor shall furnish all labor, materials and equipment for the execution of the work according to the drawings, specifications and contract, and where no specifications are contained therein for whatever may be necessary, shall do all that may be termed ordinary, customary or essential to a job to be well and reliably completed. This includes concealment of all pipes and other rough items of installation if not clearly so shown on the drawings in a manner acceptable to the Contracting Officer. Structural safety shall not be impaired by such concealment. Work not particularly detailed, marked or specified shall be of equal quality as similar parts that are detailed, marked or specified. All material finished for and used in the job shall be of kind and grade specified and where not specifically called for at least of customary standard grade. All work shall be executed in accordance with their trades. Full structural safety is essential and the Contractor guarantees to accomplish same for the entire work.

8. **Guarantee of Work**

- (a) Except as otherwise specified all work shall be guaranteed by the Contractor against defects resulting from the use of inferior materials, equipment, or workmanship for one year from the date of final completion of the contract or from full occupancy of the building by the Owner, whichever is earlier.
- (b) If within any guarantee period, repairs or changes are required in connection with guaranteed work which, in the opinion of the Contracting Officer, is rendered necessary as the result of the use of materials, equipment or workmanship which are inferior, defective or not in accordance with the terms of the contract, the Contractor shall promptly upon receipt of notice from the Owner and without expense to the Owner:
 - (1) Place in satisfactory condition in every particular all of such guaranteed work and correct all defects therein; and
 - (2) Make good all damages to the building or site or equipment or contents thereof which, in the opinion of the Contracting Officer, are the result

of the use of materials, equipment or workmanship which are inferior, defective or not in accordance with the terms of the contract.

- (c) In any case wherein fulfilling the requirements of the contract or of any guarantee embraced in or required thereby the Contractor disturbs any work guaranteed under another contract, he shall restore such disturbed work to a condition satisfactory to the Contracting Officer and guarantee such restored work to the same extent as it was guaranteed under such other contract.
- (d) If the Contractor, after notice, fails to proceed promptly to comply with the terms of the guarantee, the Owner may have the defects corrected and the Contractor and his surety shall be liable for all expense incurred.
- (e) All special guarantees applicable to definite parts of the work shall be stipulated in the specifications or other papers forming a part of the contract and shall be subject to the terms of this paragraph during the life of such special guarantee.

9. **Defective Work**

No work or material which may be defective in construction or quality or deficient in any of the requirements of the drawings and specifications will be considered accepted as a consequence of the failure of the Contracting Officer or the inspectors to discover or to point out said defects or deficiencies during the construction; nor will the presence of inspectors on the work relieve the Contractor from the responsibility of securing the quality and progress of work as required by these specifications.

Any defective work that may be discovered before the completion of the work or within such time as required by the bond shall be replaced by work and materials that shall conform to the spirit and intent of the drawings, specifications and contract.

The fact that the Contracting Officer or his representatives may have overlooked defective work shall not constitute the acceptance of work.

NO PAYMENT WHETHER PARTIAL OR FINAL SHALL BE CONSTRUED TO BE AN ACCEPTANCE OF DEFECTIVE WORK OR IMPROPER MATERIALS.

The Contracting Officer may at any time by order given in writing stop any work not being done according to drawings and specifications and any order so given shall not in any way relieve the Contractor from completing his contract and shall not in any way terminate, cancel or abrogate the contract or any part thereof, and the Port Authority of Guam shall not in any way be responsible for the delay due to stopping the work as aforesaid.

VI. INSPECTION OF WORK

1. **Access to the Work**
The Contracting Officer and his representatives shall have access at all times to the work for inspection whatever it is in preparation or progress and the Contractor shall provide proper facilities for such access and inspection.
2. **Inspectors**
Inspectors may be placed by the Contracting Officer to supervise each and every subdivision of the work or any parts or process thereof. The Contracting Officer and the inspectors shall have free access to all parts of the work at all times and shall be given every facility, information and means of thoroughly inspecting the work done and the materials used or to be used.

The inspectors shall at all times be free to perform their duties and any intimidation of any inspector by the Contractor or the employees thereof shall be sufficient reason, if the Owner shall so decide, to annul the contract.

3. **As-Built Drawings**
A contract set of drawings shall be maintained at the site with all changes or deviations from the original drawings neatly marked thereon in brightly contrasting color. This shall be a separate set of drawings not used for construction purposes which shall be kept up to date as the job progresses and shall be made available for inspection by the Contracting Officer at all times. The Contractor shall submit a record copy of as-built drawings and an electronic file of as-built drawings within thirty (30) days of the substantial completion and/or final acceptance of the project. As-built drawings shall be marked "As-Built Drawing" with Contractor's signature and date. The electronic file of as-built drawings shall be drawn in Auto Cad Release 14 or later version as required by the Contracting Officer.
4. **As-Built Record of Materials:**
Unless provided under the contract specifications, furnish within 10 calendar days of the beneficial occupancy date a record of materials used prior to completion of the contract. Submission of this data is a condition for final payment under the contract.
5. **Inspection**
 - (a) All materials and workmanship (if not otherwise designated by the specifications) shall be subject to inspection, examination and testing by the Contracting Officer at any and all times during manufacture and/or construction and at any and all places where such manufacture and/or construction are carried on. The Contracting Officer shall have the right to reject defective material and workmanship or require its correction. Rejected workmanship shall be satisfactorily corrected, and rejected materials shall be satisfactorily replaced with proper materials and the Contractor shall promptly segregate and remove the rejected materials from the premises. If the Contractor fails to proceed at once with the replacement of rejected materials and/or the correction of defective workmanship, the Owner may, by contract or otherwise, replace such materials and/or correct

such workmanship and charge the cost to the Contractor, or may terminate the right of the Contractor to proceed as provided in paragraph 5 of Section VII, Time for Performance, the Contractor and surety being liable for any damage to the same extent as provided in said paragraph 16 for termination thereunder.

- (b) The Contractor shall furnish promptly, without additional charge, all reasonable facilities, labor and materials necessary for the safe and convenient inspection and tests that may be required by the Contracting Officer. All inspections and tests shall be performed in such manner as not to unnecessarily delay the work. Special, full-size and performance tests shall be as described in the specifications. The Contractor shall be charged with any cost of inspection when material and workmanship are not ready at the time inspection is requested by the Contractor.
- (c) Should it be considered necessary or advisable by the Contracting Officer at any time before final acceptance of the entire work to make an examination of work already completed by removing or tearing out same, the Contractor shall on request promptly furnish all necessary facilities, labor and materials. If such work is found to be defective in any material respect due to the fault of the Contractor or his subcontractors, he shall defray all the expenses of such examination and of satisfactory reconstruction.

If, however, such work is found to meet the requirements involved in the examination and replacement, the cost of conducting the test plus 15 percent shall be allowed the Contractor and he shall in addition, if completion of the work has been delayed thereby, be granted a suitable extension of time on account of the additional work involved.

6. Final Inspection

When the work is substantially completed the Contractor shall notify the Owner, in writing, that the work will be ready for final inspection and test on a definite date which shall be stated in such notice. The notice shall be given at least ten (10) calendar days in advance of said date and shall be forwarded through the Contracting Officer who will attach his endorsement as to whether or not he concurs in the Contractor's statement that the work will be ready for final inspection or tests on the date given but such endorsement shall not relieve the Contractor of this responsibility in the matter.

VII. TIME FOR PERFORMANCE

1. Prosecution of the Work

The Contractor agrees that said work shall be prosecuted regularly, diligently and without interruption at such rate of progress as will insure full completion thereof within the time specified. It is expressly understood and agreed by and between the Contractor and the Owner that the time for completion of the same takes into

consideration the average climatic range and usual industrial conditions prevailing in the locality.

2. Suspension of Work

The Owner will furnish all land and rights-of-way necessary for the carrying out of this contract and the completion of the work herein contemplated. Should the Owner be prevented or enjoined from proceeding with the work or from authorizing its prosecution, either before or after the commencement by reason of any litigation, the Contractor shall not be entitled to make or assert any claim for damage by reason of said delay, or to withdraw from the contract except by consent of the Owner, but time for completion of the work will be extended to such time as the Contracting Officer determines will compensate for the time lost by such delay determination to be set forth in writing.

3. Climatic Conditions

(a) When so ordered by the Contracting Officer, the Contractor shall suspend any work that may be subject to damage by climatic conditions.

(b) Contract Completion Time. The allowable work days for this contract were calculated after allowing for the following number of lost days in each month.

Time extension on account of inclement weather will be allowed only if the daily report of the Contracting Officer's inspector indicates lost days beyond the limits shown below. Time extension on account of inclement weather on Saturday and Sunday shall be granted only if the Contractor confirms in writing at least seven (7) days in advance his intention to work on weekends.

4. Progress Report

The Contractor shall submit monthly progress report in triplicate to the Contracting Officer briefly setting forth work accomplished.

5. Owner's Right to Stop Work or Terminate Contract, Delays, Damages

(a) The Owner's shall have the Right to Stop Work or Terminate the Contract for delays if:

(1) The Contractor shall be adjudged bankrupt or make an assignment for the benefit of creditors;

(2) A receiver or liquidator shall be appointed for the Contractor or for any of his property and shall not be dismissed within 20 calendar days after such appointment, or the proceedings in connection therewith shall not be stayed on appeal within the said 20 calendar days;

(3) The Contractor shall refuse or fail, after Notice of Warning from the Contracting Officer, to supply enough properly skilled workmen or

proper materials; or

- (4) The Contractor shall refuse to prosecute the work or any part thereof with such diligence as will insure its completion within the period herein specified (or any duly authorized extension thereof) or shall fail to complete the work within said period, or;
 - (5) The Contractor shall fail to make payments as specified to persons supplying labor or materials for the work, or;
 - (6) The Contractor shall fail or refuse to regard laws, ordinances or the instructions of the Contracting Officer or otherwise be guilty of a substantial violation of any provision(s) of this contract, then, and in any such event, the Owner, upon the certificate of the Contracting Officer that sufficient cause exists to justify such action, and without prejudice to any other rights or remedy he may have may, with 10 calendar days' notice to the Contractor, terminate the employment of the Contractor and his right to proceed, either as to the entire work or (at the option of the Owner) as to any portion thereof as to which delay shall have occurred, and may take possession of the work and complete the work by contract or otherwise as the Owner may deem expedient. In such case the Contractor shall not be entitled to receive any further payment on that work until the work is finished. If the unpaid balance of the compensation to be paid the Contractor hereunder shall exceed the expense of so completing the work (including compensation for additional managerial, administrative, and inspection services and any liquidated damages for delay), such excess shall be paid to the Contractor. If such expense shall exceed such unpaid balance, the Contractor and his sureties shall be liable to the Owner for such excess. If the right of the Contractor to proceed with the work is so terminated, the Owner may take possession of and utilize in completing the work such materials, supplies, plant, and equipment as may be on the site of the work and necessary therefore. The expenses incurred through the Contractor's default shall be certified by the Contracting Officer.
- (b) If the Owner does not terminate the right of the Contractor to proceed, the Contractor shall continue the work, in which event the Contractor shall pay to the Owner as fixed, agreed, and liquidated damages for each calendar day of the delay until work is completed or accepted the amount as set forth in the section of the specifications and the Contractor and his sureties shall be liable for the amount thereof.
 - (c) Provided that the right of the Contractor to proceed shall not be terminated, or the Contractor charged with liquidated damages because of any delays in the completion of the work due to unforeseeable cause beyond the control and without the fault or negligence of the Contractor including, but not restricted to, acts of God or of the public enemy, acts of the Owner, acts of

another Contractor in the performance of a contract with the Owner, fires, floods, epidemics, quarantine restrictions, strikes, freight embargoes, and unusually severe weather, or delays of subcontractors due to such cases, if the Contractor shall, within ten days from the beginning of any such delay (unless the Owner shall grant a further period of time prior to the date of final settlement of the contract) notify the Owner in writing of the causes of delay through the Contracting Officer, who shall ascertain the facts and the extent of the delay and extend the time for completing the work when in his judgment the findings of facts justify such an extension, and his findings of fact thereon shall be final and conclusive on the parties hereto subject only to review procedures provided under Guam's Procurement Law and Claims Act.

VIII. CLAIMS, PAYMENTS

1. Contractor's Title to Materials

No materials or supplies for the work shall be purchased by the Contractor or by any subcontractor subject to any chattel mortgage or under a conditional sale or other agreement by which an interest is retained by the seller. The Contractor warrants that he has good title to all materials and supplies for which he accepts partial payments.

2. Claims

The Contractor agrees whenever required to do so by the Owner to furnish satisfactory evidence that all persons, firms or corporations who have done work or supplied materials under these specifications have been paid or have been duly notified of the completion of the work and have been secured to their satisfaction before the said Contractor shall be entitled to final payment.

In case such evidence is not furnished or in case any claim is filed with the Owner or any suit or action is instituted against the Owner as defendant or garnishee or against the Contractor in connection with the work performed or to be performed under the drawings, specifications or contract, the Owner may retain from the money due or to become due to the Contractor such sum or sums as in the judgment of the Contracting Officer will fully protect the Owner from loss, charge or expense by reason of such claim, suit or action. The Owner without prejudice to any other and further rights, may make any and all deductions for any loss, charge or expense sustained by it to which it would be entitled under the contract specifications or bond, or otherwise before paying over the balance of the sum or sums retained as aforesaid, if any, to the Contractor, his creditor, or any successful claimant against the Contractor.

No payment made or retained under this contract shall be held to relieve the Contractor and/or his sureties from his and/or their obligations under this bond to hold harmless and indemnify the Owner or its agents from any and all loss, charge or expense by reason of any unpaid claim whatsoever.

3. **Waiver of Mechanics Liens**

Contractor waives any right that he now has or in the future may have to claim a mechanic's lien against the real property or improvements thereon which are the subject of this contract, to secure payment for labor and materials furnished or to be furnished by him under this contract.

4. **Schedule of Values**

Within fourteen (14) days after receipt of notice to proceed, the Contractor shall submit for approval a schedule of the estimated values of the main branches of the work totaling the amount of the contract. The format to be used will be furnished by the Contracting Officer. These values will be used for determining partial payments and as a basis for changes in work as outlined in the General Conditions.

5. **Taxes**

The Contractor shall, without additional expense to the Owner, pay all applicable taxes. The successful bidder will be required to comply with the applicable sections of Titles 11 and 21 of the Guam Code Annotated, as regards to licenses and taxes. In addition to the general contractor's liability, subcontractors are also subject to these provisions. Subcontractors are also required to possess Guam Service Licenses. The Contractor will be required to submit a list of his subcontractors and the monetary amount of each subcontract.

6. **Materials, Services and Facilities**

It is understood that except as otherwise specifically stated in the contract documents, the Contractor shall provide and pay for all materials, labor, tools, equipment, water, light, power, transportation, superintendence, temporary construction of every nature whatsoever necessary to execute, complete and deliver the work within the specified time.

7. **Patents**

The Contractor shall hold and save the Owner and his officers, agents, servants, and employees harmless from liability of any nature or kind, including cost and expenses, for or on account of any patented or unpatented invention, process, article or appliance manufactured or used in the performance of the contract including its use by the Owner, unless otherwise specifically stipulated in the contract documents.

8. **Payment by Contractor**

The Contractor shall pay:

- (a) for all transportation and utility services not later than the 20th day of the calendar month following that in which such services are rendered;

- (b) for all materials, tools, and other expendable equipment to the extent of 90 percent of the cost thereof, not later than the 20th day of the calendar month following that in which such materials, tools and equipment are delivered at the site of the project, and the balance of the cost thereof not later than the 30th day following the completion of that part of the work in or on which such materials, tools and equipment are incorporated or used;
- (c) to each of his subcontractors, not later than the 5th day following each payment to the Contractor, the respective amounts allowed the Contractor on account of the work performed by his subcontractors, to the extent of such subcontractor's interest therein.

9. Extras

Except as otherwise herein provided, no charge for any extra work or materials will be allowed unless the same has been ordered in writing by the Owner and either the price is stated in such order or a definite acknowledgment is made that a change in price is involved subject to later determination.

10. Changes in Work

- (a) The Owner may at any time, by a written order, and without notice to the sureties, make changes in the drawings and specifications of this contract and within the general scope thereof. However, no change will be made which increases the total contract price without notice to sureties. In making any change, the charge or credit for the change shall be determined by the following method:

- (1) The actual cost of:

- I. Labor, including foreman

- II. Materials entering permanently into the work

- III. Equipment rental cost during time used on extra work

- IV. Power and consumable supplies

- V. Insurance

- VI. To the above cost there shall be added a fixed fee to be agreed upon, but not to exceed 15% of the net cost. This fee shall be compensation to cover the cost of supervision, overhead, bond, profit and other general expenses.

- (b) The Contractor shall, when required by the Owner, furnish to the Owner an itemized breakdown of the quantities and prices used in computing the value of any change that might be ordered.
- (c) In figuring changes, instructions for measurement of quantities set forth in

the specifications shall be followed.

- (d) If any part of the work as installed is at variance with the contract requirements, the Owner may, if he finds it to be in his interest, allow all or any part of such work to remain in place subject to a proper adjustment in the contract price.

11. Payment to Contractor

- (a) Unless otherwise provided in the specifications, the Owner will make partial payments to the Contractor after receipt and approval of the request for partial payment covering the work performed during the preceding calendar month. No payments for installed materials on the site will be made unless such request is accompanied by a receipt or certification showing that the Contractor has made payment in full for such work done. In preparing such estimates, preparatory work done shall not be considered for payment. Materials delivered to site shall be considered for payment subject to the following conditions:

- (1) The material shall be kept in a safe and enclosed warehouse or area located on site with restricted access.
- (2) The receipt and issue of material must be controlled by a stock card kept in the warehouse.
- (3) Insurance coverage required under Chapter IV Section 11 of the General Conditions shall include insurance of such material and shall include theft insurance.
- (4) Request for payment must be accompanied with certification and receipts indicating the cost of material and showing that Contractor has made full payment for such material.

- (b) In making such partial payments there shall be retained ten percent (10%) of the estimated amount until final completion and acceptance of all work covered by the contract. However, if the Contracting Officer, at any time after 50 percent of the work has been completed, finds that satisfactory progress is being made, he may authorize payment in full of each progress payment for work performed beyond the 50 percent stage of completion. Also, whenever the work is substantially complete, the Contracting Officer, if he considers the amount retained to be in excess of the amount adequate for the protection of the Government, at his discretion, may release to the Contractor all or a portion of such excess amount.

- (c) All materials and work covered by partial payments made shall thereupon become the sole property of the Owner, but this provision shall not be construed as relieving the Contractor from the sole responsibility for all materials and work upon which payment have been made, or the restoration

of any damaged work or as a waiver of the right of the Owner to require the fulfillment of all of the terms of the contract.

- (d) Release of Claims - Neither the final payment or any part of the retained percentage shall become due until the Contractor shall deliver to the Owner through the Contracting Officer a complete release of all claims against the Owner arising under and by virtue of this contract, including claims of all subcontractors and suppliers of either materials or labor, other than such claims, if any, as may be specifically excepted by the Contractor.
- (e) Certificate of Completion - Upon completion and acceptance of all work whatsoever required and the release of all claims against the Owner as specified, the Contracting Officer shall file a written certificate with the Owner and with the Contractor as to the entire amount of work performed and compensation earned by the Contractor, including extra work and compensation therefore.
- (f) Final Payment - Within thirty (30) calendar days after the filing of such certificate of completion, the Owner shall pay to the Contractor the amount therein stated less all prior payments and advances whatsoever to or for the amount of the contract. All prior estimates and payments including those relating to extra work shall be subject to correction by this payment which is throughout this contract called Final Payment.
- (g) Acceptance of Final Payment Constitutes Release - The acceptance by the Contractor of the final payment shall be and shall operate as a release to the Owner of all claims and of all liability to the Contractor for all things done or furnished in connection with this work and for every act and neglect of the Owner and others relating to or arising out of this work, excepting the Contractor's claims for interest upon the final payments if this payment be improperly delayed. No payments, however, final or otherwise shall operate to release the Contractor or his sureties from any obligations under this contract or the performance and payment bonds.

MISCELLANEOUS

1. Prohibited Interests

- (a) No member or employee of the Guam Legislature or Delegate to Congress, shall be admitted to any share or part of this contract or to any benefit that may arise there from, but this provision shall not be construed to extend to this contract if made with a corporation for its general benefit.
- (b) No official or employee of the Government of Guam who is authorized in such capacity and on behalf of the Government to negotiate, make, accept or approve, or to take part in negotiating, making, accepting or approving any architectural, engineering, inspection, construction or material supply contract or any subcontract in connection with the construction of the project, shall become directly or indirectly interested personally in this

contract or in any part hereof. No officer, employee, architect, attorney, engineer, or inspector of or for the Government of Guam authorized to exercise any legislative executive supervisory or other similar functions in connection with the construction of the project, shall become directly or indirectly interested personally in this contract or in any part thereof, any material supply contract, subcontract, insurance contract, or any other contract pertaining to the project.

2. Disputes

- (a) Except as otherwise provided in this contract, any disputes arising under this contract shall be decided by the Contracting Officer, who shall reduce his decision to writing and mail or otherwise furnish a copy thereof to the Contractor. The decision of the Contracting Officer shall be final and conclusive. The provision shall not be pleaded in any suit involving a question of facts arising under this contract as limiting judicial review of any such decision to cases where fraud by such official or his representative is alleged. Provided, however, that any such decision shall be final and conclusive unless the same is fraudulent or capricious or arbitrary or so grossly erroneous as necessarily to imply bad faith or is not supported by substantial evidence.
- (b) This "Disputes" clause does not preclude consideration of questions of law in connection with decisions provided for in paragraph (2) above. Nothing in this contract, however, shall be construed as making final the decision of any administrative official representative or board on a question of law.

**** END OF GENERAL CONDITIONS ****

VOLUME 3
REQUIRED FORMS AND AFFIDAVITS



INVITATION FOR BID (IFB) NO. PAG-CIP-018-004

PROJECT TITLE: INSTALLATION OF METAL POLES AND FIXTURES WITH LED OR SOLAR LIGHTING

SPECIAL REMINDER TO PROSPECTIVE BIDDERS

Bidders are reminded to read the Instructions to Bidders attached to the IFB to ascertain that all of the following requirements checked below are submitted in the bid envelope, **one (1) original, two (2) copies, one (1) CD containing electronic file copy of all documents to be submitted**, at the date and time for it is due.

- (X) COMPETENCY OF BIDDERS REQUIREMENTS (Refer to Section II.13 of Vol. I)
- (X) BID FORM and BID SCHEDULE
- (X) BID SECURITY (15% of the bid)
- (X) AFFIDAVIT DISCLOSING OWNERSHIP AND COMMISSIONS (AG Form 002)
- (X) AFFIDAVIT RE NON-COLLUSION (AG Form 003)
- (X) AFFIDAVIT RE NO GRATUITIES OR KICKBACKS (AG Form 004)
- (X) AFFIDAVIT RE ETHICAL STANDARDS (AG Form 005)
- (X) DECLARATION RE COMPLIANCE WITH U.S. DOL WAGE DETERMINATION (AG Form 006)
- (X) AFFIDAVIT RE CONTINGENT FEES (AG Form 007)
- (X) OTHER REQUIREMENTS: (a) Valid Copy of Contractor's License and (b) Business License.

This reminder must be signed and included in the BID envelope. **Failure to comply with the above requirements will mean a disqualification and rejection of the proposal.**

On this ___ day of _____ 20___, I, _____, authorized representative of _____, acknowledge receipt of this Special Reminder to Prospective Bidders for the above referenced IFB and hereby attest that I have read and understand its intent and implications.

Signature of Authorized Representative

THIS REMINDER FORM MUST BE COMPLETED AND RETURNED IN THE ENVELOPE CONTAINING THE BID.

Rev. 10/95

BID FORM

Date: _____

To: General Manager
Port Authority of Guam
1026 Cabras Highway, Suite 201
Piti, Guam 96925

Gentlemen:

The undersigned (hereafter called the Bidder), a _____

(Corporation, Partnership or Individual)

organized and/or licensed to do business under the laws of _____, hereby proposes and agrees to furnish all of the necessary labor, materials, equipment, tools and services necessary for the **Design build to supply and install steel and aluminum poles with LED or Solar Lighting Fixtures**

_____ all in accordance with the drawings, specifications and other contract documents prepared by the Port Authority of Guam for the sum of _____ US Dollars (\$ _____) plus any and all sums to be added and/or deducted resulting from all extra and/or omitted work in accordance with the unit and/or lump sum prices stated in the itemized bid form attached hereto.

The undersigned has examined the location of the proposed work, the drawings, specifications and other contract documents and is familiar with the local conditions at the place where the work is to be performed.

The bid security attached, without endorsement, in the sum of not less than fifteen percent (15%) of the amount of the bid, is furnished to the Government as a guarantee that the contract will be executed and a performance and payment bond furnished within ten (10) working days after the acceptance of the bid of the undersigned. In the event that the undersigned bidder shall fail to execute the contract and furnish a satisfactory performance and payment bond under the conditions and within the time specified in this bid, the bid security shall be forfeited as liquidated damages for the delay and additional work and costs caused thereby in obtaining another bidder. The undersigned hereby agrees that the amount of the attached bid security is a reasonable forecast of potential damages and is not a penalty.

If written notice of the acceptance of this bid is mailed, telegraphed or delivered to the undersigned within sixty (60) calendar days after the opening thereof, the undersigned agrees to execute the form of agreement included as one of the contract documents, and to furnish a performance and payment bond in an amount equal to one hundred percent (100%) of the contract amount within ten (10) working days after receipt of such notice.

The undersigned hereby acknowledges receipt of the following addenda:

ADDENDUM NO.	DATED
_____	_____
_____	_____
_____	_____
_____	_____

If awarded the contract, the undersigned agrees to complete the work within the required contract period as defined in the bid documents. The undersigned understands that the Port Authority of Guam reserves the right to reject any or all bids or to waive any informality or technicality in any bids in the interest of the Government.

Attached hereto is an affidavit as proof that the undersigned has not engaged into any collusion with any person with respect to this bid or any other bid or the submitting of bids for the contract for which this bid is submitted.

RESPECTFULLY SUBMITTED BY:

(CONTRACTOR)

(BY)

(TITLE)

(BUSINESS ADDRESS)

BID BOND

BOND NO. _____

KNOW ALL MEN BY THESE PRESENTS, that _____
(Name of Contractor)

as Principal, hereinafter called the Principal and _____
(Name of Surety)

a duly admitted insurer under the laws of Guam, as Surety, hereinafter called the Surety, are held and firmly bound unto the Port Authority of Guam for the sum of _____ Dollars (\$ _____), for payment of which sum will and truly to be made, the said Principal and the said Surety bind ourselves, our heirs, executors, administrators, successors and assigns, jointly and severally, firmly by these presents.

WHEREAS, the Principal has submitted a bid for the Design Build to Supply and Install Steel and Aluminum poles with LED or Solar lighting fixtures

NOW THEREFORE, if the Port Authority of Guam shall accept the bid of the Principal and the Principal shall not withdraw said bid within sixty (60) calendar days after the opening of bids, and shall within ten (10) working days after the prescribed forms are presented to him for signature, enter into a Contract with the Port Authority of Guam in accordance with the terms of such bid and give such bond or bonds as may be specified in the bidding or Contract Documents with good and sufficient surety for the faithful performance of such Contract and for the prompt payment of labor and material furnished in the prosecution thereof, or in the event of the failure of the Principal to enter into such Contract and give such bond or bonds, if the Principal shall pay to the Port Authority of Guam the difference, not to exceed the amount hereof, between the amounts specified in said bid and such larger amount for which the Port Authority of Guam may in good faith contract with another party to perform work covered by said bid or an appropriate liquidated amount as specified in the Invitation for Bids then this obligation shall be null and void, otherwise to remain in full force and effect.

Signed and sealed this _____ day of _____.

(PRINCIPAL)

(SEAL)

(WITNESS)

(TITLE)

(MAJOR OFFICER OF SURETY)

(MAJOR OFFICER OF SURETY)

(TITLE)

(TITLE)

(RESIDENT GENERAL AGENT)

AFFIDAVIT DISCLOSING OWNERSHIP AND COMMISSIONS

CITY OF _____)
) SS.
 ISLAND OF GUAM)

A. I, the undersigned, being first duly sworn, depose and say that I am an authorized representative of the offeror and that *[please check only one]*:

The offeror is an individual or sole proprietor and owns the entire (100%) interest in the offering business.

The offeror is a corporation, partnership, joint venture, or association known as _____ *[please state name of offeror company]*, and the persons, companies, partners, or joint venturers who have held more than 10% of the shares or interest in the offering business during the 365 days immediately preceding the submission date of the proposal are as follows *[if none, please so state]*:

<u>Name</u>	<u>Address</u>	<u>% of Interest</u>
_____	_____	_____
_____	_____	_____
_____	_____	_____

B. Further, I say that the persons who have received or are entitled to receive a commission, gratuity or other compensation for procuring or assisting in obtaining business related to the bid or proposal for which this affidavit is submitted are as follows *[if none, please so state]*:

<u>Name</u>	<u>Address</u>	<u>Compensation</u>
_____	_____	_____

C. If the ownership of the offering business should change between the time this affidavit is made and the time an award is made or a contract is entered into, then I promise personally to update the disclosure required by 5 GCA §5233 by delivering another affidavit to the government.

 Signature of one of the following:

Offeror, if the offeror is an individual;
 Partner, if the offeror is a partnership;
 Officer, if the offeror is a corporation.

Subscribed and sworn to before me
 this ____ day of _____, 20__.

 NOTARY PUBLIC
 My commission expires: _____

AFFIDAVIT re NON-COLLUSION

CITY OF _____)
) ss.
 ISLAND OF GUAM)

_____ [state name of affiant signing below], being first duly sworn, deposes and says that:

1. The name of the offering company or individual is [state name of company]

2. The proposal for the solicitation identified above is genuine and not collusive or a sham. The offeror has not colluded, conspired, connived or agreed, directly or indirectly, with any other offeror or person, to put in a sham proposal or to refrain from making an offer. The offeror has not in any manner, directly or indirectly, sought by an agreement or collusion, or communication or conference, with any person to fix the proposal price of offeror or of any other offeror, or to fix any overhead, profit or cost element of said proposal price, or of that of any other offeror, or to secure any advantage against the government of Guam or any other offeror, or to secure any advantage against the government of Guam or any person interested in the proposed contract. All statements in this affidavit and in the proposal are true to the best of the knowledge of the undersigned. This statement is made pursuant to 2 GAR Division 4 § 3126(b).

3. I make this statement on behalf of myself as a representative of the offeror, and on behalf of the offeror's officers, representatives, agents, subcontractors, and employees.

 Signature of one of the following:
 Offeror, if the offeror is an individual;
 Partner, if the offeror is a partnership;
 Officer, if the offeror is a corporation.

Subscribed and sworn to before me
 this ____ day of _____, 201__.

 NOTARY PUBLIC
 My commission expires _____, _____.

AFFIDAVIT re NO GRATUITIES or KICKBACKS

CITY OF _____)
) ss.
ISLAND OF GUAM)

_____ [state name of affiant signing below], being first duly sworn, deposes and says that:

1. The name of the offering firm or individual is [state name of offeror company] _____ . Affiant is _____ [state one of the following: the offeror, a partner of the offeror, an officer of the offeror] making the foregoing identified bid or proposal.

2. To the best of affiant's knowledge, neither affiant, nor any of the offeror's officers, representatives, agents, subcontractors, or employees have violated, are violating the prohibition against gratuities and kickbacks set forth in 2 GAR Division 4 § 11107(e). Further, affiant promises, on behalf of offeror, not to violate the prohibition against gratuities and kickbacks as set forth in 2 GAR Division 4 § 11107(e).

3. To the best of affiant's knowledge, neither affiant, nor any of the offeror's officers, representatives, agents, subcontractors, or employees have offered, given or agreed to give, any government of Guam employee or former government employee, any payment, gift, kickback, gratuity or offer of employment in connection with the offeror's proposal.

4. I make these statements on behalf of myself as a representative of the offeror, and on behalf of the offeror's officers, representatives, agents, subcontractors, and employees.

Signature of one of the following:
Offeror, if the offeror is an individual;
Partner, if the offeror is a partnership;
Officer, if the offeror is a corporation.

Subscribed and sworn to before me

this _____ day of _____, 200__.

NOTARY PUBLIC
My commission expires _____, _____.

DECLARATION RE COMPLIANCE WITH U.S. DOL WAGE DETERMINATION

Procurement No.: _____

Name of Offeror Company: _____

I, _____ hereby certify under penalty of perjury:

(1) That I am _____ [please select one: the offeror, a partner of the offeror, an officer of the offeror] making the bid or proposal in the foregoing identified procurement;

(2) That I have read and understand the provisions of 5 GCA § 5801 and § 5802 which read:

§ 5801. Wage Determination Established.

In such cases where the government of Guam enters into contractual arrangements with a sole proprietorship, a partnership or a corporation ("contractor") for the provision of a service to the government of Guam, and in such cases where the contractor employs a person(s) whose purpose, in whole or in part, is the direct delivery of service contracted by the government of Guam, then the contractor shall pay such employee(s) in accordance with the Wage Determination for Guam and the Northern Mariana Islands issued and promulgated by the U.S. Department of Labor for such labor as is employed in the direct delivery of contract deliverables to the government of Guam.

The Wage Determination most recently issued by the U.S. Department of Labor at the time a contract is awarded to a contractor by the government of Guam shall be used to determine wages, which shall be paid to employees pursuant to this Article. Should any contract contain a renewal clause, then at the time of renewal adjustments, there shall be made stipulations contained in that contract for applying the Wage Determination, as required by this Article, so that the Wage Determination promulgated by the U.S. Department of Labor on a date most recent to the renewal date shall apply.

§ 5802. Benefits.

In addition to the Wage Determination detailed in this Article, any contract to which this Article applies shall also contain provisions mandating health and similar benefits for employees covered by this Article, such benefits having a minimum value as detailed in the Wage Determination issued and promulgated by the U.S. Department of Labor, and shall contain provisions guaranteeing a minimum of ten (10) paid holidays per annum per employee.

(3) That the offeror is in full compliance with 5 GCA § 5801 and § 5802, as may be applicable to the procurement referenced herein;

(4) That I have attached the most recent wage determination applicable to Guam issued by the U.S. Department of Labor. [INSTRUCTIONS - Please attach!]

Signature

DOL Wage Determination.pdf

WD 15-5694 (Rev.-6) was first posted on www.wdol.gov on 01/16/2018

REGISTER OF WAGE DETERMINATIONS UNDER
THE SERVICE CONTRACT ACT
By direction of the Secretary of Labor

U.S. DEPARTMENT OF LABOR
EMPLOYMENT STANDARDS ADMINISTRATION
WAGE AND HOUR DIVISION
WASHINGTON D.C. 20210

Daniel W. Simms
Director

Division of
Wage Determinations

Wage Determination No.: 2015-5694
Revision No.: 6
Date Of Revision: 01/10/2018

Note: Under Executive Order (EO) 13658, an hourly minimum wage of \$10.35 for calendar year 2018 applies to all contracts subject to the Service Contract Act for which the contract is awarded (and any solicitation was issued) on or after January 1, 2015. If this contract is covered by the EO, the contractor must pay all workers in any classification listed on this wage determination at least \$10.35 per hour (or the applicable wage rate listed on this wage determination, if it is higher) for all hours spent performing on the contract in calendar year 2018. The EO minimum wage rate will be adjusted annually. Additional information on contractor requirements and worker protections under the EO is available at www.dol.gov/whd/govcontracts

States: Guam, Northern Marianas, Wake Island

Area: Guam Statewide
Northern Marianas Statewide
Wake Island Statewide

Fringe Benefits Required Follow the Occupational Listing

OCCUPATION CODE - TITLE	FOOTNOTE	RATE
01000 - Administrative Support And Clerical Occupations		
01011 - Accounting Clerk I		13.53
01012 - Accounting Clerk II		15.19
01013 - Accounting Clerk III		17.00
01020 - Administrative Assistant		17.67
01035 - Court Reporter		17.01
01041 - Customer Service Representative I		10.13
01042 - Customer Service Representative II		11.39
01043 - Customer Service Representative III		12.43
01051 - Data Entry Operator I		11.49
01052 - Data Entry Operator II		12.54
01060 - Dispatcher, Motor Vehicle		14.37
01070 - Document Preparation Clerk		13.53
01090 - Duplicating Machine Operator		13.53
01111 - General Clerk I		10.29
01112 - General Clerk II		11.28
01113 - General Clerk III		12.32
01120 - Housing Referral Assistant		18.94
01141 - Messenger Courier		10.30
01191 - Order Clerk I		12.41
01192 - Order Clerk II		13.48
01261 - Personnel Assistant (Employment) I		15.57
01262 - Personnel Assistant (Employment) II		17.25
01263 - Personnel Assistant (Employment) III		19.22
01270 - Production Control Clerk		20.05
01290 - Rental Clerk		11.10
01300 - Scheduler, Maintenance		15.19
01311 - Secretary I		15.19
01312 - Secretary II		17.01
01313 - Secretary III		18.94
01320 - Service Order Dispatcher		12.73

DOL Wage Determination.pdf

01410 - Supply Technician	17.67
01420 - Survey Worker	15.26
01460 - Switchboard Operator/Receptionist	9.67
01531 - Travel Clerk I	12.77
01532 - Travel Clerk II	13.83
01533 - Travel Clerk III	14.78
01611 - Word Processor I	13.48
01612 - Word Processor II	15.13
01613 - Word Processor III	16.92
05000 - Automotive Service Occupations	
05005 - Automobile Body Repairer, Fiberglass	13.34
05010 - Automotive Electrician	13.06
05040 - Automotive Glass Installer	12.10
05070 - Automotive Worker	12.10
05110 - Mobile Equipment Servicer	10.13
05130 - Motor Equipment Metal Mechanic	13.71
05160 - Motor Equipment Metal Worker	12.10
05190 - Motor Vehicle Mechanic	13.71
05220 - Motor Vehicle Mechanic Helper	10.12
05250 - Motor Vehicle Upholstery Worker	12.10
05280 - Motor Vehicle Wrecker	12.10
05310 - Painter, Automotive	12.87
05340 - Radiator Repair Specialist	12.10
05370 - Tire Repairer	9.45
05400 - Transmission Repair Specialist	13.39
07000 - Food Preparation And Service Occupations	
07010 - Baker	10.47
07041 - Cook I	10.76
07042 - Cook II	12.49
07070 - Dishwasher	8.78
07130 - Food Service Worker	9.08
07210 - Meat Cutter	11.86
07260 - Waiter/waitress	9.12
09000 - Furniture Maintenance And Repair Occupations	
09010 - Electrostatic Spray Painter	16.17
09040 - Furniture Handler	9.87
09080 - Furniture Refinisher	16.17
09090 - Furniture Refinisher Helper	11.97
09110 - Furniture Repairer, Minor	14.07
09130 - Upholsterer	16.17
11000 - General Services And Support Occupations	
11030 - Cleaner, Vehicles	9.00
11060 - Elevator Operator	9.00
11090 - Gardener	12.32
11122 - Housekeeping Aide	9.23
11150 - Janitor	9.23
11210 - Laborer, Grounds Maintenance	9.34
11240 - Maid or Houseman	8.78
11260 - Pruner	8.36
11270 - Tractor Operator	11.32
11330 - Trail Maintenance Worker	9.34
11360 - Window Cleaner	10.31
12000 - Health Occupations	
12010 - Ambulance Driver	17.52
12011 - Breath Alcohol Technician	17.52
12012 - Certified Occupational Therapist Assistant	24.03
12015 - Certified Physical Therapist Assistant	24.03
12020 - Dental Assistant	13.38
12025 - Dental Hygienist	32.84
12030 - EKG Technician	23.96
12035 - Electroneurodiagnostic Technologist	23.96
12040 - Emergency Medical Technician	17.52
12071 - Licensed Practical Nurse I	15.66

DOL Wage Determination.pdf

12072	- Licensed Practical Nurse II		17.52
12073	- Licensed Practical Nurse III		19.52
12100	- Medical Assistant		11.54
12130	- Medical Laboratory Technician		15.55
12160	- Medical Record Clerk		12.37
12190	- Medical Record Technician		13.84
12195	- Medical Transcriptionist		15.66
12210	- Nuclear Medicine Technologist		38.49
12221	- Nursing Assistant I		11.03
12222	- Nursing Assistant II		12.43
12223	- Nursing Assistant III		13.54
12224	- Nursing Assistant IV		15.22
12235	- Optical Dispenser		17.52
12236	- Optical Technician		15.66
12250	- Pharmacy Technician		14.18
12280	- Phlebotomist		15.22
12305	- Radiologic Technologist		22.64
12311	- Registered Nurse I		20.70
12312	- Registered Nurse II		25.32
12313	- Registered Nurse II, Specialist		25.32
12314	- Registered Nurse III		30.64
12315	- Registered Nurse III, Anesthetist		30.64
12316	- Registered Nurse IV		36.72
12317	- Scheduler (Drug and Alcohol Testing)		21.69
12320	- Substance Abuse Treatment Counselor		21.69
13000	- Information And Arts Occupations		
13011	- Exhibits Specialist I		18.12
13012	- Exhibits Specialist II		22.43
13013	- Exhibits Specialist III		27.43
13041	- Illustrator I		18.12
13042	- Illustrator II		22.43
13043	- Illustrator III		27.43
13047	- Librarian		24.84
13050	- Library Aide/Clerk		14.42
13054	- Library Information Technology Systems Administrator		22.42
13058	- Library Technician		15.13
13061	- Media Specialist I		16.18
13062	- Media Specialist II		18.12
13063	- Media Specialist III		20.19
13071	- Photographer I		15.51
13072	- Photographer II		17.33
13073	- Photographer III		21.48
13074	- Photographer IV		26.29
13075	- Photographer V		31.82
13090	- Technical Order Library Clerk		15.49
13110	- Video Teleconference Technician		15.62
14000	- Information Technology Occupations		
14041	- Computer Operator I		15.71
14042	- Computer Operator II		15.76
14043	- Computer Operator III		17.56
14044	- Computer Operator IV		19.50
14045	- Computer Operator V		21.81
14071	- Computer Programmer I	(see 1)	15.73
14072	- Computer Programmer II	(see 1)	19.50
14073	- Computer Programmer III	(see 1)	23.84
14074	- Computer Programmer IV	(see 1)	
14101	- Computer Systems Analyst I	(see 1)	24.23
14102	- Computer Systems Analyst II	(see 1)	
14103	- Computer Systems Analyst III	(see 1)	
14150	- Peripheral Equipment Operator		15.71
14160	- Personal Computer Support Technician		19.50
14170	- System Support Specialist		21.24

DOL Wage Determination.pdf

15000 - Instructional Occupations	
15010 - Aircrew Training Devices Instructor (Non-Rated)	24.23
15020 - Aircrew Training Devices Instructor (Rated)	29.32
15030 - Air Crew Training Devices Instructor (Pilot)	33.30
15050 - Computer Based Training Specialist / Instructor	24.23
15060 - Educational Technologist	22.82
15070 - Flight Instructor (Pilot)	33.30
15080 - Graphic Artist	20.47
15085 - Maintenance Test Pilot, Fixed, Jet/Prop	32.62
15086 - Maintenance Test Pilot, Rotary Wing	32.62
15088 - Non-Maintenance Test/Co-Pilot	32.62
15090 - Technical Instructor	17.65
15095 - Technical Instructor/Course Developer	21.58
15110 - Test Proctor	13.87
15120 - Tutor	13.87
16000 - Laundry, Dry-Cleaning, Pressing And Related Occupations	
16010 - Assembler	9.78
16030 - Counter Attendant	9.78
16040 - Dry Cleaner	11.30
16070 - Finisher, Flatwork, Machine	9.78
16090 - Presser, Hand	9.78
16110 - Presser, Machine, Drycleaning	9.78
16130 - Presser, Machine, Shirts	9.78
16160 - Presser, Machine, Wearing Apparel, Laundry	9.78
16190 - Sewing Machine Operator	11.94
16220 - Tailor	12.44
16250 - Washer, Machine	10.24
19000 - Machine Tool Operation And Repair Occupations	
19010 - Machine-Tool Operator (Tool Room)	16.17
19040 - Tool And Die Maker	20.32
21000 - Materials Handling And Packing Occupations	
21020 - Forklift Operator	13.96
21030 - Material Coordinator	20.05
21040 - Material Expediter	20.05
21050 - Material Handling Laborer	11.37
21071 - Order Filler	9.66
21080 - Production Line Worker (Food Processing)	13.96
21110 - Shipping Packer	13.33
21130 - Shipping/Receiving Clerk	13.33
21140 - Store Worker I	13.93
21150 - Stock Clerk	19.55
21210 - Tools And Parts Attendant	13.96
21410 - Warehouse Specialist	13.96
23000 - Mechanics And Maintenance And Repair Occupations	
23010 - Aerospace Structural Welder	20.69
23019 - Aircraft Logs and Records Technician	16.09
23021 - Aircraft Mechanic I	19.70
23022 - Aircraft Mechanic II	20.69
23023 - Aircraft Mechanic III	21.74
23040 - Aircraft Mechanic Helper	13.70
23050 - Aircraft, Painter	18.50
23060 - Aircraft Servicer	16.09
23070 - Aircraft Survival Flight Equipment Technician	18.50
23080 - Aircraft Worker	17.38
23091 - Aircrew Life Support Equipment (ALSE) Mechanic I	17.38
23092 - Aircrew Life Support Equipment (ALSE) Mechanic II	19.70
23110 - Appliance Mechanic	16.17
23120 - Bicycle Repairer	11.78
23125 - Cable Splicer	18.67
23130 - Carpenter, Maintenance	14.09
23140 - Carpet Layer	15.12

DOL Wage Determination.pdf

23160 - Electrician, Maintenance	17.68
23181 - Electronics Technician Maintenance I	15.12
23182 - Electronics Technician Maintenance II	16.17
23183 - Electronics Technician Maintenance III	18.31
23260 - Fabric Worker	14.07
23290 - Fire Alarm System Mechanic	15.43
23310 - Fire Extinguisher Repairer	13.03
23311 - Fuel Distribution System Mechanic	17.22
23312 - Fuel Distribution System Operator	13.03
23370 - General Maintenance Worker	11.96
23380 - Ground Support Equipment Mechanic	19.70
23381 - Ground Support Equipment Servicer	16.09
23382 - Ground Support Equipment Worker	17.38
23391 - Gunsmith I	13.03
23392 - Gunsmith II	15.12
23393 - Gunsmith III	17.22
23410 - Heating, Ventilation And Air-Conditioning Mechanic	16.58
23411 - Heating, Ventilation And Air Contidioning Mechanic (Research Facility)	17.63
23430 - Heavy Equipment Mechanic	17.27
23440 - Heavy Equipment Operator	16.21
23460 - Instrument Mechanic	17.22
23465 - Laboratory/Shelter Mechanic	16.17
23470 - Laborer	11.37
23510 - Locksmith	16.17
23530 - Machinery Maintenance Mechanic	19.12
23550 - Machinist, Maintenance	17.22
23580 - Maintenance Trades Helper	9.92
23591 - Metrology Technician I	17.22
23592 - Metrology Technician II	18.31
23593 - Metrology Technician III	19.39
23640 - Millwright	17.22
23710 - Office Appliance Repairer	15.82
23760 - Painter, Maintenance	13.95
23790 - Pipefitter, Maintenance	17.47
23810 - Plumber, Maintenance	16.40
23820 - Pneudraulic Systems Mechanic	17.22
23850 - Rigger	17.22
23870 - Scale Mechanic	15.12
23890 - Sheet-Metal Worker, Maintenance	15.28
23910 - Small Engine Mechanic	15.12
23931 - Telecommunications Mechanic I	19.01
23932 - Telecommunications Mechanic II	19.76
23950 - Telephone Lineman	18.24
23960 - Welder, Combination, Maintenance	17.31
23965 - Well Driller	17.22
23970 - Woodcraft Worker	17.22
23980 - Woodworker	13.03
24000 - Personal Needs Occupations	
24550 - Case Manager	14.15
24570 - Child Care Attendant	10.09
24580 - Child Care Center Clerk	12.58
24610 - Chore Aide	13.93
24620 - Family Readiness And Support Services Coordinator	14.15
24630 - Homemaker	16.12
25000 - Plant And System Operations Occupations	
25010 - Boiler Tender	17.22
25040 - Sewage Plant Operator	17.53
25070 - Stationary Engineer	17.22
25190 - Ventilation Equipment Tender	11.97
25210 - Water Treatment Plant Operator	17.53

DOL Wage Determination.pdf

27000 - Protective Service Occupations	
27004 - Alarm Monitor	10.90
27007 - Baggage Inspector	8.90
27008 - Corrections Officer	12.05
27010 - Court Security Officer	12.05
27030 - Detection Dog Handler	10.90
27040 - Detention Officer	12.05
27070 - Firefighter	12.05
27101 - Guard I	8.92
27102 - Guard II	10.90
27131 - Police Officer I	12.05
27132 - Police Officer II	13.40
28000 - Recreation Occupations	
28041 - Carnival Equipment Operator	11.53
28042 - Carnival Equipment Repairer	12.20
28043 - Carnival Worker	9.03
28210 - Gate Attendant/Gate Tender	13.18
28310 - Lifeguard	11.01
28350 - Park Attendant (Aide)	14.74
28510 - Recreation Aide/Health Facility Attendant	10.76
28515 - Recreation Specialist	18.26
28630 - Sports Official	11.74
28690 - Swimming Pool Operator	17.71
29000 - Stevedoring/Longshoremen Occupational Services	
29010 - Blocker And Bracer	18.39
29020 - Hatch Tender	18.39
29030 - Line Handler	18.39
29041 - Stevedore I	17.14
29042 - Stevedore II	19.67
30000 - Technical Occupations	
30010 - Air Traffic Control Specialist, Center (HFO) (see 2)	37.52
30011 - Air Traffic Control Specialist, Station (HFO) (see 2)	25.87
30012 - Air Traffic Control Specialist, Terminal (HFO) (see 2)	28.49
30021 - Archeological Technician I	17.49
30022 - Archeological Technician II	19.56
30023 - Archeological Technician III	24.21
30030 - Cartographic Technician	23.18
30040 - Civil Engineering Technician	21.93
30051 - Cryogenic Technician I	23.08
30052 - Cryogenic Technician II	25.49
30061 - Drafter/CAD Operator I	17.49
30062 - Drafter/CAD Operator II	19.56
30063 - Drafter/CAD Operator III	20.74
30064 - Drafter/CAD Operator IV	24.21
30081 - Engineering Technician I	14.62
30082 - Engineering Technician II	16.41
30083 - Engineering Technician III	18.36
30084 - Engineering Technician IV	22.34
30085 - Engineering Technician V	27.83
30086 - Engineering Technician VI	33.66
30090 - Environmental Technician	21.10
30095 - Evidence Control Specialist	20.84
30210 - Laboratory Technician	20.74
30221 - Latent Fingerprint Technician I	23.08
30222 - Latent Fingerprint Technician II	25.49
30240 - Mathematical Technician	23.34
30361 - Paralegal/Legal Assistant I	19.44
30362 - Paralegal/Legal Assistant II	23.68
30363 - Paralegal/Legal Assistant III	28.99
30364 - Paralegal/Legal Assistant IV	33.88
30375 - Petroleum Supply Specialist	25.49
30390 - Photo-Optics Technician	21.93
30395 - Radiation Control Technician	25.49

DOL Wage Determination.pdf

30461 - Technical Writer I	22.17
30462 - Technical Writer II	27.10
30463 - Technical Writer III	32.79
30491 - Unexploded Ordnance (UXO) Technician I	23.85
30492 - Unexploded Ordnance (UXO) Technician II	28.85
30493 - Unexploded Ordnance (UXO) Technician III	34.58
30494 - Unexploded (UXO) Safety Escort	23.85
30495 - Unexploded (UXO) Sweep Personnel	23.85
30501 - Weather Forecaster I	23.08
30502 - Weather Forecaster II	28.08
30620 - Weather Observer, Combined Upper Air Or	(see 2) 20.74
Surface Programs	
30621 - Weather Observer, Senior	(see 2) 23.00
31000 - Transportation/Mobile Equipment Operation Occupations	
31010 - Airplane Pilot	28.85
31020 - Bus Aide	8.15
31030 - Bus Driver	9.69
31043 - Driver Courier	8.97
31260 - Parking and Lot Attendant	8.12
31290 - Shuttle Bus Driver	9.99
31310 - Taxi Driver	9.18
31361 - Truckdriver, Light	9.43
31362 - Truckdriver, Medium	11.61
31363 - Truckdriver, Heavy	13.89
31364 - Truckdriver, Tractor-Trailer	13.89
99000 - Miscellaneous Occupations	
99020 - Cabin Safety Specialist	14.07
99030 - Cashier	9.03
99050 - Desk Clerk	9.70
99095 - Embalmer	23.85
99130 - Flight Follower	23.85
99251 - Laboratory Animal Caretaker I	19.65
99252 - Laboratory Animal Caretaker II	20.61
99260 - Marketing Analyst	19.10
99310 - Mortician	23.85
99410 - Pest Controller	14.61
99510 - Photofinishing Worker	12.53
99710 - Recycling Laborer	11.84
99711 - Recycling Specialist	17.90
99730 - Refuse Collector	11.26
99810 - Sales Clerk	9.46
99820 - School Crossing Guard	15.82
99830 - Survey Party Chief	21.30
99831 - Surveying Aide	12.11
99832 - Surveying Technician	15.74
99840 - Vending Machine Attendant	21.42
99841 - Vending Machine Repairer	27.06
99842 - Vending Machine Repairer Helper	21.42

Note: Executive Order (EO) 13706, Establishing Paid Sick Leave for Federal Contractors, applies to all contracts subject to the Service Contract Act for which the contract is awarded (and any solicitation was issued) on or after January 1, 2017. If this contract is covered by the EO, the contractor must provide employees with 1 hour of paid sick leave for every 30 hours they work, up to 56 hours of paid sick leave each year. Employees must be permitted to use paid sick leave for their own illness, injury or other health-related needs, including preventive care; to assist a family member (or person who is like family to the employee) who is ill, injured, or has other health-related needs, including preventive care; or for reasons resulting from, or to assist a family member (or person who is like family

to the employee) who is the victim of, domestic violence, sexual assault, or stalking. Additional information on contractor requirements and worker protections under the EO is available at www.dol.gov/whd/govcontracts.

ALL OCCUPATIONS LISTED ABOVE RECEIVE THE FOLLOWING BENEFITS:

HEALTH & WELFARE: Life, accident, and health insurance plans, sick leave, pension plans, civic and personal leave, severance pay, and savings and thrift plans. Minimum employer contributions costing an average of \$4.41 per hour computed on the basis of all hours worked by service employees employed on the contract.

HEALTH & WELFARE EO 13706: Minimum employer contributions costing an average of \$4.13 per hour computed on the basis of all hours worked by service employees employed on the covered contracts. *

*This rate is to be used only when compensating employees for performance on an SCA-covered contract also covered by EO 13706, Establishing Paid Sick Leave for Federal Contractors. A contractor may not receive credit toward its SCA obligations for any paid sick leave provided pursuant to EO 13706.

VACATION: 2 weeks paid vacation after 1 year of service with a contractor or successor; and 4 weeks after 3 years. Length of service includes the whole span of continuous service with the present contractor or successor, wherever employed, and with the predecessor contractors in the performance of similar work at the same Federal facility. (Reg. 29 CFR 4.173)

HOLIDAYS: A minimum of ten paid holidays per year: New Year's Day, Martin Luther King Jr.'s Birthday, Washington's Birthday, Memorial Day, Independence Day, Labor Day, Columbus Day, Veterans' Day, Thanksgiving Day, and Christmas Day. (A contractor may substitute for any of the named holidays another day off with pay in accordance with a plan communicated to the employees involved.) (See 29 CFR 4.174)

THE OCCUPATIONS WHICH HAVE NUMBERED FOOTNOTES IN PARENTHESES RECEIVE THE FOLLOWING:

1) COMPUTER EMPLOYEES: Under the SCA at section 8(b), this wage determination does not apply to any employee who individually qualifies as a bona fide executive, administrative, or professional employee as defined in 29 C.F.R. Part 541. Because most Computer System Analysts and Computer Programmers who are compensated at a rate not less than \$27.63 (or on a salary or fee basis at a rate not less than \$455 per week) an hour would likely qualify as exempt computer professionals, (29 C.F.R. 541.400) wage rates may not be listed on this wage determination for all occupations within those job families. In addition, because this wage determination may not list a wage rate for some or all occupations within those job families if the survey data indicates that the prevailing wage rate for the occupation equals or exceeds \$27.63 per hour conformances may be necessary for certain nonexempt employees. For example, if an individual employee is nonexempt but nevertheless performs duties within the scope of one of the Computer Systems Analyst or Computer Programmer occupations for which this wage determination does not specify an SCA wage rate, then the wage rate for that employee must be conformed in accordance with the conformance procedures described in the conformance note included on this wage determination.

Additionally, because job titles vary widely and change quickly in the computer industry, job titles are not determinative of the application of the computer professional exemption. Therefore, the exemption applies only to computer employees who satisfy the compensation requirements and whose primary duty consists of:

(1) The application of systems analysis techniques and procedures, including consulting with users, to determine hardware, software or system functional specifications;

(2) The design, development, documentation, analysis, creation, testing or modification of computer systems or programs, including prototypes, based on and

related to user or system design specifications;

(3) The design, documentation, testing, creation or modification of computer programs related to machine operating systems; or

(4) A combination of the aforementioned duties, the performance of which requires the same level of skills. (29 C.F.R. 541.400).

2) AIR TRAFFIC CONTROLLERS AND WEATHER OBSERVERS - NIGHT PAY & SUNDAY PAY: If you work at night as part of a regular tour of duty, you will earn a night differential and receive an additional 10% of basic pay for any hours worked between 6pm and 6am. If you are a full-time employed (40 hours a week) and Sunday is part of your regularly scheduled workweek, you are paid at your rate of basic pay plus a Sunday premium of 25% of your basic rate for each hour of Sunday work which is not overtime (i.e. occasional work on Sunday outside the normal tour of duty is considered overtime work).

**** HAZARDOUS PAY DIFFERENTIAL ****

An 8 percent differential is applicable to employees employed in a position that represents a high degree of hazard when working with or in close proximity to ordnance, explosives, and incendiary materials. This includes work such as screening, blending, dying, mixing, and pressing of sensitive ordnance, explosives, and pyrotechnic compositions such as lead azide, black powder and photoflash powder. All dry-house activities involving propellants or explosives. Demilitarization, modification, renovation, demolition, and maintenance operations on sensitive ordnance, explosives and incendiary materials. All operations involving re-grading and cleaning of artillery ranges.

A 4 percent differential is applicable to employees employed in a position that represents a low degree of hazard when working with, or in close proximity to ordnance, (or employees possibly adjacent to) explosives and incendiary materials which involves potential injury such as laceration of hands, face, or arms of the employee engaged in the operation, irritation of the skin, minor burns and the like; minimal damage to immediate or adjacent work area or equipment being used. All operations involving, unloading, storage, and hauling of ordnance, explosive, and incendiary ordnance material other than small arms ammunition. These differentials are only applicable to work that has been specifically designated by the agency for ordnance, explosives, and incendiary material differential pay.

**** UNIFORM ALLOWANCE ****

If employees are required to wear uniforms in the performance of this contract (either by the terms of the Government contract, by the employer, by the state or local law, etc.), the cost of furnishing such uniforms and maintaining (by laundering or dry cleaning) such uniforms is an expense that may not be borne by an employee where such cost reduces the hourly rate below that required by the wage determination. The Department of Labor will accept payment in accordance with the following standards as compliance:

The contractor or subcontractor is required to furnish all employees with an adequate number of uniforms without cost or to reimburse employees for the actual cost of the uniforms. In addition, where uniform cleaning and maintenance is made the responsibility of the employee, all contractors and subcontractors subject to this wage determination shall (in the absence of a bona fide collective bargaining agreement providing for a different amount, or the furnishing of contrary affirmative proof as to the actual cost), reimburse all employees for such cleaning and maintenance at a rate of \$3.35 per week (or \$.67 cents per day). However, in those instances where the uniforms furnished are made of "wash and wear" materials, may be routinely washed and dried with other personal garments, and do not require any special treatment such as dry cleaning, daily washing, or commercial laundering in order to meet the cleanliness or appearance standards set by the terms of the Government contract, by the contractor, by law, or by the nature of the work, there is no requirement that employees be reimbursed for uniform maintenance costs.

DOL Wage Determination.pdf

** SERVICE CONTRACT ACT DIRECTORY OF OCCUPATIONS **

The duties of employees under job titles listed are those described in the "Service Contract Act Directory of Occupations", Fifth Edition (Revision 1), dated September 2015, unless otherwise indicated.

** REQUEST FOR AUTHORIZATION OF ADDITIONAL CLASSIFICATION AND WAGE RATE, Standard Form 1444 (SF-1444) **

Conformance Process:

The contracting officer shall require that any class of service employee which is not listed herein and which is to be employed under the contract (i.e., the work to be performed is not performed by any classification listed in the wage determination), be classified by the contractor so as to provide a reasonable relationship (i.e., appropriate level of skill comparison) between such unlisted classifications and the classifications listed in the wage determination (See 29 CFR 4.6(b)(2)(i)). Such conforming procedures shall be initiated by the contractor prior to the performance of contract work by such unlisted class(es) of employees (See 29 CFR 4.6(b)(2)(ii)). The Wage and Hour Division shall make a final determination of conformed classification, wage rate, and/or fringe benefits which shall be paid to all employees performing in the classification from the first day of work on which contract work is performed by them in the classification. Failure to pay such unlisted employees the compensation agreed upon by the interested parties and/or fully determined by the Wage and Hour Division retroactive to the date such class of employees commenced contract work shall be a violation of the Act and this contract. (See 29 CFR 4.6(b)(2)(v)). When multiple wage determinations are included in a contract, a separate SF-1444 should be prepared for each wage determination to which a class(es) is to be conformed.

The process for preparing a conformance request is as follows:

- 1) When preparing the bid, the contractor identifies the need for a conformed occupation(s) and computes a proposed rate(s).
- 2) After contract award, the contractor prepares a written report listing in order the proposed classification title(s), a Federal grade equivalency (FGE) for each proposed classification(s), job description(s), and rationale for proposed wage rate(s), including information regarding the agreement or disagreement of the authorized representative of the employees involved, or where there is no authorized representative, the employees themselves. This report should be submitted to the contracting officer no later than 30 days after such unlisted class(es) of employees performs any contract work.
- 3) The contracting officer reviews the proposed action and promptly submits a report of the action, together with the agency's recommendations and pertinent information including the position of the contractor and the employees, to the U.S. Department of Labor, Wage and Hour Division, for review (See 29 CFR 4.6(b)(2)(ii)).
- 4) Within 30 days of receipt, the Wage and Hour Division approves, modifies, or disapproves the action via transmittal to the agency contracting officer, or notifies the contracting officer that additional time will be required to process the request.
- 5) The contracting officer transmits the Wage and Hour Division's decision to the contractor.
- 6) Each affected employee shall be furnished by the contractor with a written copy of such determination or it shall be posted as a part of the wage determination (See 29 CFR 4.6(b)(2)(iii)).

Information required by the Regulations must be submitted on SF-1444 or bond paper.

DOL Wage Determination.pdf

When preparing a conformance request, the "Service Contract Act Directory of Occupations" should be used to compare job definitions to ensure that duties requested are not performed by a classification already listed in the wage determination. Remember, it is not the job title, but the required tasks that determine whether a class is included in an established wage determination. Conformances may not be used to artificially split, combine, or subdivide classifications listed in the wage determination (See 29 CFR 4.152(c)(1)).

AFFIDAVIT re CONTINGENT FEES

CITY OF _____)
) ss.
ISLAND OF GUAM)

_____[state name of affiant signing below], being first duly sworn, deposes and says that:

1. The name of the offering company or individual is [state name of company]
_____.

2. As a part of the offering company's bid or proposal, to the best of my knowledge, the offering company has not retained any person or agency on a percentage, commission, or other contingent arrangement to secure this contract. This statement is made pursuant to 2 GAR Division 4 11108(f).

3. As a part of the offering company's bid or proposal, to the best of my knowledge, the offering company has not retained a person to solicit or secure a contract with the government of Guam upon an agreement or understanding for a commission, percentage, brokerage, or contingent fee, except for retention of bona fide employees or bona fide established commercial selling agencies for the purpose of securing business. This statement is made pursuant to 2 GAR Division 4 11108(h).

4. I make these statements on behalf of myself as a representative of the offeror, and on behalf of the offeror's officers, representatives, agents, subcontractors, and employees.

Signature of one of the following:
Offeror, if the offeror is an individual;
Partner, if the offeror is a partnership;
Officer, if the offeror is a corporation.

Subscribed and sworn to before me

this ___ day of _____, 201__.

NOTARY PUBLIC
My commission expires _____, ____.

VOLUME 4
SAMPLE CONSTRUCTION AGREEMENT &
PERFORMANCE AND PAYMENT BOND FORM

**AGREEMENT
BETWEEN
JOSE D. LEON GUERRERO COMMERCIAL PORT
AND
CONTRACTOR**

THIS AGREEMENT (this "Agreement") is entered into by and between the JOSE D. LEON GUERRERO COMMERCIAL PORT, also known as the PORT AUTHORITY OF GUAM, a public corporation and autonomous instrumentality of the government of Guam, whose address is 1026 Cabras Highway, Suite 201, Piti, Guam 96925 (the "Port"), and (**Construction Company**) a Guam corporation authorized and licensed to do business in Guam, whose address is (**Business Address**) also known as ("Contractor"), with reference to the following facts:

RECITALS:

A. The Port previously issued an Invitation for Bid seeking construction work for the **Design build to supply and install steel and aluminum poles with led or solar lighting fixtures** under the **Invitation for Bid PAG-CIP-018-004**, a copy of which is attached to this Agreement as **EXHIBIT 1** and incorporated herein by this reference (the "IFB").

B. Pursuant to the IFB, the Port solicited sealed bids from qualified bidders for the Canopy Construction Project.

C. Contractor responded to the IFB by submitting a bid to provide the services described in the IFB, a copy of which is attached to this Agreement as **EXHIBIT 2** and incorporated herein by this reference (the "Bid"), and was selected by the Port as the lowest and most responsible and responsive qualified bidder.

D. The Port and Contractor have agreed to execute this Agreement in order to memorialize the terms and conditions on which Contractor shall provide the repairs and design/build services to the Port.

NOW, THEREFORE, the parties hereto, intending to be legally bound, do hereby agree as follows:

1. SERVICES TO BE PERFORMED

1.1 Scope of Work. Contractor shall provide the services identified in the IFB and the Bid. Contractor shall provide status reports on the services performed and required under this Agreement upon request by the Port. Contractor acknowledges and agrees that failure to promptly and satisfactorily perform all the services required under this Agreement constitutes a material breach of this Agreement.

1.2 Contractor Provisions of Resources. Contractor agrees to furnish all qualified personnel, facilities, tools, equipment, materials and transportation to perform the services and

work provided for in this Agreement. Contractor represents and warrants that it and its employees possess the professional and technical expertise and knowledge, resources and experience to perform the services described herein in a professional, skillful and diligent manner. The Port may, in its sole discretion, provide staff assistance to Contractor in furtherance of this Agreement. Contractor acknowledges and agrees that its employees, agents and all other personnel engaged to provide the services hereunder shall be informed of all relevant provisions of this Agreement.

1.3 Location of Services. Except as otherwise approved by the Port, the site for services rendered under this Agreement shall be the Port Authority of Guam, Cabras, Piti, Guam and the Port's property in the jurisdiction of Piti at the Port Authority of Guam Compound and Administrative Bldg.

1.4 Site Condition Contractor's Responsibility. Contractor accepts the conditions at the construction site as they eventually may be found to exist and warrants and represents that the services under this Agreement can and shall be performed under such conditions, and that all materials, equipment, labor and other facilities required because of any unforeseen conditions (physical or otherwise) shall be solely at Contractor's own cost and expense, anything in this Agreement to the contrary notwithstanding.

2. TERM OF AGREEMENT

2.1 Completion of Services. This Agreement shall be effective on the last signature date set forth on the signature page below, and shall continue until Contractor completes all services required hereunder unless earlier terminated in accordance with the terms of this Agreement. Contractor shall commence the performance of services required hereunder upon its receipt of a Notice to Proceed issued by the Port, and Contractor shall complete all required services under this Agreement within **Two Hundred Forty-Three Calendar Days (243)** from the issuance of a **Notice to Proceed by the Port.**

2.2 Liquidated Damages. Contractor acknowledges and agrees that any delays in the completion of the services required hereunder shall subject Contractor to liquidated damages. For each day beyond the expiration of the **Two Hundred and Forty-Three (243) days** period after the issuance of the Notice to Proceed, Contractor agrees to pay, not as a penalty but as liquidated damages, One Thousand Dollars and Zero Cents (\$1,000.00) per day to the Port. The parties agree that the foregoing amount is a reasonable amount for liquidated damages under the circumstances existing at the time this Agreement is entered into and constitutes a reasonable estimate of damages to the Port for any delays in the completion of services.

3. COMPENSATION

3.1 Compensation. In consideration for the services performed under this Agreement, the Port shall pay to Contractor an aggregate amount equal to (**DOLLAR AMOUNT \$_____**) in accordance with the terms and conditions set forth in this Agreement (the "Compensation"). The Compensation shall include any applicable Gross Receipts Tax.

3.2 Payment Terms

(a) **IFB.** The Port shall pay the Compensation to Contractor in accordance with the terms set forth in the IFB, and more specifically, the General Conditions section of the IFB.

(b) **Final Payment.** Final payment shall be made upon satisfactory performance of all services required to be performed by Contractor under this Agreement. Prior to the final payment due Contractor, and as a condition precedent thereto, Contractor shall execute and deliver to the Port a release in a form approved by the Port of claims against the Port arising under this Agreement. Contractor agrees to expressly waive the provision of section 82602 of Title 18, Guam Code Annotated, which states:

A general release does not extend to claims which the creditor does not know or suspect to exist in his favor at the time of executing the release, which if known by him must have materially affected his settlement with the debtor

3.3 Expenses. Contractor shall be solely responsible for all expenses incurred in the performance of services under this Agreement.

3.4 No Compensation Prior to Approval of Agreement. Contractor hereby waives any and all claims for any services performed by Contractor prior to (i) the full execution of this Agreement by all parties, and (ii) Contractor's receipt of a Notice to Proceed issued by the Port.

3.5 United States Currency. The Compensation payable to Contractor shall be in the currency of the United States.

4. TERMINATION OF AGREEMENT

4.1 By the Port - Termination for Convenience

(a) **Termination.** The Port may, when the interests of this territory so require, terminate this Agreement in whole or in part, for the convenience of the territory. The Port shall give written notice of the termination to Contractor specifying the part of this Agreement terminated and when termination becomes effective.

(b) **Contractor's Obligations.** Contractor shall incur no further obligations in connection with the terminated services and on the date set in the notice of termination Contractor shall stop services to the extent specified. Contractor shall also terminate outstanding orders and subcontracts as they relate to the terminated services. Contractor shall settle the liabilities and claims arising out of the termination of subcontracts and orders connected with the terminated services. The Port may direct Contractor to assign Contractor's right, title, and interest under terminated orders or subcontracts to the Port. Contractor must still complete the services not terminated by the notice of termination and may incur obligations as necessary to do so.

(c) **Right to Construction and Supplies.** The Port may require Contractor to transfer title and deliver to the Port in the manner and to the extent directed by the Port:

(i) any completed construction; and

(ii) such partially completed construction, supplies, materials, parts, tools, dies, jigs, fixtures, plans, drawing, information, and agreement rights (hereinafter called "construction material") as Contractor has specifically produced or specially acquired for the performance of the terminated part of this Agreement. Contractor shall protect and preserve property in the possession of Contractor in which the Port has an interest. If the Port does not exercise its rights under this Section 4.1(c), Contractor shall use its best efforts to sell such construction, supplies, and construction materials in accordance with the standards set forth in 13 G.C.A. §2706. Contractor acknowledges and agrees that the exercise by the Port of its rights under this Section 4.1 shall not be deemed to be a breach of this Agreement.

(d) Compensation

(i) Contractor shall submit a termination claim specifying the amounts due because of the termination for convenience together with cost or pricing data, submitted to the extent required by section 3118 (Cost or Pricing Data) of the Guam Procurement Regulations, bearing on such claim. If Contractor fails to file a termination claim within one year from the effective date of termination, the Port may pay Contractor, if at all, an amount set in accordance with Section 4.1(d)(iii), below.

(ii) The Port and Contractor may agree to a settlement provided the Contractor has filed a termination claim supported by cost or pricing data submitted as required by §3118 (Cost or Pricing Data) of the Guam Procurement Regulations and that the settlement does not exceed (x) the Compensation under this Agreement, plus reasonable settlement costs, less (y) any payments previously made by the Port, the proceeds of any sales of construction, supplies, and construction materials under Section 4.1(c), above, and the portion of Compensation remaining for services not terminated.

(iii) Absent complete agreement under Section 4.1(d)(ii), above, the Port shall pay Contractor the following amounts with respect to all services performed prior to the effective date of the notice of termination, provided that payments shall not be duplicated for any items set forth below pursuant to any other provision of this Agreement:

(A) the cost of such services plus a fair and reasonable profit on such portion of the services (such profit shall not include anticipatory profit or consequential damages) less amounts paid or to be paid for completed portions of such services; provided, however, that if it appears that Contractor would have sustained a loss if the services would have been completed under this Agreement, no profit shall be allowed or included and the amount of compensation shall be reduced to reflect the anticipated rate of loss;

(B) the cost of settling and paying claims arising out of the termination of subcontracts or orders pursuant to Section 4.1(b), above. These costs must not include costs paid in accordance with Section 4.1(d)(iii)(A), above.

(C) the reasonable settlement costs of Contractor including accounting, legal, clerical, and other expenses reasonably necessary for the preparation of settlement claims and supporting data with respect to the terminated portion of this Agreement

and for the termination and settlement of subcontracts thereunder, together with reasonable storage, transportation, and other costs incurred in connection with the protection or disposition of property allocable to the terminated portion of this Agreement. The total sum to be paid to Contractor under this Section 4.1(d)(iii) shall not exceed (x) the Compensation under this Agreement, plus settlement costs, *less* (y) any payments previously made by the Port, the proceeds of any sales of construction, supplies, and construction materials under Section 4.1(c), above, and the portion of Compensation remaining for services not terminated.

(iv) Cost claimed, agreed to, or established under Section 4.1(d)(ii) and (iii) shall be in accordance with Chapter 7 (Cost Principles) of the Guam Procurement Regulations.

4.2 By the Port - Termination for Default

(a) Default. If Contractor refuses or fails to perform the services, or any separable part thereof, with such diligence as will assure its completion within the time specified in this Agreement, or any extension thereof, or fails to complete the services within such time, or commits any other substantial breach of this Agreement, and further fails within fourteen (14) days after receipt of written notice from the Port to cure such default or to commence and continue correction of such refusal within such other time provided by the Port in writing, the Port may, by written notice to Contractor, declare Contractor in breach and terminate this Agreement or any portion thereof. In such event the Port may take over the responsibility of performing the services and prosecute the same to completion, by contract or otherwise, and may take possession of, and utilize in completing the services, such materials, appliances, and plant as may be on the site of the services and necessary therefor. Whether or not Contractor's right to proceed with the services is terminated, Contractor and Contractor's sureties shall be liable for any damage to the Port resulting from Contractor's refusal or failure to complete the services within the specified time.

(b) Liquidated Damages upon Termination. If fixed and agreed liquidated damages are provided in this Agreement, and if the Port terminates Contractor's right to proceed, the resulting damage shall consist of such liquidated damages for such reasonable time as may be required for final completion of the services required hereunder.

(c) Liquidated Damages in Absence of Termination. If fixed and agreed liquidated damages are provided in this Agreement, and if the Port does not terminate Contractor's right to proceed, the resulting damage will consist of such liquidated damages until the services required hereunder are completed.

(d) Time Extension. Contractor's right to proceed shall not be so terminated nor Contractor charged with resulting damage if:

(i) the delay in the completion of the services arises from causes such as: acts of God; acts of the public enemy; acts of the territory, and any other territorial entity in either a sovereign or contractual capacity; acts of another contractor in the performance of a contract with the Port; fires; floods; epidemics; quarantine restrictions; strikes or other labor disputes; freight embargoes; unusually severe weather; delays of subcontractors due to causes similar to those set forth above; or shortage of materials; provided, however, that no extension of time will be granted for a delay caused by a shortage of materials, unless Contractor furnished to Port proof

that Contractor has diligently made every effort to obtain such materials from all known sources within reasonable reach, and further proof that the inability to obtain such materials when originally planned did in fact cause a delay in final completion of the entire services which could not be compensated for by revising the sequence of Contractor's operations; and

(ii) Contractor, within ten (10) days from the beginning of any such delay (unless the Port grants a further period of time before the date of final payment under this Agreement), notifies the Port in writing of the causes of delay. The Port shall ascertain the facts and the extent of the delay and extend the time for completing the services when, in the judgment of the Port, the findings of fact justify such an extension.

(e) Erroneous Termination for Default. If, after notice of termination of the Contractor's right to proceed under the provisions of this Section 4.2, it is determined for any reason that Contractor was not in default under the provisions of this Section 4.2, or that the delay was excusable under the provisions of this Section 4.2, the rights and obligations of the parties shall be the same as if the notice of termination had been issued pursuant to the Port's exercise of a termination for convenience under Section 4.1, above.

(f) Additional Rights and Remedies. The rights and remedies of the Port provided in this Section 4.2 shall be in addition to any other rights and remedies provided by law or under this Agreement.

4.3 Termination/Modification for Lack of Funds. The Port may terminate or modify this Agreement based upon a lack of funding. In such an event, the Port shall promptly provide notice to Contractor and within twenty (20) days of the notice, the parties shall renegotiate the terms of this Agreement in good faith. If the parties are unable to reach an agreement on the renegotiation, then either Party may terminate this Agreement pursuant to other provisions of this Section 4, as applicable.

4.4 By Contractor - Termination for Cause. Contractor may elect to terminate this Agreement at any time for Cause, effective upon delivery of written notice of termination. For purposes of this Section 4.4, "Cause" shall mean the Port's failing to perform the duties and obligations imposed upon the Port hereunder and failing to cure such breach within twenty (20) days following delivery to the Port of written notice specifying the failures to perform, or, if such default cannot reasonably be remedied within such 20-day period, the Port fails to commence and diligently pursue remedial action within such 20-day period or fails to cure such default within sixty (60) days following delivery to the Port of written notice specifying the failures to perform. Upon the termination of this Agreement in accordance with this Section 4.4, the Port shall be obligated to pay Contractor for the portion of Compensation accrued and payable with respect to the satisfactory performance of services for the period ending on the effective date of termination.

4.5 Preservation of Property. Notwithstanding any termination of this Agreement, and subject to any directions from the Port, Contractor shall take timely and reasonable and necessary action to protect and preserve the property in the possession of Contractor in which the Port has an interest.

4.6 Additional Provisions. The termination of this Agreement by any party pursuant to

the provisions of this Section 4 shall not constitute, or be deemed to constitute, the waiver or release by such party of any rights or claims such party may have against the other party by reason of actions or omissions occurring on or before the effective date of termination. The parties acknowledge and agree that in the event of termination, the Port may issue a new Invitation for Bids with respect to such terminated services.

5. CONTACT PERSON.

Contractor agrees that, during the term of this Agreement, it shall identify a primary contact person who is familiar with the services being performed hereunder and who shall be responsible for responding to the questions and direction of the Port. The contact person must be identified in writing within five (5) days after full execution of this Agreement by all parties. The Port reserves the right to request replacement of the contact person designated by Contractor under this Agreement.

6. CONFIDENTIALITY

6.1 Confidential Information. Contractor hereby warrants that it shall not disclose any documents, materials or information, whether verbal, written, recorded magnetic media or otherwise (collectively, the "Confidential Information"), made available or acquired for the purpose of carrying out this Agreement. Only authorized persons shall use and have access to the Confidential Information, and then only for the period such access is required to perform services under this Agreement. All necessary steps shall be taken by Contractor to safeguard the confidentiality of the Confidential Information in conformance with the terms of this Agreement and any applicable federal and local laws, statutes and regulations.

(a) The obligations under this Section 6 shall survive termination of this Agreement. Upon termination of this Agreement, all Confidential Information shall be returned promptly to the Port and all copies or derivations of the Confidential Information shall be physically and/or electronically destroyed. Contractor shall include a letter attesting to the return of Confidential Information and documenting the destruction of copies and derivations with the returned Confidential Information.

(b) Contractor shall not enter into any agreements or discussions with a third party concerning the Confidential Information without the prior written consent of the Port, and then only if Contractor requires the third party to agree to the terms of this Section 6 and the Confidential Information is provided to such third party only for purposes of enabling Contractor to discharge its responsibilities under this Agreement.

(c) The confidentiality obligations set forth in this Section 6 shall not apply (i) to the extent required by applicable law, (ii) to the extent that any Confidential Information is now or hereafter becomes part of the public domain, but only to the limited extent that such Confidential Information, or any portion thereof, is in the public domain not as a result of any breach or violation of this Agreement, or (iii) to the extent that a party is directed otherwise under the terms of a valid and effective order issued by a court of competent jurisdiction.

6.2 Equitable Relief. Contractor (a) acknowledges that any violation of the provisions of this Section 6 may cause to the Port immediate and irreparable damage for which the Port cannot be adequately compensated by monetary damages, (b) therefore agrees that in the event of any such breach, the Port shall be entitled to such preliminary or other injunctive relief, an order for specific performance, and any other equitable relief as a court may determine to be appropriate, (c) hereby waives any requirement that the Port post, as a condition or other requirement of obtaining any such equitable relief, a bond or other collateral, and (d) further agrees that such equitable relief shall be in addition to any damages or other remedies provided by law and otherwise available to the Port by reason of Contractor's breach.

7. CONFLICTS OF INTERESTS; ETHICS

7.1 Contractor warrants and covenants that it has not violated and will not violate Guam's procurement law or regulations pertaining to ethics in public contracting.

7.2 Notwithstanding any other provision in this Agreement, Contractor acknowledges and agrees that any breach by Contractor of the covenants or warranties in this Section 7 shall be deemed a material breach of this Agreement and shall entitle the Port to immediately terminate this Agreement without liability.

8. COMPLIANCE WITH LAWS

8.1 General. Contractor shall comply with all applicable federal and local laws, statutes, regulations and ordinances with respect to this Agreement. Contractor represents and warrants that it is fully licensed to do business in Guam to render the services to be provided herein.

8.2 Non-Discrimination in Employment. Contractor agrees (i) not to unlawfully discriminate in any manner against an employee or applicant for employment because of race, color, religion, creed, age, sex, marital status, national origin, ancestry, or physical or mental handicap, and (ii) to post and to cause any subcontractor to post in a conspicuous place available to employees and applicants for employment, a notice setting forth the substance of clause (i), above.

8.3 Davis Bacon Requirements

8.3.1 Minimum Wages

8.3.1.1. All laborers and mechanics employed or working upon the site of the work (or under the United States Housing Act of 1937 or under the Housing Act of 1949 in the construction or development of the project), will be paid unconditionally and not less often than once a week, and without subsequent deduction or rebate on any account (except such payroll deductions as are permitted by regulations issued by the Secretary of Labor under the Copeland Act (29 CFR part 3)), the full amount of wages and bona fide fringe benefits (or cash equivalents thereof) due at time of payment computed at rates not less than those contained in the wage determination of the Secretary of Labor which is attached hereto and made a part hereof, regardless of any contractual relationship which may be alleged to exist between the contractor and such laborers and mechanics.

Contributions made or costs reasonably anticipated for bona fide fringe benefits under section 1(b)(2) of the Davis-Bacon Act on behalf of laborers or mechanics are considered wages paid to such laborers or mechanics, subject to the provisions of paragraph (a)(1)(iv) of this section; also, regular contributions made or costs incurred for more than a weekly period (but not less often than quarterly) under plans, funds, or programs which cover the particular weekly period, are deemed to be constructively made or incurred during such weekly period. Such laborers and mechanics shall be paid the appropriate wage rate and fringe benefits on the wage determination for the classification of work actually performed, without regard to skill, except as provided in Sec. 5.5(a)(4). Laborers or mechanics performing work in more than one classification may be compensated at the rate specified for each classification for the time actually worked therein: Provided that the employer's payroll records accurately set forth the time spent in each classification in which work is performed. The wage determination (including any additional classification and wage rates conformed under paragraph (a)(1)(ii) of this section) and the Davis-Bacon poster (WH-1321) shall be posted at all times by the contractor and its subcontractors at the site of the work in a prominent and accessible place where it can be easily seen by the workers.

8.3.1.2 (A) The Port shall require that any class of laborers or mechanics, including helpers, which is not listed in the wage determination and which is to be employed under the contract shall be classified in conformance with the wage determination. The Port shall approve an additional classification and wage rate and fringe benefits therefore only when the following criteria have been met:

- (1) The work to be performed by the classification requested is not performed by a classification in the wage determination; and
- (2) The classification is utilized in the area by the construction industry; and
- (3) The proposed wage rate, including any bona fide fringe benefits, bears a reasonable relationship to the wage rates contained in the wage determination.

8.3.1.2 (B) If the contractor and the laborers and mechanics to be employed in the classification (if known), or their representatives, and the Port agree on the classification and wage rate (including the amount designated for fringe benefits where appropriate), a report of the action taken shall be sent by the Port to the Administrator of the Wage and Hour Division, Employment Standards Administration, U.S. Department of Labor, Washington, DC 20210. The Administrator, or an authorized representative, will approve, modify, or disapprove every additional classification action within 30 days of receipt and so advise the Port or will notify the Port within the 30-day period that additional time is necessary.

8.3.1.2 (C) In the event the contractor, the laborers or mechanics to be employed in the classification or their representatives, and the Port do not agree on the proposed classification and wage rate (including the amount designated for fringe benefits, where appropriate), the Port shall refer the questions, including the views of all interested parties and the recommendation of

the Port, to the Administrator for determination. The Administrator, or an authorized representative, will issue a determination within 30 days of receipt and so advise the Port or will notify the Port within the 30-day period that additional time is necessary.

8.3.1.2 (D) The wage rate (including fringe benefits where appropriate) determined pursuant to paragraphs (a)(1)(ii) (B) or (C) of this section, shall be paid to all workers performing work in the classification under this contract from the first day on which work is performed in the classification.

8.3.1.3. Whenever the minimum wage rate prescribed in the contract for a class of laborers or mechanics includes a fringe benefit which is not expressed as an hourly rate, the contractor shall either pay the benefit as stated in the wage determination or shall pay another bona fide fringe benefit or an hourly cash equivalent thereof.

8.3.1.4. If the contractor does not make payments to a trustee or other third person, the contractor may consider as part of the wages of any laborer or mechanic the amount of any costs reasonably anticipated in providing bona fide fringe benefits under a plan or program, Provided, That the Secretary of Labor has found, upon the written request of the contractor, that the applicable standards of the Davis-Bacon Act have been met. The Secretary of Labor may require the contractor to set aside in a separate account asset for the meeting of obligations under the plan or program.

8.3.2. Withholding. The Port shall upon its own action or upon written request of an authorized representative of the Department of Labor withhold or cause to be withheld from the contractor under this contract or any other Federal contract with the same prime contractor, or any other federally- assisted contract subject to Davis-Bacon prevailing wage requirements, which is held by the same prime contractor, so much of the accrued payments or advances as may be considered necessary to pay laborers and mechanics, including apprentices, trainees, and helpers, employed by the contractor or any subcontractor the full amount of wages required by the contract. In the event of failure to pay any laborer or mechanic, including any apprentice, trainee, or helper, employed or working on the site of the work (or under the United States Housing Act of 1937 or under the Housing Act of 1949 in the construction or development of the project), all or part of the wages required by the contract, the Port may, after written notice to the contractor, sponsor, applicant, or owner, take such action as may be necessary to cause the suspension of any further payment, advance, or guarantee of funds until such violations have ceased.

8.3.3 Payrolls and Basic Records.

8.3.3.1. Payrolls and basic records relating thereto shall be maintained by the contractor during the course of the work and preserved for a period of three years thereafter for all laborers and mechanics working at the site of the work (or under the United States Housing Act of 1937, or under the Housing Act of 1949, in the construction or development of the project). Such records shall contain the name, address, and social security number of each such worker, his or her correct classification, hourly rates of wages paid (including rates of contributions or costs anticipated for bona fide fringe benefits or cash equivalents thereof of the types described in section 1(b)(2)(B) of the Davis-Bacon Act), daily and weekly number of hours worked, deductions

made and actual wages paid. Whenever the Secretary of Labor has found under 29 CFR 5.5(a)(1)(iv) that the wages of any laborer or mechanic include the amount of any costs reasonably anticipated in providing benefits under a plan or program described in section 1(b)(2)(B) of the Davis-Bacon Act, the contractor shall maintain records which show that the commitment to provide such benefits is enforceable, that the plan or program is financially responsible, and that the plan or program has been communicated in writing to the laborers or mechanics affected, and records which show the costs anticipated or the actual cost incurred in providing such benefits. Contractors employing apprentices or trainees under approved programs shall maintain written evidence of the registration of apprenticeship programs and certification of trainee programs, the registration of the apprentices and trainees, and the ratios and wage rates prescribed in the applicable programs.

8.3.3.2 (A) The contractor shall submit weekly for each week in which any contract work is performed a copy of all payrolls to the Port if the agency is a party to the contract, but if the agency is not such a party, the contractor will submit the payrolls to the applicant, sponsor, or owner, as the case may be, for transmission to the Port. The payrolls submitted shall set out accurately and completely all of the information required to be maintained under 29 CFR 5.5(a)(3)(i), except that full social security numbers and home addresses shall not be included on weekly transmittals. Instead the payrolls shall only need to include an individually identifying number for each employee (e.g., the last four digits of the employee's social security number). The required weekly payroll information may be submitted in any form desired. Optional Form WH-347 is available for this purpose from the Wage and Hour Division Web site at <http://www.dol.gov/esa/whd/forms/wh347instr.htm> or its successor site.

The prime contractor is responsible for the submission of copies of payrolls by all subcontractors. Contractors and subcontractors shall maintain the full social security number and current address of each covered worker, and shall provide them upon request to the Port if the agency is a party to the contract, but if the agency is not such a party, the contractor will submit them to the applicant, sponsor, or owner, as the case may be, for transmission to the Port, the contractor, or the Wage and Hour Division of the Department of Labor for purposes of an investigation or audit of compliance with prevailing wage requirements. It is not a violation of this section for a prime contractor to require a subcontractor to provide addresses and social security numbers to the prime contractor for its own records, without weekly submission to the sponsoring government agency (or the applicant, sponsor, or owner).

8.3.3.2 (B) Each payroll submitted shall be accompanied by a "Statement of Compliance," signed by the contractor or subcontractor or his or her agent who pays or supervises the payment of the persons employed under the contract and shall certify the following:

8.3.3.2 (B).1 That the payroll for the payroll period contains the information required to be provided under Sec. 5.5 (a)(3)(ii) of Regulations, 29 CFR part 5, the appropriate information is being maintained under Sec. 5.5 (a)(3)(i) of Regulations, 29 CFR part 5, and that such information is correct and complete;

8.3.3.2 (B).2 That each laborer or mechanic (including each helper, apprentice, and trainee) employed on the contract during the payroll period has been paid the full weekly wages earned, without rebate, either directly or indirectly, and that no deductions have been made either

directly or indirectly from the full wages earned, other than permissible deductions as set forth in Regulations, 29 CFR part 3;

8.3.3.2 (B).3 That each laborer or mechanic has been paid not less than the applicable wage rates and fringe benefits or cash equivalents for the classification of work performed, as specified in the applicable wage determination incorporated into the contract.

8.3.3.2 (C) The weekly submission of a properly executed certification set forth on the reverse side of Optional Form WH-347 shall satisfy the requirement for submission of the "Statement of Compliance" required by paragraph 8.3.3.2(B) of this section.

8.3.3.2(D) The falsification of any of the above certifications may subject the contractor or subcontractor to civil or criminal prosecution under section 1001 of title 18 and section 231 of title 31 of the United States Code.

8.3.3.3 The contractor or subcontractor shall make the records required under paragraph 8.3.3 of this section available for inspection, copying, or transcription by authorized representatives of the Port or the Department of Labor, and shall permit such representatives to interview employees during working hours on the job. If the contractor or subcontractor fails to submit the required records or to make them available, the Federal agency may, after written notice to the contractor, sponsor, applicant, or owner, take such action as may be necessary to cause the suspension of any further payment, advance, or guarantee of funds. Furthermore, failure to submit the required records upon request or to make such records available may be grounds for debarment action pursuant to 29 CFR 5.12.

8.3.4. Apprentices and trainees

8.3.4.1 Apprentices. Apprentices will be permitted to work at less than the predetermined rate for the work they performed when they are employed pursuant to and individually registered in a bona fide apprenticeship program registered with the U.S. Department of Labor, Employment and Training Administration, Office of Apprenticeship Training, Employer and Labor Services, or with a State Apprenticeship Agency recognized by the Office, or if a person is employed in his or her first 90 days of probationary employment as an apprentice in such an apprenticeship program, who is not individually registered in the program, but who has been certified by the Office of Apprenticeship Training, Employer and Labor Services or a State Apprenticeship Agency (where appropriate) to be eligible for probationary employment as an apprentice. The allowable ratio of apprentices to journeymen on the job site in any craft classification shall not be greater than the ratio permitted to the contractor as to the entire work force under the registered program. Any worker listed on a payroll at an apprentice wage rate, who is not registered or otherwise employed as stated above, shall be paid not less than the applicable wage rate on the wage determination for the classification of work actually performed. In addition, any apprentice performing work on the job site in excess of the ratio permitted under the registered program shall be paid not less than the applicable wage rate on the wage determination for the work actually performed. Where a contractor is performing construction on a project in a locality other than that in which its program is registered, the ratios and wage rates (expressed in percentages of the journeyman's hourly rate) specified in the contractor's or

subcontractor's registered program shall be observed. Every apprentice must be paid at not less than the rate specified in the registered program for the apprentice's level of progress, expressed as a percentage of the journeymen hourly rate specified in the applicable wage determination. Apprentices shall be paid fringe benefits in accordance with the provisions of the apprenticeship program. If the apprenticeship program does not specify fringe benefits, apprentices must be paid the full amount of fringe benefits listed on the wage determination for the applicable classification. If the Administrator determines that a different practice prevails for the applicable apprentice classification, fringes shall be paid in accordance with that determination. In the event the Office of Apprenticeship Training, Employer and Labor Services, or a State Apprenticeship Agency recognized by the Office, withdraws approval of an apprenticeship program, the contractor will no longer be permitted to utilize apprentices at less than the applicable predetermined rate for the work performed until an acceptable program is approved.

8.3.4.2 Trainees. Except as provided in 29 CFR 5.16, trainees will not be permitted to work at less than the predetermined rate for the work performed unless they are employed pursuant to and individually registered in a program which has received prior approval, evidenced by formal certification by the U.S. Department of Labor, Employment and Training Administration. The ratio of trainees to journeymen on the job site shall not be greater than permitted under the plan approved by the Employment and Training Administration. Every trainee must be paid at not less than the rate specified in the approved program for the trainee's level of progress, expressed as a percentage of the journeyman hourly rate specified in the applicable wage determination. Trainees shall be paid fringe benefits in accordance with the provisions of the trainee program. If the trainee program does not mention fringe benefits, trainees shall be paid the full amount of fringe benefits listed on the wage determination unless the Administrator of the Wage and Hour Division determines that there is an apprenticeship program associated with the corresponding journeyman wage rate on the wage determination which provides for less than full fringe benefits for apprentices. Any employee listed on the payroll at a trainee rate who is not registered and participating in a training plan approved by the Employment and Training Administration shall be paid not less than the applicable wage rate on the wage determination for the classification of work actually performed. In addition, any trainee performing work on the job site in excess of the ratio permitted under the registered program shall be paid not less than the applicable wage rate on the wage determination for the work actually performed. In the event the Employment and Training Administration withdraws approval of a training program, the contractor will no longer be permitted to utilize trainees at less than the applicable predetermined rate for the work performed until an acceptable program is approved.

8.3.4.3 Equal Employment Opportunity. The utilization of apprentices, trainees and journeymen under this part shall be in conformity with the equal employment opportunity requirements of Executive Order 11246, as amended, and 29 CFR part 30.

8.3.5 Compliance With Copeland Act Requirements. The contractor shall comply with the requirements of 29 CFR Part 3, which are incorporated by reference in this contract.

8.3.6 Subcontracts. The contractor or subcontractor shall insert in any subcontracts the clauses contained in 29 CFR Part 5.5(a)(1) through (10) and such other clauses as **the Port** may by appropriate instructions require, and also a clause requiring the subcontractors to include these clauses in any lower tier subcontracts. The prime contractor shall be responsible for the

compliance by any subcontractor or lower tier subcontractor with all the contract clauses in 29 CFR Part 5.5.

8.3.7. Contract Termination: Debarment. A breach of the contract clauses in paragraph 1 through 10 of this section may be grounds for termination of the contract, and for debarment as a contractor and a subcontractor as provided in 29 CFR 5.12.

8.3.7. Compliance With Davis-Bacon and Related Act Requirements. All rulings and interpretations of the Davis-Bacon and Related Acts contained in 29 CFR Parts 1, 3, and 5 are herein incorporated by reference in this contract.

8.3.8. Disputes Concerning Labor Standards. Disputes arising out of the labor standards provisions of this contract shall not be subject to the general disputes clause of this contract. Such disputes shall be resolved in accordance with the procedures of the Department of Labor set forth in 29 CFR Parts 5, 6 and 7. Disputes within the meaning of this clause include disputes between the contractor (or any of its subcontractors) and the contracting agency, the U.S. Department of Labor, or the employees or their representatives.

8.3.9. Certification of Eligibility.

8.3.9.1. By entering into this contract, the contractor certifies that neither it (nor he or she) nor any person or firm who has an interest in the contractor's firm is a person or firm ineligible to be awarded Government contracts by virtue of section 3(a) of the Davis-Bacon Act or 29 CFR 5.12(a)(1).

8.3.9.2. No part of this contract shall be subcontracted to any person or firm ineligible for award of a Government contract by virtue of section 3(a) of the Davis-Bacon Act or 29 CFR 5.12(a)(1).

8.3.9.3. The penalty for making false statements is prescribed in the U.S. Criminal Code, 18 U.S.C. 1001.

9. Prohibition Against Gratuities and Kickbacks

A. **Gratuities.** It shall be a breach of ethical standards for any person to offer, give, or agree to give any employee or former employee, or for any employee or former employee, to solicit, demand, accept, or agree to accept from another person, a gratuity or an offer of employment in connection with any decision, approval, disapproval, recommendation, preparation of any part of a program requirement or a purchase request, influencing the content of any specification or procurement standard, rendering of advice, investigation, auditing, or in any other advisory capacity in any proceeding or application, request for ruling, determination, claim or controversy or other particular matter, pertaining to any program requirement or a contract or subcontract, or to any solicitation or proposal therefor.

- B. Kickbacks. It shall be a breach of ethical standards for any payment, gratuity, or offer of employment to be made by or on behalf of a subcontractor under a contract to the prime contractor or higher tier subcontractor or any person associated therewith, as an inducement of the award of a subcontract or order.

10. RETENTION AND ACCESS TO RECORDS AND OTHER REVIEW. Contractor, including subcontractors, if any, shall maintain all books, documents, papers, accounting records and other evidence pertaining to the services performed and costs incurred, and shall make such materials available at its respective offices at all reasonable times for inspection by the Port for the period ending six (6) years following the expiration or termination of this Agreement. The Port agrees to comply with Contractor's reasonable requests for access to all documents and Port property reasonably necessary to the performance of Contractor's services under this Agreement.

11. INDEMNIFICATION

11.1 Indemnification. Contractor shall indemnify and hold the Port and each of its officers, agents, Board members and employees, harmless from and against all claims, losses, expenses, injuries, damages, actions, lawsuits, judgments, and all other liabilities, including reasonable attorneys' fees for the defense thereof, arising from or relating to (i) Contractor's breach or failure to perform any of its obligations under this Agreement, (ii) the inaccuracy of any representation or warranty of Contractor under this Agreement, (iii) any violation of or noncompliance with any federal or local law or regulation by Contractor, or (iv) any act or omission of Contractor or its employees, officers, directors, contractors, agents, representatives, successors, or assigns, in the performance or nonperformance of services under this Agreement.

11.2 No Liability. The Port assumes no liability for any accident, loss, claim, judgment, action or injury that may occur with respect to Contractor, Contractor's officers, directors, agents, servants, subcontractors or employees, or to the personal property of any such person or entity, arising out of the performance of services under this Agreement except to the extent caused by the willful misconduct of the Port. No Board member, officer, agent, or employee of the Port shall be personally liable to Contractor under or by reason of this Agreement or any of its provisions.

12. SUSPENSION OF WORK

12.1 Suspension for Convenience. The Port may order Contractor in writing to suspend, delay, or interrupt all or any part of the work for such period of time as the Port may determine to be appropriate for the convenience of the territory.

12.2 Adjustment of Cost. If the performance of all or any part of the work is, for an unreasonable period of time, suspended, delayed, or interrupted by an act of Port in the administration of this Agreement, or by the failure of the Port to act within the time specified in this Agreement (or if no time is specified, within reasonable time), an adjustment shall be made for any increase in the cost of performance of this Agreement necessarily caused by such unreasonable suspension, delay, or interruption and this Agreement modified in writing accordingly. However, no adjustment shall be made under this clause for any suspension, delay, or interruption to the extent:

(a) that performance would have been so suspended, delayed, or interrupted by any other cause, including the fault or negligence of Contractor; or

(b) such adjustment is provided for or excluded under any other provision of this Agreement.

12.3 Time Restriction on Claim. No claim under this Section 11 shall be allowed:

(a) for any costs incurred more than twenty (20) days before Contractor shall have notified the Port in writing of the act or failure to act involved (but this requirement shall not apply as to a claim resulting from a suspension order); and

(b) unless the claim is asserted in writing as soon as practicable after the termination of such suspension, delay, or interruption, but not later than the date of final payment under the contract.

12.4 Adjustments of Price. Any adjustment in the Compensation payable under this Agreement made pursuant to this Section 11 shall be determined in accordance with Section 12, below.

13. PRICE ADJUSTMENT

13.1 Price Adjustment Methods. Any adjustment pursuant to the terms of this Agreement in the Compensation payable under this Agreement, shall be made in one or more of the following ways:

(a) by agreement on a fixed price adjustment before commencement of the pertinent performance or as soon thereafter as practicable;

(b) by unit prices specified in this Agreement or subsequently agreed upon;

(c) by the costs attributable to the event or situation covered by the applicable clause or provision, plus appropriate profit or fee, all as specified in this Agreement or subsequently agreed upon;

(d) in such other manner as the parties may mutually agree; or

(e) in the absence of an agreement between the parties, by a unilateral determination by the Port of costs attributable to the event or situation covered by the clause or provision, plus appropriate profit or fee, all as computed by the Port in accordance with generally accepted accounting principles and applicable provisions under Chapter 7 (Cost Principles) of the Guam Procurement Regulations and subject to the provisions of Article 5, Chapter 5 of 5 G.C.A. (Legal and Contractual Remedies) of the Guam Procurement Act.

13.2 Submission of Cost or Pricing Data. Contractor shall submit cost or pricing data for any price adjustments subject to the provisions of §3118 (Cost or Pricing Data) of the Guam Procurement Regulations.

14. DISPUTES

14.1 All controversies between the Port and Consultant which arise under, or are by virtue of, this Agreement and which are not resolved by mutual agreement, shall be decided by the Procurement Officer in writing, within 60 days after written request by Consultant for a final decision concerning the controversy; provided, however, that if the Procurement Officer does not issue a written decision, within 60 days after written request for a final decision, or within such longer period as may be agreed upon by the Parties, then Consultant may proceed as if a decision adverse to the Port had been received.

14.2 The Procurement Officer shall immediately furnish a copy of the decision to Consultant, by certified mail, return receipt requested, or by any other method that provides evidence of receipt.

14.3 Any such decision shall be final and conclusive, unless fraudulent, or Consultant brings an action appealing the decision to the Office of Public Auditor. Either party shall have the right to appeal an adverse decision by the Public Auditor to the Superior Court of Guam as provided in 5 GCA Section 5707.

14.4 Contractor shall comply with any decision of the Procurement Officer and proceed diligently with performance of this Agreement pending final resolution by the Superior Court of Guam of any controversy arising under, or by virtue of, this Agreement, except where there has been a material breach of the contract by the Port; provided, however, that in any event Contractor shall proceed diligently with the performance of the contract where the Chief Procurement Officer, the Director of Public Works, or the head of a Purchasing Agency has made a written determination that continuation of work under this Agreement is essential to the public health and safety.

15. CLAIMS BASED ON PORT ACTIONS OR OMISSIONS

15.1 Notice of Claim. If any action or omission on the part of the Port requiring performance changes within the scope of this Agreement constitutes the basis for a claim by Contractor for additional compensation, damages, or an extension of time for completion, Contractor shall continue with performance of this Agreement in compliance with the directions or orders of the Port, but by so doing, Contractor shall not be deemed to have prejudiced any claim for additional compensation, damages, or an extension of time for completion; provided:

(a) Contractor shall have given written notice to the Port:

(i) prior to the commencement of the services involved, if at that time the contractor knows of the occurrence of such action or omission;

(ii) within 30 days after Contractor knows of the occurrence of such action or omission, if Contractor did not have such knowledge prior to the commencement of the services; or

(iii) within such further time as may be allowed by the Port in writing.

The notice shall state that Contractor regards the act or omission as a reason which may entitle Contractor to additional compensation, damages, or an extension of time. The Port, upon receipt of such notice, may rescind such action, remedy such omission, or take such other steps as may be deemed advisable in the discretion of the Port.

(b) The notice required by Section 13.1(a), above, describes as clearly as practicable at the time the reasons why Contractor believes that additional compensation, damages, or an extension of time may be remedies to which Contractor is entitled; and

(c) Contractor maintains and, upon request, makes available to the Port within a reasonable time, detailed records to the extent practicable, of the claimed additional costs or basis for an extension of time in connection with such changes.

15.2 Limitations of Clause. Nothing in this Section 13, however, shall excuse Contractor from compliance with any rules of law precluding any territorial officers and any contractors from acting in collusion or bad faith in issuing or performing change orders which are clearly not within the scope of this Agreement.

15.3 Adjustments of Price. Any adjustment in the Compensation payable under this Agreement made pursuant to this Section 13 shall be determined in accordance with Section 12, above.

16. MODIFICATIONS INCLUDING THOSE DUE TO PUBLIC WELFARE, CHANGE IN LAW OR CHANGE IN MARKETING CONDITIONS. The Port shall have the unilateral power to modify this Agreement at any time subject to the written agreement of Contractor. The Port shall have the power to make changes in this Agreement and to impose new rules and regulations on Contractor under this Agreement relative to the scope and methods of providing services as shall from time-to-time be necessary and desirable for the public welfare or due to a change in law. The Port shall give Contractor notice of any proposed change in this Agreement and an opportunity to be heard concerning those matters. The scope and method of providing services as referenced herein shall also be liberally construed to include, but is not limited to, the manner, procedures, operations and obligations, financial or otherwise, of Contractor. In the event the Port materially alters the obligations of Contractor, or the benefits to the Port, then this Agreement shall be amended consistent therewith. Should these amendments materially alter the obligations of Contractor, then Contractor or the Port shall be entitled to an adjustment in the rates and charges established under this Agreement. Contractor shall be entitled to terminate this Agreement rather than accept modified terms. Nothing contained in this Agreement shall require any party to perform any act or function contrary to law. The Port and Contractor agree to enter into good faith negotiations regarding modifications to this Agreement, which may be required in order to implement changes in the interest of the public welfare or due to changes in law. When such modifications are made to this Agreement, the Port and Contractor shall negotiate in good faith a reasonable and appropriate adjustment for any changes in services or other obligations required of Contractor directly and demonstrably due to any modification in this Agreement under this Section 14.

17. INDEPENDENT CONTRACTOR AND ITS EMPLOYEES

17.1 Status. Contractor acknowledges that in performing services pursuant to this Agreement, Contractor (a) shall be an independent contractor and not an employee of the Port, (b) shall not be entitled to participate in any fringe benefit programs established by the Port for the benefit of its employees, and (c) shall be solely responsible for paying prior to delinquency, and shall indemnify, defend, and hold the Port free and harmless from and against, all income taxes, self-employment taxes, and other taxes (including any interest and penalties with respect thereto) imposed on the fees and compensation paid by the Port to Contractor pursuant to this Agreement.

17.2 Limitation on Authority. Contractor (a) shall not be an agent of the Port and shall have no authority to bind the Port or incur any liabilities in the name of the Port, and (b) shall indemnify, defend, and hold the Port free and harmless from and against all claims, costs, damages, and expenses arising from or related to a breach by Contractor of the limitation set forth in this Section 15.2.

17.3 Port Security Guidelines. In accordance with applicable local and federal rules and regulations, Contractor and its employees or agents must pre-arrange their visits to Port property with a minimum of twenty-four (24) hours advance notice. Such notice shall include Contractor's employee's or agent's names, Social Security or Driver's license numbers, and the time, date, and nature of the anticipated visit. Contractor shall not have access to restricted areas without Port Police clearance or an authorized escort when required. If required, Contractor shall comply with all applicable policies regarding issuance of Port visitor or identification cards. If required, Contractor shall obtain Transportation Workers Identification Credential (TWIC). If Contractor shall operate any vehicles on Port property, Contractor shall comply with all applicable policies regarding maintenance of insurance for vehicles, including submission of vehicle registration and proof of insurance for the vehicles.

18. DISCLOSURE. Contractor hereby represents that it has disclosed to the Port all matters regarding Contractor which if not disclosed to the Port would materially affect the Port's decision to enter into this Agreement with Contractor.

19. DISPOSITION OF PROPERTY AND MATERIALS; INTELLECTUAL PROPERTY RIGHTS

19.1 All plans, outlines, briefs, memoranda, studies, reports, analyses and all other work product and materials incidental or otherwise ("Work Product") which are produced by reason of this Agreement shall be and remain the property of the Port, regardless of whether Contractor is in possession of such Work Product, and may be used by the Port without permission from Contractor and without any additional costs to the Port.

19.2 All Work Products, including any and all intellectual property rights in said Work Product, arising out of this Agreement shall be the sole and exclusive property of the Port. Contractor explicitly acknowledges that the Port possesses exclusive rights to the Work Product arising out of this Agreement. Contractor shall not use or permit others to use in any way or form the Work Product without the express written consent of the Port.

20. EMPLOYMENT OF PERSONS CONVICTED OF A SEX OFFENSE.

Contractor warrants that no person in its employment who has been convicted of a sex offense under the provisions of Chapter 25 of Title 9 of the Guam Code Annotated, or of an offense defined in Article 2 of Chapter 28 of Title 9 of the Guam Code Annotated, or who has been convicted of an offense with the same elements as heretofore defined in any other jurisdiction, or who is listed on the Sex Offender Registry, shall provide services on behalf of the Port while on the Port or Government of Guam property, with the exception of public highways. If any employee or agent of Contractor is providing services on government or Port property and is convicted subsequent to the effective date of this Agreement, then Contractor warrants that it will notify the Port of the conviction within twenty-four (24) hours of the conviction, and will immediately remove and prohibit such convicted person from providing services on government or Port property. If Contractor is found to be in violation of any of the provisions of this Section 18, then Contractor shall take corrective action within twenty-four (24) hours of the notice from the Port, and Contractor shall notify the Port when corrective action has been taken. If Contractor fails to take corrective steps within twenty-four (24) hours of the notice from the Port, then the Port in its sole discretion may suspend the performance of services until corrective action has been taken.

21. MISCELLANEOUS

21.1 Waiver. No waiver by any party of any right on any occasion shall be construed as a bar to or waiver of any right or remedy on any future occasion.

21.2 Severability. If any provision of this Agreement shall be held or deemed by a court of competent jurisdiction to be invalid, inoperative or unenforceable, the remaining provisions herein contained shall nonetheless continue to be valid, operative and enforceable as though the invalid, inoperative or unenforceable provision had not been included in this Agreement.

21.3 Survival of Warranties. All representations, warranties, agreements, covenants and obligations in this Agreement shall be deemed to have been relied upon by the other party, and shall survive the completion of this Agreement and shall not merge in the performance of any obligation by any party hereto.

21.4 Fees and Expenses. Each of the parties shall bear its own expenses in connection with the negotiation and consummation of the transactions contemplated by this Agreement.

21.5 Notices. All invoices, reports, correspondence, notices, requests, demands and other communications hereunder shall be in the English language, in writing. All notices required to be given under this Agreement by either party to the other may be effected by personal delivery, or by mail (registered or certified, postage, prepaid with return receipt requested). Notices delivered personally shall be deemed communicated as of actual receipt. Mailed notices shall be deemed communicated as of the day of receipt or the fifth (5th) day after mailing, which occurs first. Notices shall be addressed and delivered to the parties as follows, provided that each party may change the address by giving the other party written notice in accordance with this Section 19.5:

TO THE PORT:

JOSE D.LEON GUERRERO COMMERCIAL PORT
Attention: Joanne M.S. Brown
1026 Cabras Highway, Suite 201
Piti, Guam 96925

With a copy to the Port's Legal Counsel of Record.

TO CONTRACTOR:

CONSTRUCTION COMPANY
Attention: General Manager/ President
Address:

21.6 Assignment/Subcontractors. It is expressly acknowledged that Contractor is solely responsible for the fulfillment of its duties and obligations under this Agreement, regardless of whether or not Contractor utilizes one or more subcontractors for such purpose. All rights and interest of Contractor under this Agreement (including, but not limited to, Contractor's right to or interest in any part of or all payments under this Agreement) may not be assigned, transferred or subcontracted to any other person, firm, corporation or other entity, whether by agreement, merger, operation of law or otherwise, without the prior, express written consent of the Port. In the event of a permissive subcontract or assignment of this Agreement by Contractor, Contractor agrees that any subcontractors retained by Contractor or assignees shall be subject to all provisions of this Agreement. Contractor agrees that with respect to any agreement entered into by Contractor with a subcontractor to perform any services required hereunder, such agreement shall specifically include the covenants, warranties, prohibitions and requirements set forth in Sections 7, 8, and 9, above.

21.7 Successors and Assigns. This Agreement shall be binding upon, and inure to the benefit of the parties hereto and their respective successors, assigns and transferees, except as otherwise provided for under the terms of this Agreement.

21.8 Entire Agreement; Amendments. This Agreement, the IFB, and the Bid (a) represent the entire understanding of the parties regarding the subject matter hereof, and supersede and replace all prior and contemporaneous understandings regarding the subject matter hereof, whether oral or written, and (b) except as otherwise expressly set forth in this Agreement, may not be modified or amended, except by a written instrument executed by the parties after the effective date of this Agreement.

21.9 Conflicting Terms. In the event of a conflict between the provisions of this Agreement, the IFB, and the Bid, the contradiction shall be resolved by giving precedence in the following order: first, to the provisions of this Agreement (as it may be amended from time to time); second, to the provisions of the IFB; and third, to the provisions of the Bid.

21.10 Effect of Headings. The subject headings of the sections and subsections of this Agreement are included for purposes of convenience only and should not affect construction or interpretation of any of its provisions.

21.11 Counterparts. This Agreement may be executed in multiple counterparts, each of which shall be deemed to be an original and all of which, taken together, shall be deemed to be a single agreement.

21.12 Governing Law; Jurisdiction and Venue. This Agreement shall be governed by and construed in accordance with the laws of Guam. Each party consents to the jurisdiction of the courts of Guam for the purpose of construing or enforcing the rights and obligations created under this Agreement. The exclusive venue for all disputes that arise under this Agreement shall be the Superior Court in and for Guam.

21.13 Computation of Time. Whenever this Agreement provides for a time period of ten (10) days or less, weekends and Government of Guam holidays shall not be included in the computation. When this Agreement provides for a time period exceeding ten (10) days, weekends and Government of Guam holidays shall be included in the computation.

21.14 Remedies. Any dispute arising out of or under this Agreement shall be subject to the provisions of Chapter 9 (Legal and Contractual Remedies) of the Guam Procurement Regulations

**** Approval Signatures will appear on following page ****

IN WITNESS WHEREOF, the parties have executed this Agreement on the date set forth below their respective signatures.

**JOSE D. LEON GUERRERO
COMMERCIAL PORT**

CONSTRUCTION COMPANY

JOANNE M. S. BROWN
General Manager

NAME
Vice-President/General Manager

Date: _____

Date: _____

APPROVED AS TO FORM:

**CERTIFICATION OF AVAILABILITY
OF FUNDS:**

PHILLIPS & BORDALLO LLP
Port Legal Counsel

MIAMI M. ELORDI
Certifying Officer
Jose D. Leon Guerrero Commercial Port

Date: _____

Date: _____

LABOR AND MATERIAL PAYMENT BOND

BOND NO. _____

KNOW ALL MEN BY THESE PRESENTS that _____
as Principal, hereinafter called the "Principal" and _____
(BONDING COMPANY)

a corporation duly organized under the laws of the Territory of Guam, as Surety, hereinafter called "Surety", are held and firmly bound unto the **Port Authority of Guam, Jose D. Leon Guerrero Commercial Port** as Obligee, hereinafter called "Authority" for use and benefit of claimant as herein below defined, in the amount of _____ Dollars (\$ _____), for payment whereof the Principal and Surety bind themselves, their heirs, executors, administrators, successors and assigns, jointly and severally, firmly by these presents.

WHEREAS, the Principal has by written Agreement dated _____, 20____,
Entered into a Contract with the Authority for the Project Titled:

IFB-PAG-CIP-018-004 Design Build to Supply and Install Steel and Aluminum Poles with LED or Solar Lighting Fixtures

in accordance with drawings and specifications prepared by the Authority, which contract is by reference made a part hereof, and is hereinafter referred to as the Contract.

NOW, THEREFORE, THE CONDITION OF THIS OBLIGATION is such that if the Principal shall promptly make payment to all claimants as hereinafter defined, for all labor and material used or reasonably required for use in the performance of the Contract, then this obligation shall be void; otherwise it shall remain in full force and effect, subject, however, to the following conditions:

1. A claimant is defined as one having a direct Contract with the Principal or with a subcontractor of the Principal for labor, material, or both, used or reasonably required for use in the performance of the contract, labor and material being construed to include that part of water, gas, power, light, heat, oil, gasoline, telephone service or rental of equipment directly applicable to the Contract.
2. The above-mentioned Principal and Surety hereby jointly and severally agree with the Authority that every claimant as herein defined, who has not been paid in full before the expiration of a period of ninety (90) days after the date on which the last of such claimant, may sue this Bond for the use of such claimant, prosecute the suit to final judgment for such sum or sums as may be justly due claimant, and have execute thereon. The Authority shall not be liable for the payment of any costs or expenses of any such suit.

3. No suit or action shall commence hereunder by any claimants:

- A. Unless claimant, other than one having a direct Contract with the Principal, shall have given written notice to any two of the following: The Principal, the Authority, or the Surety above named, within ninety (90) days after such claimant did or performed the last of the work or labor, or furnished the last of the materials for which said claim is made, starting with substantial accuracy the amount claimed and the name of the party to whom the materials were furnished, or for whom the work or labor was done or performed. Such notice shall be served by mailing the same by registered mail or certified mail, postage prepaid, in an envelope addressed to the Principal, Authority or Surety, at any place where an office is regularly maintained for the transaction of business, or serves in any manner in which legal process may be served in Guam in which the aforesaid project is located, save such service need not be made by public officer.
- B. After the expiration of one (1) year following the date on which the last of the labor was performed or material was supplied by the party bringing suit.
- C. Other than in court of competent jurisdiction for the county or district in which the construction contract was to be performed.

4. The amount of this bond shall be reduced by and to the extent of any payment or payments made in good faith hereunder, inclusive of the payment by Surety of mechanics' liens which may be filed of record against said improvement, whether or not claim for the amount of such lien be presented under and against this bond.

SIGNED AND SEALED this _____ day of _____, 20_____.

(WITNESS)

(PRINCIPAL)

(TITLE)

(SEAL)

(WITNESS)

(BONDING COMPANY)

(TITLE)

By: _____

(ATTORNEY-IN-FACT)

PERFORMANCE BOND

BOND NO. _____

KNOW ALL MEN BY THESE PRESENTS that _____
(Insert full name and address or legal title of Contractor)

as Principal, hereinafter called Contractor and _____
(Bonding Company)

a corporation duly organized under the laws of the Territory of Guam, hereinafter called Surety, are held and firmly bound unto the **Port Authority of Guam, Jose D. Leon Guerrero Commercial Port** as Obligee, herein after called the "Authority" for use and benefit of claimants as herein below defined, in the amount of _____ Dollars (\$ _____), for the payment whereof Contractor and Surety bind themselves, their heirs, executors, administrators; successors and assigns, jointly and severally, firmly by these presents.

WHEREAS, the Contractor has by written Agreement dated _____, 20____, entered into a Contract with the Authority for the Project Titled:

IFB-PAG-CIP-018-004 Design Build to Supply and Install Steel and Aluminum Poles with LED or Solar Lighting Fixtures

in accordance with drawings and specifications prepared by the Authority which contract is by reference made a part hereof, and is hereinafter referred to as the Contract.

NOW, THEREFORE, THE CONDITION OF THIS OBLIGATION is such that, if the Contractor shall promptly and faithfully perform said contract then this obligation shall be null and void; otherwise it shall remain in full force and effect. The Surety hereby waives notice of any alteration or extension provided the same is within the scope of the contract. Whenever Contractor shall be and is declared by the Authority to be in default under the Contract, the Authority having performed territorial obligations thereunder, the Surety may promptly remedy the defaults or shall promptly;

1. Complete the Contract in accordance with its terms and conditions; or
2. Obtain a bid or bids for completing the Contract in accordance with its terms and conditions, and upon determination by the Authority and the Surety jointly of the lowest responsive, responsible Bidder, arrange for a Contract between such Bidder and the Authority, and make available as work progresses (even though there should be a default or a succession of defaults under the Contract or Contracts of completion arranged under this paragraph) sufficient funds to pay the cost of completion less the balance of the Contract Price; but not exceeding, including other costs and damages for which the Surety may be liable hereunder, the amount set forth in the first paragraph hereof. The term "balance of the contract price", as used in this paragraph shall mean the total amount payable by the Authority to Contractor under the Contract

and any amendments thereto, less the amount properly paid by the Authority to Contractor. No right of action shall accrue on this bond to or for the use of any person or corporation other than the Authority or successors of the Authority.

SIGNED AND SEALED this _____ day of _____, 20_____.

(WITNESS)

(TITLE)

(PRINCIPAL)

(SEAL)

(WITNESS)

(BONDING COMPANY)

(TITLE)

BY: _____
(ATTORNEY-IN-FACT)

VOLUME 5
SCOPE OF WORK/SPECIFICATION/DRAWINGS

SCOPE OF WORK

PROJECT DESCRIPTION:

This is a design build project to supply and install new 4 ea. 40 ft. hot dipped galvanized steel pole with one 133 watts 277Volts single arm LED light fixtures and 7 ea. new 20ft. aluminum pole with double arm 100 watts LED solar power lighting fixtures and 5 ea. new 20ft. aluminum pole with single arm 100 watts LED solar power lighting fixtures and 3 Ea. new 480 Watts LED flood Light Fixtures at Port Authority of Guam various locations.

All system shall meet the standard compliance of organizations for the American National Standard Institute (ANSI), American Society for Testing & Materials (ASTM), Underwriter Laboratories (UL), National Electrical Manufacturers Association (NEMA), National Electrical Code (NEC), & Occupational Safety & Health Association (OSHA).

A) DESIGN-BUILT SCOPE OF WORK:

The Port Authority of Guam will award this project through a competitive sealed bidding. This is a design/build project to remove, supply and install new four (4) ea. 40 ft. hot dipped galvanized steel pole with one (1) ea. 133 watts 277 Volts single arm LED lighting fixtures per pole south of Administration Building parking lot, new seven (7) ea. 20ft. aluminum pole with double arm with 1 ea. 100 watts LED solar power lighting fixtures per pole at PAG Industrial Ave., two (2) ea. 20ft. aluminum pole with single arm one (1) ea. 100 watts LED solar power lighting fixtures at Seaplane Ramp, two (2) ea. new 20ft. aluminum pole with single arm one (1) ea. 100 watts LED solar power lighting fixture at PAG Compound Wash Rack Area, two (2) ea. new 480 watts LED Flood Light Fixtures mount on top of Port Police Building facing Wash Rack Area and 1 ea. new 20ft. aluminum pole with single arm one (1) ea. 100 watts LED solar power lighting fixtures SCUBA Diving Area and one (1) ea. 480 Watts LED flood light fixtures to be installed to the existing concrete light pole south of CEMENTON Area. Duration for this project is Eight (8) months from the issuance of Notice to Proceed and Building permit, ending of construction and acceptance of the project by the Port Authority of Guam.

The contractor must be the prime bidder on this project that meets the Port's requirements & credibility. Bid shall be lump sum cost which will include drawing plans, specifications certify by registered engineer, construction cost and DPW Building Permit.

Prospective bidders are encouraged to visit the project site after the pre-bid conference. Call for the final site visit schedule coordinated by the Port's Engineering/CIP Division at Tel. # 477-5931-35, ext. 415, 418, & 433.

B) A/E DESIGN PARAMETERS:

- 1) Attached are the existing As-Built plans and photos compiled by the Port Engineering/CIP Division for bid purposes, and for A/E consultant to follow for their basis of design;
- 2) The contractor that is awarded on this project shall obtain the services of an electrical consultant licensed by the PEALS Board of Guam, to develop drawing plans, specifications and compute electrical loads for the new 277 Volts LED lighting fixtures of the four (4) new 40ft. hot dipped galvanized steel pole carbon steel construction with weather shield coating, rust grip for corrosive resistance and to the new twelve (12) ea. new 20ft. aluminum pole with 100 watts LED solar lights, panels, batteries, chargers and accessories for this project. All new poles shall with stand a minimum wind velocity of 190 MPH;
- 3) A/E consultant shall expound/upgrade the design plans of the new four (4) ea. 40ft. hot dipped galvanize steel pole carbon steel construction with weather shield coating, rust grip for corrosive resistance and for a new designed twelve (12) ea. new 20ft. aluminum pole for solar lighting fixtures, solar panels, chargers and batteries shall have a minimum twelve (12) hours running load capacity, provide electrical load computations to be energy compliance and shall meet the Government of Guam regulatory requirements for a building permit approval;
- 4) A/E consultant to design new footing foundation of the twelve (12) new 20ft. aluminum pole, seven (7) each in Industrial Avenue, two (2) in Seaplane Ramp two (2) in PAG Compound Wash Rack Area and one (1) in SCUBA Diving Area. All twelve (12) new aluminum poles shall with stand a minimum wind velocity of 190 MPH. No existing as-built in this area. See attached site plan and photos. All seven (7) existing concrete footing in Industrial Avenue is to be abandon in place.
- 5) A/E consultant to modify existing footing foundation designed of the four (4) 40 ft. existing galvanized light pole south of Administration Bldg. parking lot. Provide A/E repair detail for new anchor rods to erect new four (4) ea. hot dipped galvanized steel pole.
- 6) Drawing plans shall have but not be limited to the following:
 - a) Title sheet, location map, vicinity map, project location, & index of drawings;
 - b) Drawing shall indicate the location of new concrete light poles, lighting control, lighting contactor, photocell, new wirings size and circuit runs, circuit breakers, solar panels, battery packs and accessories;
 - c) Specifications & general construction notes can be indicated on the drawing plans. This project must conform to the code requirements on ANSI, ASTM, UL, NEMA, NEC, & OSHA;
 - d) Port Engineering/CIP Division shall review the design plans at 65%, 100%, & Final Design. Submit Four (4) sets of standard size 24" x 36" design plans per review. Upon PAG approval of the Final Design plans, contractor to apply for the building permit. Design plans and specifications including the building permit shall be completed within Sixty (60) calendar days;

C) GENERAL REQUIREMENTS;

- 1) The contractor shall investigate the project site prior to bidding, verify existing conditions and measurements. Failure to do so shall not be cause for additional claims against PAG. Any work related to conditions not reflected on the design drawing shall be performed at the contractor's expense;
- 2) Contractor shall provide all labors, materials and equipment to supply and install the aforementioned project. PAG will then issue the Intent to Award base on the lowest responsible responsive bid. Official Notice to Proceed will be issued to the contractor once Building permit was issued by DPW.
- 3) After Port issued the Intend to Award notice to the selected contractor, Contractor to start the required submission of the Performance & Payment Bonds as required by procurement and for processing the Transportation Worker Identification Credential (TWIC).
- 4) Within Seven (7) days from the NTP issuance, contractor shall process for submission of the insurance coverage on Comprehensive General Liability, Excess Liability Policy (\$1M minimum), Workers Compensation & Employers Liability, and Builder's Risk. PAG shall be an additional insured;
- 5) Within Fifteen (15) days from the NTP issuance, the contractor shall process to submit the 65% Design Plans, Submittal Status Log, Material Submittals, Schedule of Values, Computation of Load Analysis, & Construction Schedule for approval to the Port Engineering/CIP Division. Contractor has Eight (8) months or Two Hundred Forty-Three (243) calendar days to complete this project;
- 6) All submittals shall be stamp approved by the A/E Consultant and with concurrence by the Port Engineering Office;
- 7) Contractor's personnel assign in this project are required to have a TWIC card and the mandatory MARSEC Level briefing attendance. Inquire the Port Police Office on these requirements. No work will commence without the DPW permit and TWIC cards;
- 8) The contractor shall be responsible for the daily clean-up of project vicinity. Removed existing steel poles wires, light fixtures & other construction debris shall be disposed to a designated DPW dump site at no cost PAG;
- 9) Contractor to work with the approved design drawing plans and conform to specifications on this project. The contractor shall conduct a scheduled weekly progress meeting. Venue & time shall be discussed on a later date;

- 10) Contractor to provide concrete barriers & safety warning signs around the vicinity of the work site. Provide flashing lights for night time safety warning;
- 11) Port Engineering Office will conduct daily site inspection on the project site. Coordinate all work with the Engineering/CIP Division;
- 12) The contractor shall request in writing for a final inspection to the Engineering Office;
- 13) Contractor to submit billing statement on a monthly basis with a 10% retention, to be released upon completion of the project. Monthly billing shall have the Billing Invoice, Cost Breakdown, Schedule of Values, & a copy of Purchase Order;
- 14) The contractor upon correction of all punch list and approval by the Engineering Office, shall submit the Final Invoice & the close-out documents;
- 15) Submit a Hard copy and CD file in PDF format for the close-out documents. Close-out documents shall have the As-Built Drawings, Certificate of Completion, Warranty Certificate, and Release of Liabilities to PAG associated with this project;

D) COSTRUCTION SCOPE OF WORK;

Four (4) Ea. New 40 ft. Hot Dipped Galvanized Steel Pole with 277 Volts 133 Watts Single Arm LED Light Fixture South of Administration Bldg. Parking Lot;

- 1) Contractor to investigate and verify site condition prior to removal of four (4) existing 50ft. hot dipped galvanized poles and exiting pole base.
- 2) Contractor to tag-out light pole's 277 Volts circuit breakers and circuit runs inside LC-1 building panel board prior to removing circuit wires and the existing four (4) each steel light poles;
- 3) Contractor to run new circuit feeder line approximately 1,500 L.F. to panel 480/277 volts and control timers base on the approved designed by A/E consultant and PAG Engineering; (see panel schedule)
- 4) Contractor to re-use existing PVC conduit pipes, mandrel conduits prior in pulling new circuit wires run approximately 1,500 L.F. Contractor to coordinate with PAG Engineering to witness mandrel of electrical conduits;
- 5) Contractor to perform megger test to the new 277 Volts circuit wire runs. Submit megger test result to PAG Engineering office.
- 6) Contractor to modify concrete pole footing, based on the A/E design repair detail to install new 4 ea. anchor rods per pole to erect and install new 40ft. hot dipped galvanized steel pole carbon

steel construction with weather shield coating, rust grip for corrosive resistance with single arm
1 ea. new designed LED lighting fixtures south of Administration Bldg. parking lot.

- 7) Contractor to run new circuit wire line approximately 240 L.F of the existing 40 ft. LED light pole west side of Administration Bldg. and connect to the new pole no.4 and energized.
- 8) Contractor to energize and test run all new LED light fixtures 24 hrs. continuously for observation.

Seven (7) Ea. 20 ft. Aluminum Pole at Industrial Ave. with Double Arm with One (1) Ea. 100 watts LED New Solar Light Fixtures Per Pole;

- 1) Contractor to remove existing 5 ea. aluminum street light pole and two (2) ea. damage pole base. All existing wires to be remove from the conduit and cap end conduit. All existing concrete footing to be abandon in place;
- 2) Contractor to investigate and verify site condition and new location prior to excavate new designed concrete footing foundation of the new 20ft. aluminum solar pole;
- 3) Contractor and PAG Engineering to coordinate with Tristar, South Pacific Petroleum Corporation, Cabras Marine, United Fisheries and tenants in regards to the crossing utilities and installation of new footing foundation of 20ft. aluminum solar pole in Industrial Avenue;
- 4) Contractor to verify crossing utilities as-built during excavation. Contractor to take extra careful during excavation assigned spotter as possible to prevent any damage on the project site.
- 5) New concrete footing foundation shall be cured in minimum of 21 calendar days before installation of newly designed 20 ft. aluminum with one (1) ea. 100 watts LED solar lights fixtures, solar panels, batteries, chargers and accessories per pole;
- 6) Contractor to request for inspection before energizing solar light fixtures.

Two (2) Ea. 20 ft. Aluminum Pole at Sea Plane Ramp with Single Arm One (1) ea. 100 watts LED New Solar Light Fixtures;

- 1) Contractor to investigate and verify site condition prior to excavate new designed concrete footing foundation and anchoring of the new 20ft. aluminum pole;
- 2) Contractor to erect and install new designed 20 ft. aluminum pole with single arm one (1) ea. 100 watts LED solar lighting fixtures, solar panels, batteries, chargers and accessories once concrete curing of the new footing foundation is obtained.
- 3) Contractor to request inspection from PAG Engineering before energizing.

One (1) Ea. 20ft. Aluminum pole at Scuba Diving AREA with Single Arm one (1) ea. 100 watts LED New Solar Light Fixtures;

- 1) Contractor to investigate and verify site condition prior to excavate new designed concrete footing foundation and anchoring of the new 20ft. aluminum pole;
- 2) Contractor to erect and install new designed 20 ft. aluminum pole with single arm one (1) ea. 100 watts LED solar lighting fixtures, solar panels, batteries, chargers and accessories once concrete curing of the new footing foundation is obtained.
- 3) Contractor to request inspection from PAG Engineering before energizing.

One (1) Ea. New 480 Watts LED Flood Light Fixtures South of CEMENTON Area;

- 1) Contractor to investigate and verify site condition prior to removal of the existing flood light fixtures and verify power source.
- 2) Contractor to install new 480 watts LED flood light fixtures to the existing concrete pole and reconnect to the existing power source;
- 3) Contractor to request inspection from PAG Engineering before energizing.

Two (2) Ea. New 20 ft. Aluminum Pole at PAG Compound Wash Rack Area with Single Arm One (1) ea. 100 watts LED New Solar Light Fixtures and two (2) ea. new 480 watts LED Flood Light Fixtures on top of Port Police Roof Eaves;

- 1) Contractor to investigate and verify site condition prior to excavate new designed concrete footing foundation and anchoring of the new 20ft. aluminum pole;
- 2) Contractor to erect and install new designed 20 ft. aluminum pole with single arm one (1) ea. 100 watts LED solar lighting fixtures, solar panels, batteries, chargers and accessories once concrete curing of the new footing foundation is obtained.
- 4) Contractor to install new two (2) ea. 480 watts LED Flood Light fixtures to be mount on top of Port police building facing Wash Rack area. Contractor install conduit pipes, wires and 4"x4" weatherproof junction box and tap to the existing power line of the flood light fixtures.
- 5) Contractor to request inspection from PAG Engineering before energizing.

SITE PLAN OF LIGHT POLE FIXTURES



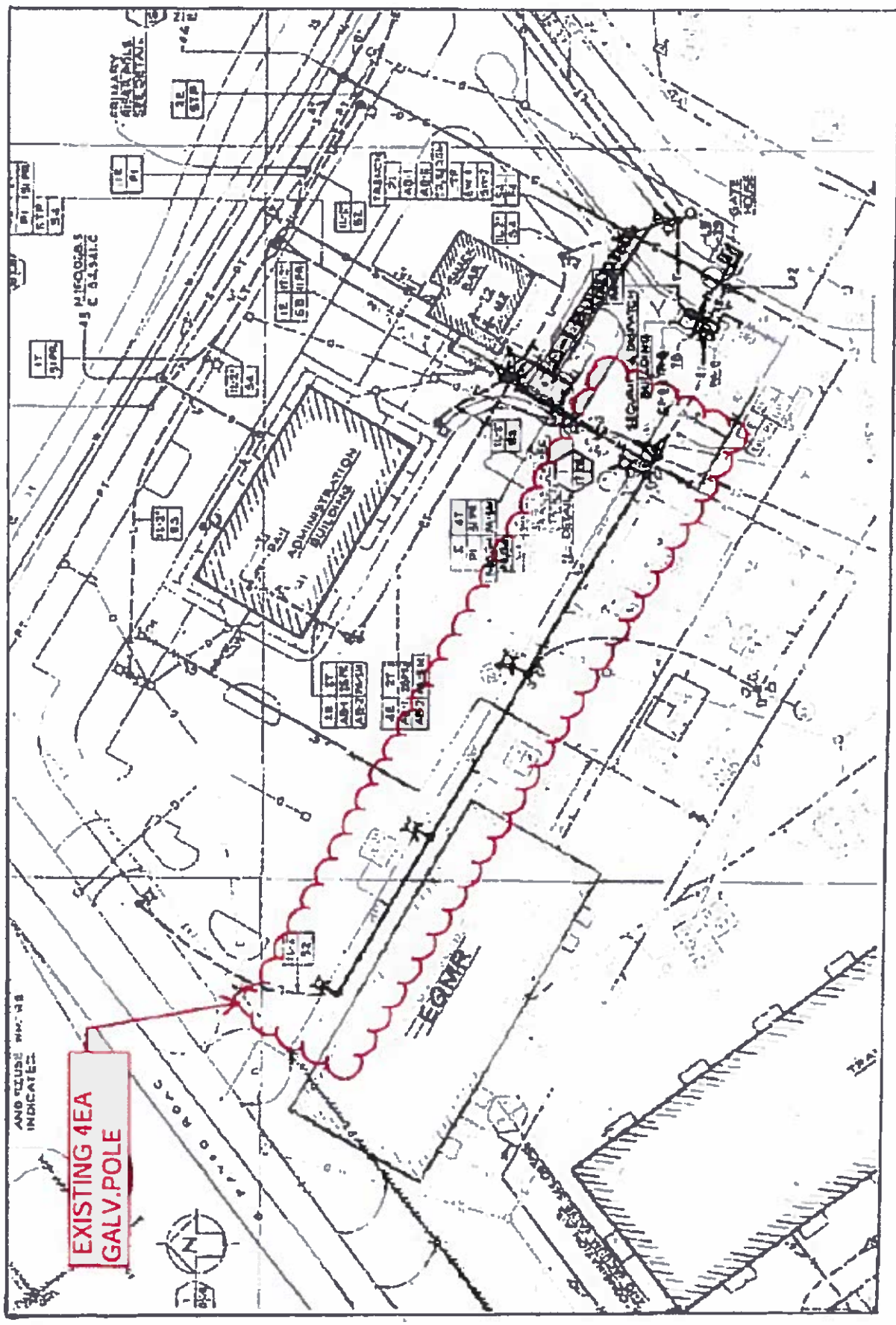

SITE/LAY-OUT PLAN OF 4EA EXISTING LIGHT GALVANIZED POLE,SOUTH OF ADMIN.BLDG PARKING LOT

EXISTING 40 FT. LED GALVANIZED POLE WEST
SIDE TO CONNECT AND ENERGIZED

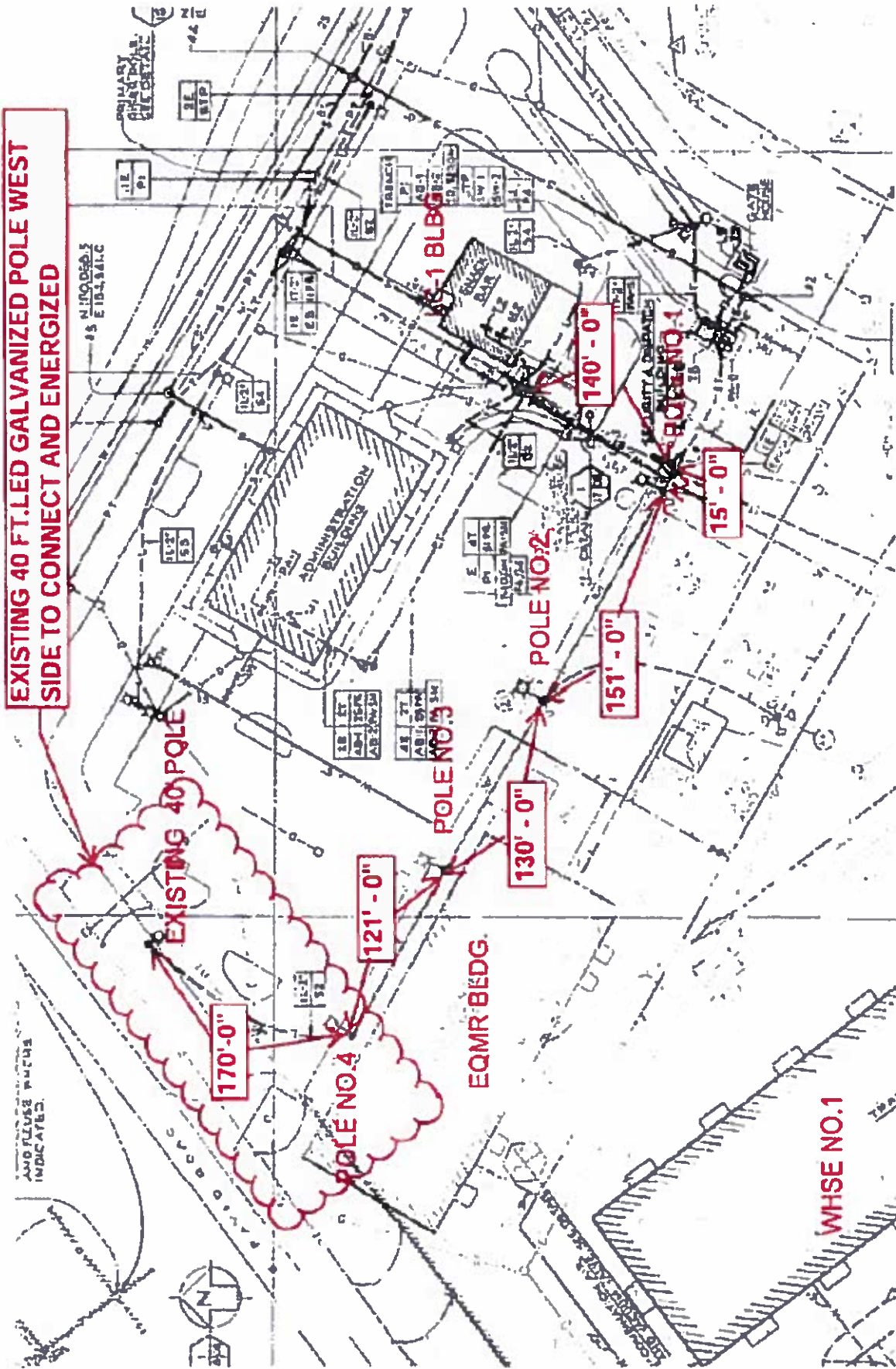

SITE/LAY-OUT PLAN OF EXISTING 40 ft. LED GALVANIZED POLE, WEST SIDE OF ADMIN. BLDG. PARKING LOT

LC-1 BUILDING ELECTRICAL PANEL 480V/277



MAIN PANEL



4LP



STREET LIGHT PANEL

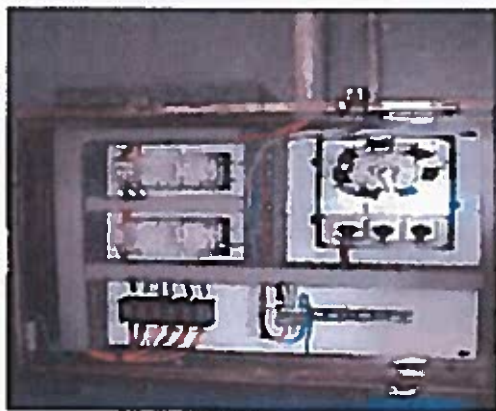

TIMER



TIMER PANEL



MAIN BREAKER



480V/277



LC-1 INSIDE ELECTRIC BREAKERS AND PANELS

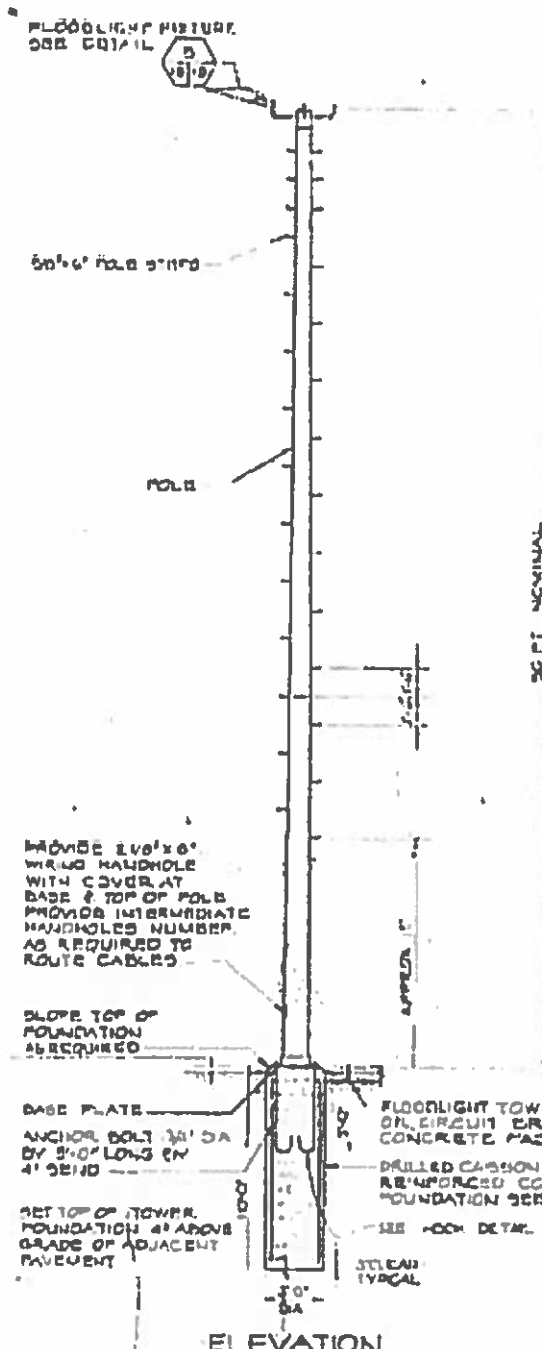

ELEVATION
FLOODLIGHT TOWER
POLE DETAIL
NO SCALE

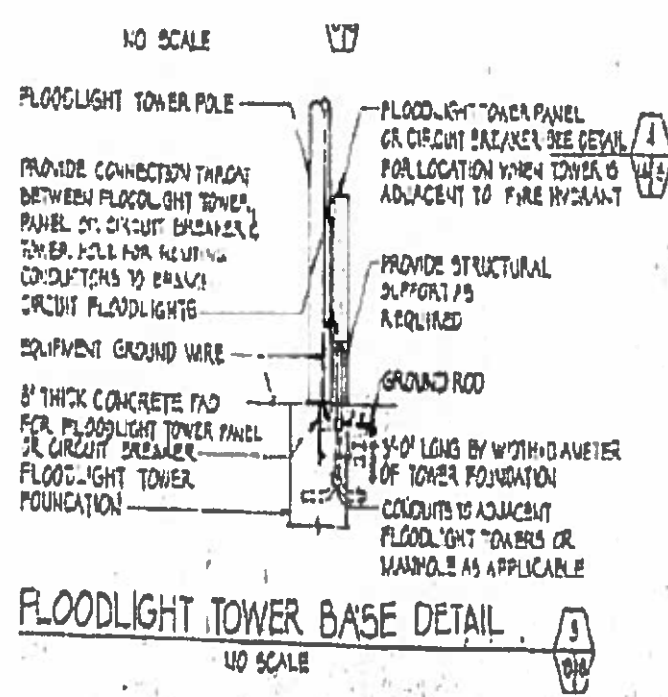

HOOK DETAIL
FOR 1 1/2" DIA BOLT
NO SCALE

EXISTING FLOODLIGHT TOWER POLE TO REMOVE

SITE PLAN OF INDUSTRIAL AVENUE ROAD



INDUSTRIAL AVENUE ROAD AT CABRAS MARINE

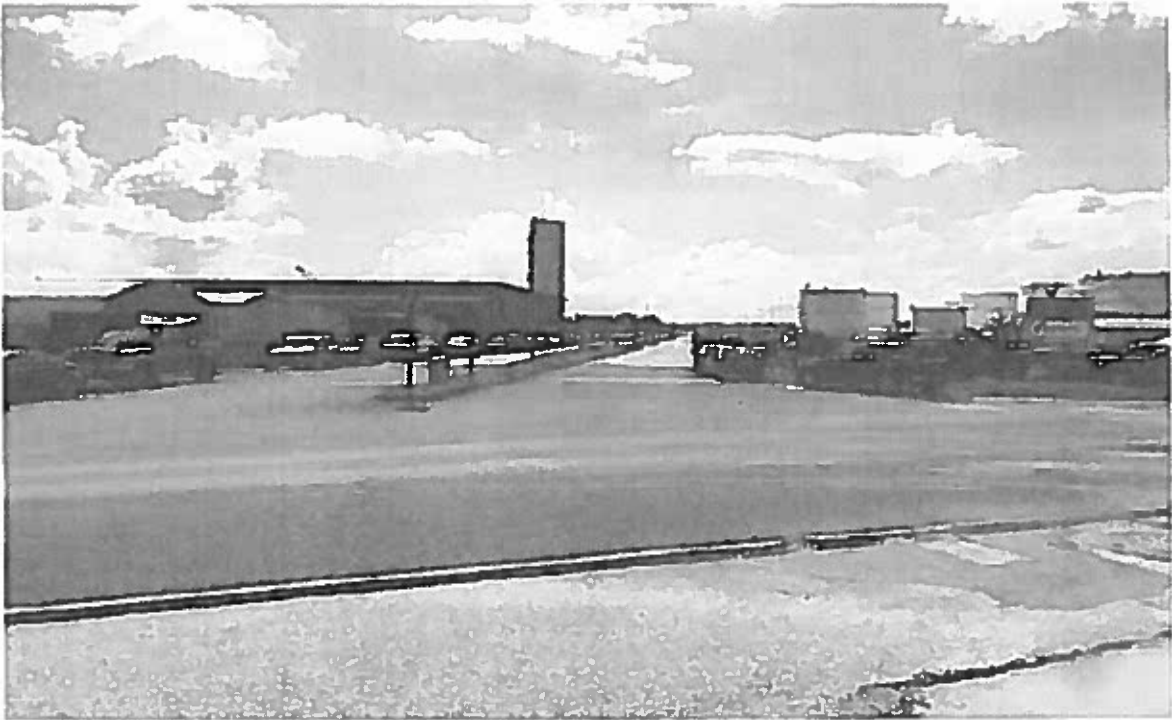

EXISTING FOOTING FOUNDATION AT INDUSTRIAL AVENUE.



PROPOSE DOUBLE SOLAR LIGHT FIXTURE (CONCEPTUAL)

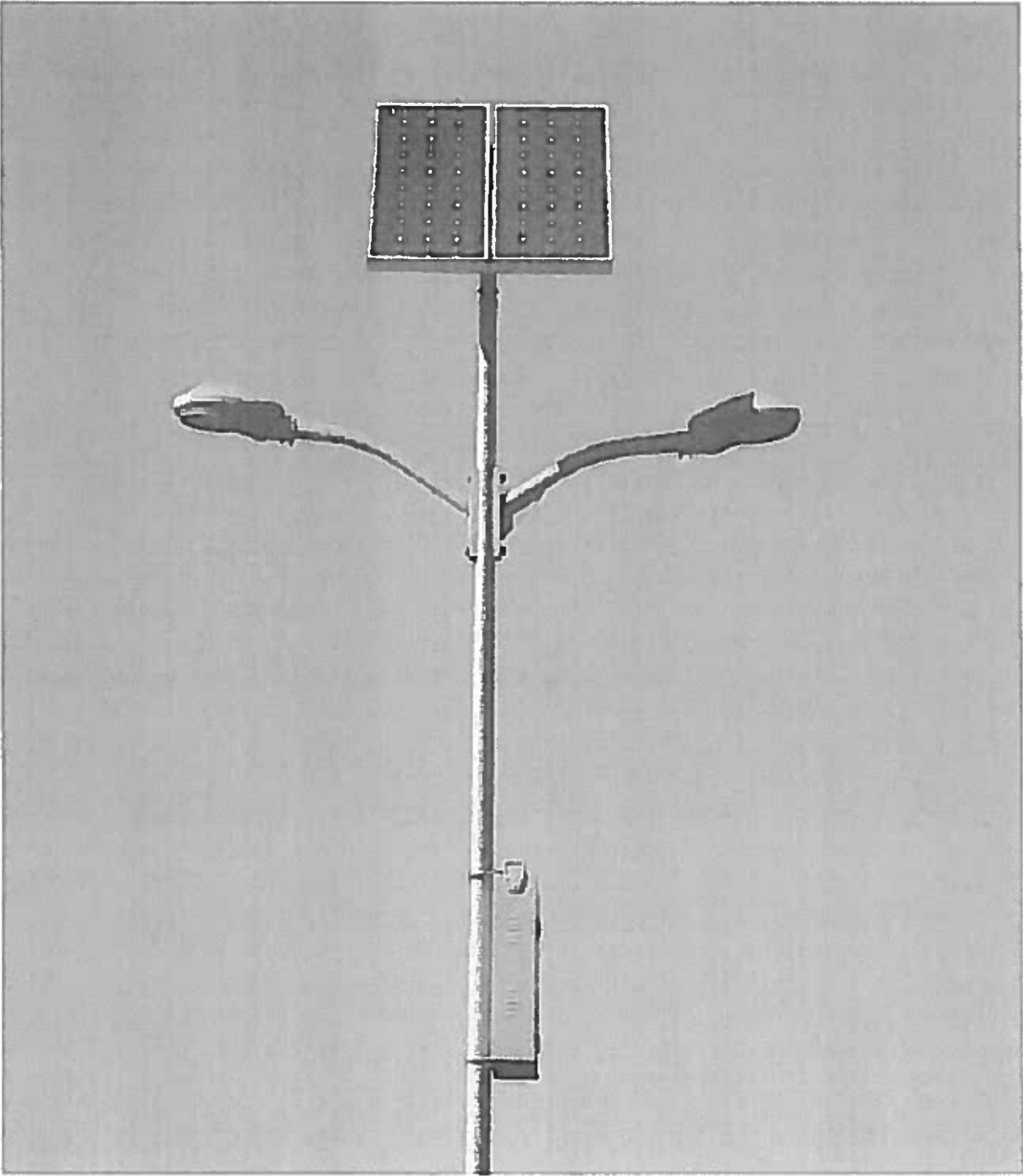

NEW PROPOSAL STREET LIGHT ALUMINUM POLE

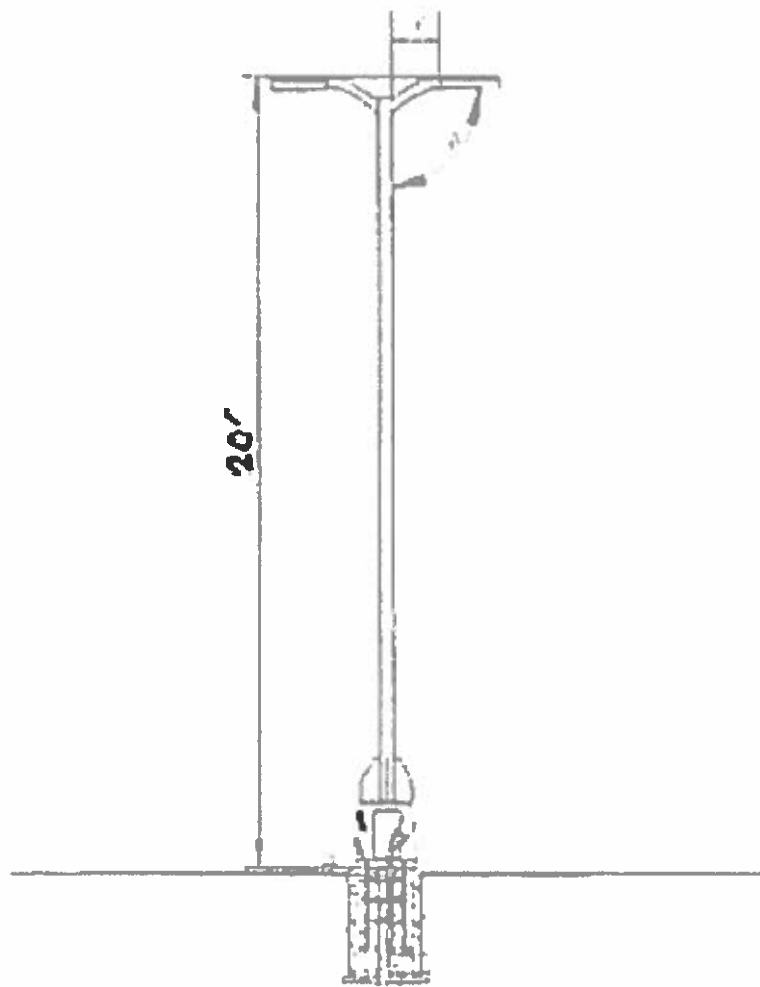

STREET LIGHT POLE
SCALE: NTS

SITE LOCATION SEA PLANE RAMP



ROUTE 11



ENTRANCE ROAD



EXISTING BOLLARD AT SEA PLANE RAMP

PROPOSE SOLAR SINGLE ARM LIGHT POLE (CONCEPTUAL)



Existing Light Post At Cementon

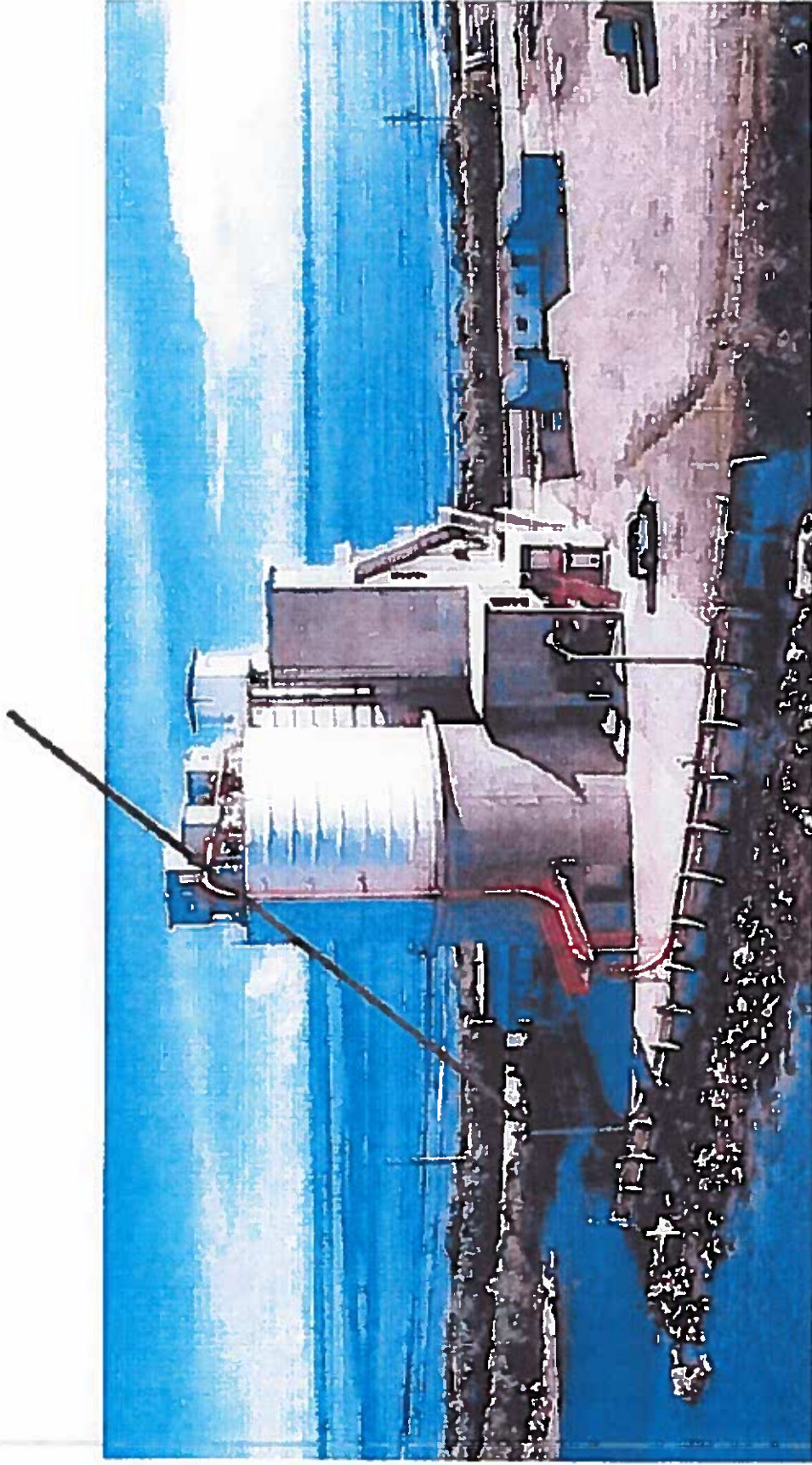

Site Plan

CEMENTON MICRONESIA EXISTING LIGHT POLE



EXISTING BOLLARD



CEMENTON EXISTING LIGHT POLE

PROPOSE 480 WATTS LED FLOOD LIGHT FIXTURES (CONCEPTUAL)



SITE / LOCATION SCUBA AREA



PROPOSE SOLAR SINGLE ARM LIGHT POLE (CONCEPTUAL)





NORTH

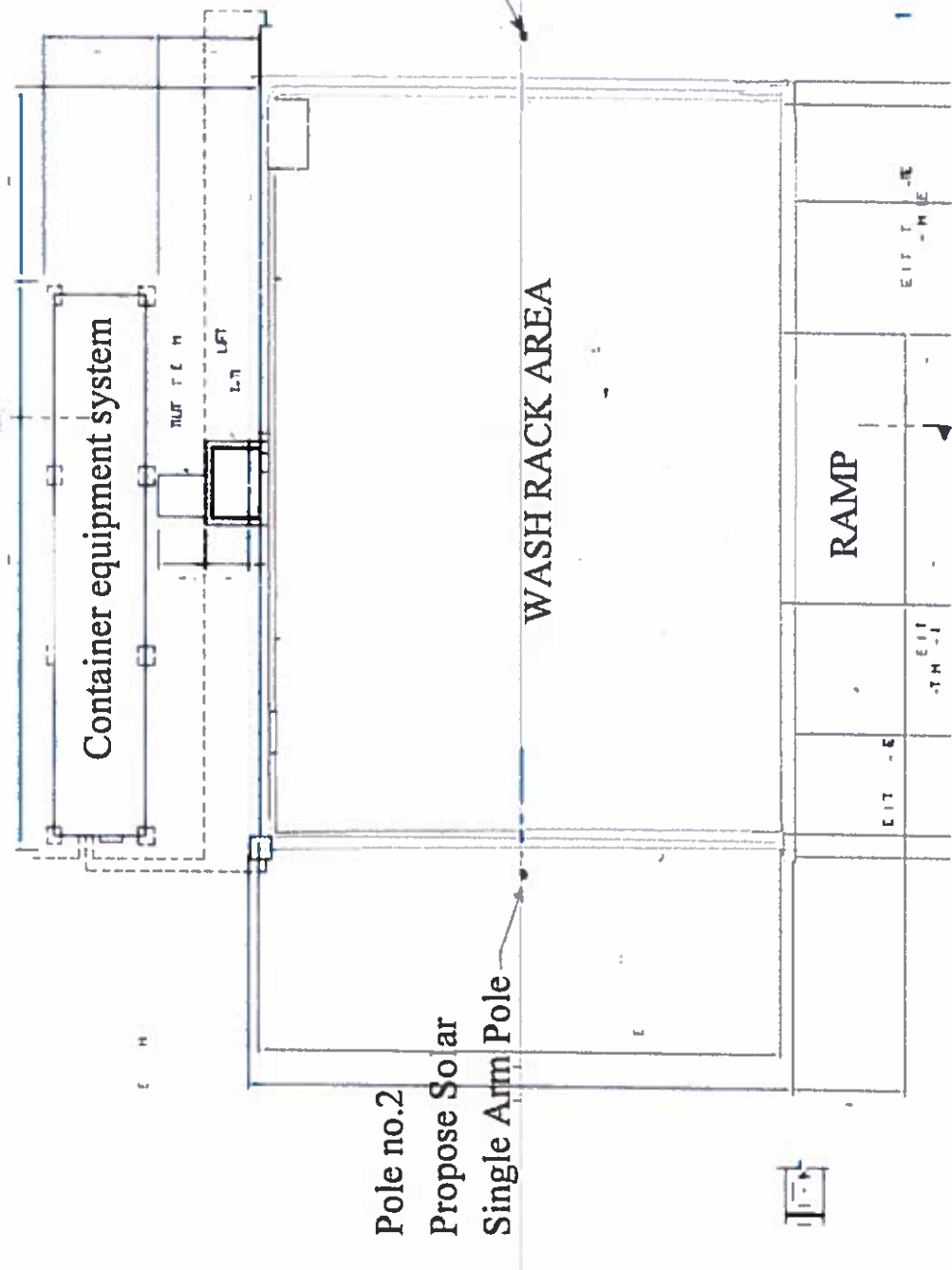

Pole no.1
Proposed Solar
Single Arm Pole

Pole no.2
Propose Solar
Single Arm Pole

WASH RACK PLAN
-LE

SITE/LAY-OUT PLAN OF PAG COMPOUND WASH RACK AREA

PORT POLICE BUILDING



PROPOSE 480 WATTS LED FLOOD LIGHT FIXTURES (CONCEPTUAL)